

FLOW RATE INDICATOR / TOTALIZER

WITH LINEARIZATION AND PULSE
SIGNAL OUTPUT



Advantages

- Robust IP67 (NEMA4X) field enclosure. It is so rugged, **you can even stand on it!**
- Intrinsically Safe available - ATEX, IECEx, FM and CSA approval for gas and dust applications.
- Programming can be done by your own crew, with the sensible menu-driven structure, saving cost and irritation. **Know one, know them all!**
- Very diverse mounting possibilities: walls, pipes, panels or directly onto outdoor sensors!

Features

- Displays instantaneous flow rate, total and accumulated total.
- Eight point linearization of the flowcurve - with interpolation.
- Large 17mm (0.67") digits for flow rate or total.
- Auto backup of settings and running totals.
- Explosion/flame proof $\text{Ex} \text{II} \geq \text{GD EEx d IIB T5}$.
- LED backlight option.
- Battery powered, 8 - 24V AC/DC or 115 - 230V AC power supply.
- Sensor supply 3.2 / 8.2 / 12 / 24V DC.

Signal output

- Scaled pulse output according to linearized accumulated total.

Signal input

Flow

- Ability to process all types of flow meter signals: Reed-switch, NAMUR, NPN/PNP pulse, Sine wave (coil), Active pulse signals.

Applications

- The F-Series is your first and safest choice for field mount indicators. Especially in harsh weather conditions like rain, snow, salty atmospheres and temperatures between -40°C up to +80°C (-40°F up to 176°F) for safe and hazardous area applications!
- Liquid flow measurement with mechanical flow meters where a precise calculation over the full measurement range is required. Also re-transmission of the totalizer function is desired. Alternative more advanced models: F112 - F118 or the D-Series DIN panel mount flow rate indicators.

General information

Introduction

The Fo16 is a local indicator with linearization to display the actual flow rate, total and non-resettable accumulated total. In addition to the average K-Factor or Span, eight linearization points can be entered with their frequencies or values. The unit will interpolate between these points greatly enhancing accuracy in any flowrange. Even for very low frequency applications is catered for. This linearization affects all displayed information as well as the pulse output. A wide selection of options further enhances the capabilities of this model, including Intrinsic Safety.

Display

The display has large 17mm (0.67") and 8mm (0.31") digits which can be set to show flow rate and totals. On-screen engineering units are easily configured from a comprehensive menu. The accumulated total can register up to 11 digits and is backed-up in EEPROM memory every minute, just as the running total. A smart display update function achieves a readable display even at -40°C / -40°F.

Backlight

For those applications where readability during day and night is an issue, a bi-color backlight is available. The background color green or amber and the intensity can be adjusted from the keyboard. The display is a transfective type, which means that a high contrast reading is guaranteed in full sunlight as well as during the night. This backlight option is also available Intrinsically Safe.

Configuration

All configuration settings are accessed via a simple operator menu which can be password protected. Each setting is clearly indicated with an alpha-numerical description, which avoids confusing abbreviations. Once familiar with one F-series product, you will be able to program all models in the series without a manual.

Pulse output

The scaleable pulse output reflects the count on the accumulated display. The pulse length is user defined from 0.001 second up to 10 seconds. The maximum output frequency is 500Hz. The output

signal can be a passive NPN or an active PNP transistor, or an isolated electro-mechanical relay.

Signal input

The Fo16 accepts most pulse input signals for volumetric flow or mass flow measurement. The input signal type can be selected by the user in the configuration menu without having to adjust any sensitive mechanical dip-switches, jumpers or trimmers.

Hazardous area

For hazardous area applications, this model has been ATEX, IECEx, FM and CSA certified Intrinsically Safe for gas and dust applications, with an allowed ambient temperature of -40°C to +70°C (-40°F to +158°F). A flame proof enclosure with ATEX certification offers the rating Ex II 2 GD EEx d IIB T5.

Enclosures

Various types of enclosures can be selected, all ATEX, IECEx, FM and CSA approved. As standard the Fo16 is supplied in an GRP panel mount enclosure. Most popular is our aluminum field mount enclosure with IP67 / NEMA 4X rating. Both European or U.S. cable gland entry threads are available.

Overview application Fo16

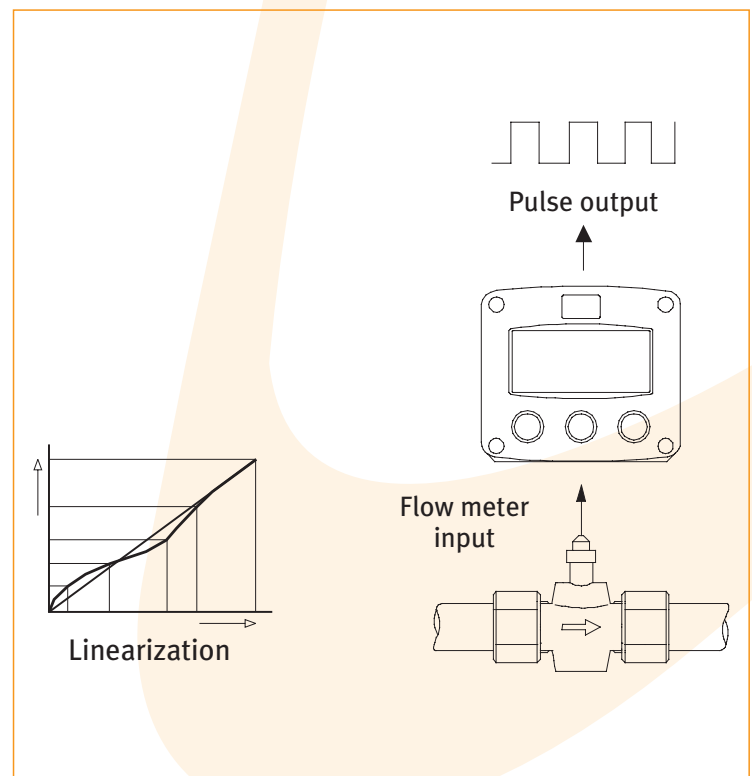

Dimensions enclosures Aluminum & GRP panel mount enclosure

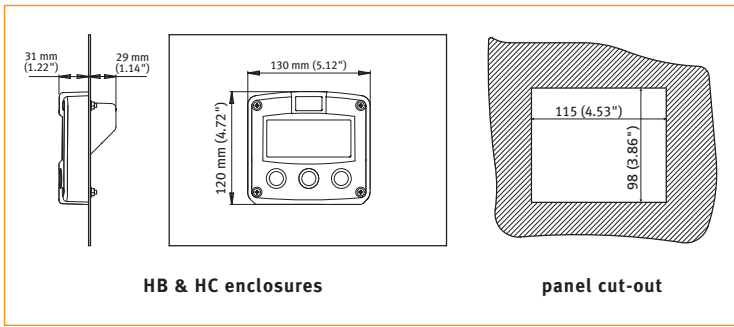

Aluminum & GRP field / wall mount enclosures

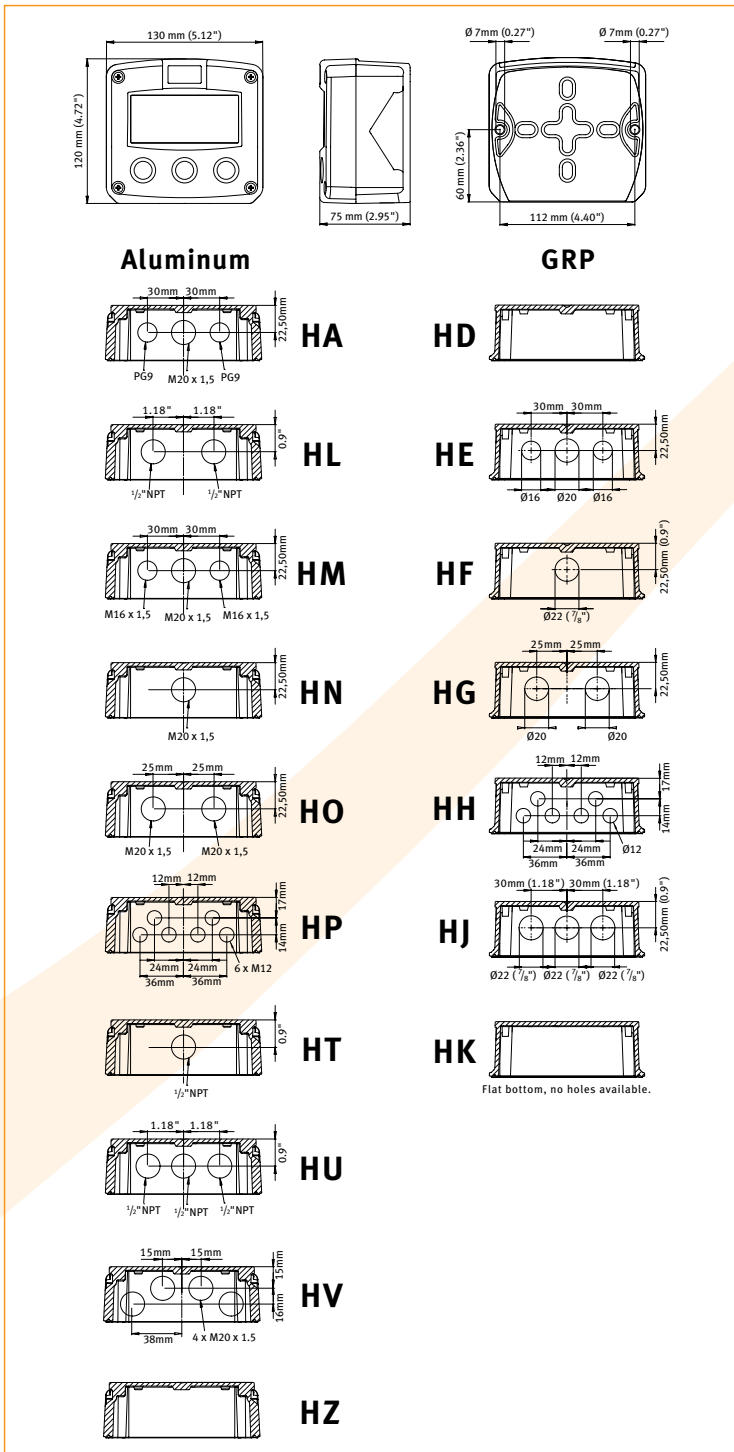

Terminal connections PB/PC - PD - PL - PX

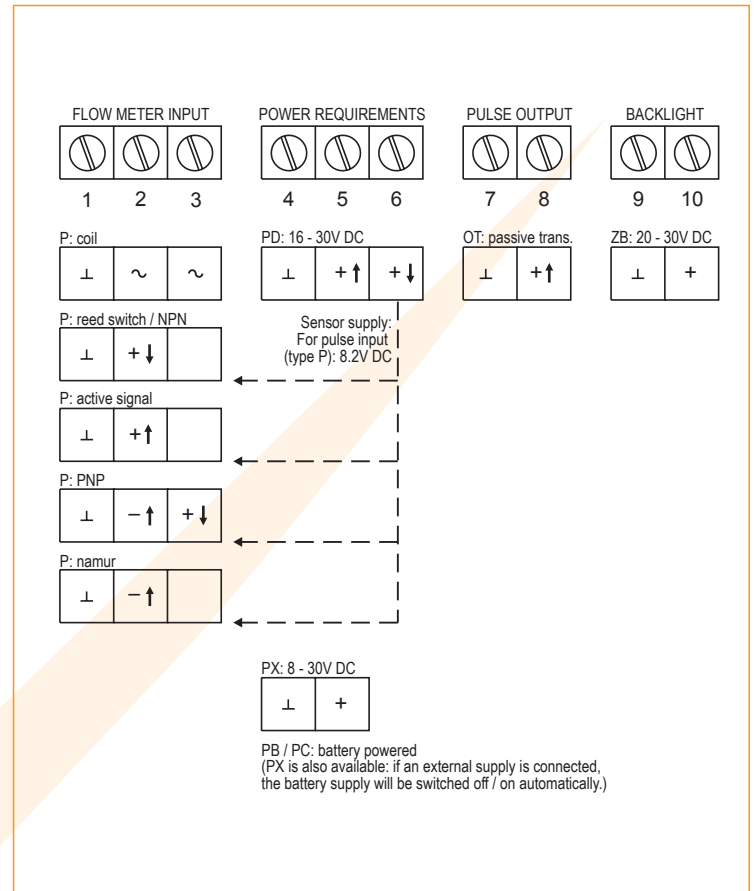

Terminal connections PF - PM

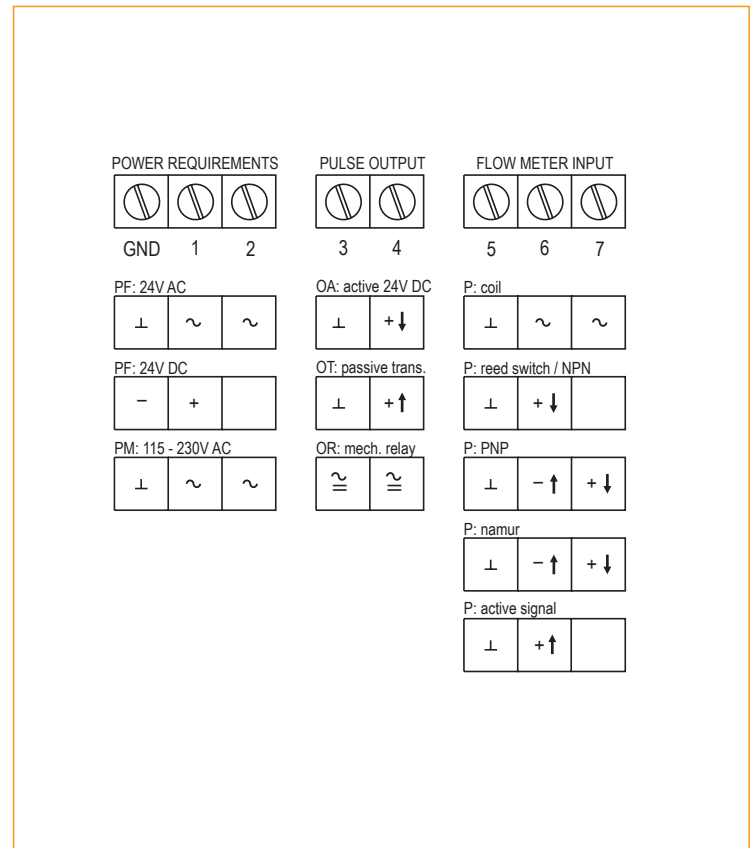

Typical wiring diagram Fo16-P-(OT)-PB-(PX)-(ZB)

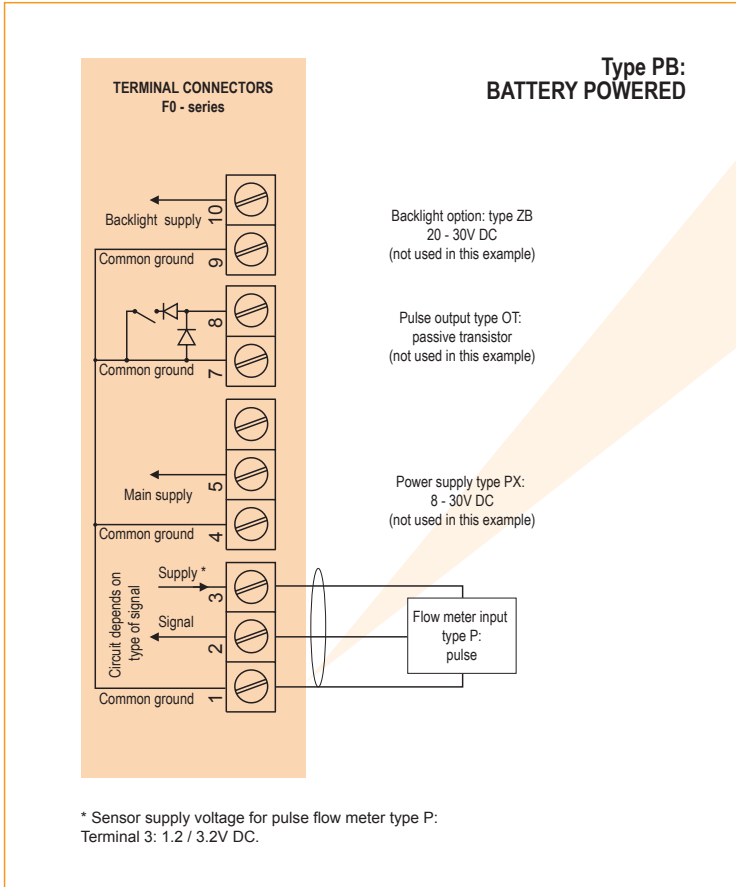

Typical wiring diagram Fo16-P-OT-PD-ZB

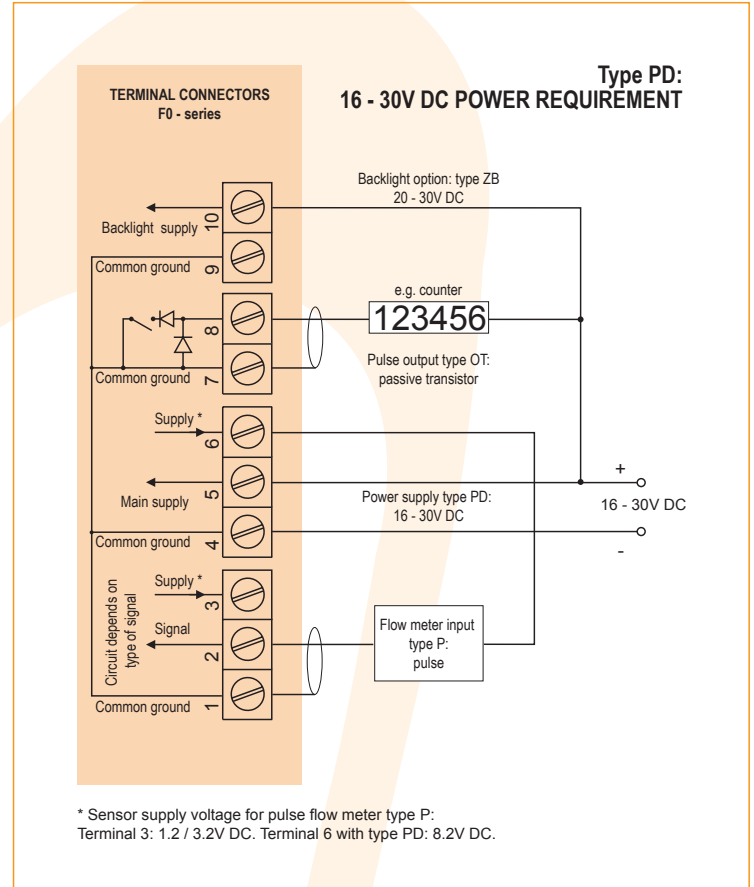

Typical wiring diagram Fo16-P-OA-PF-ZB

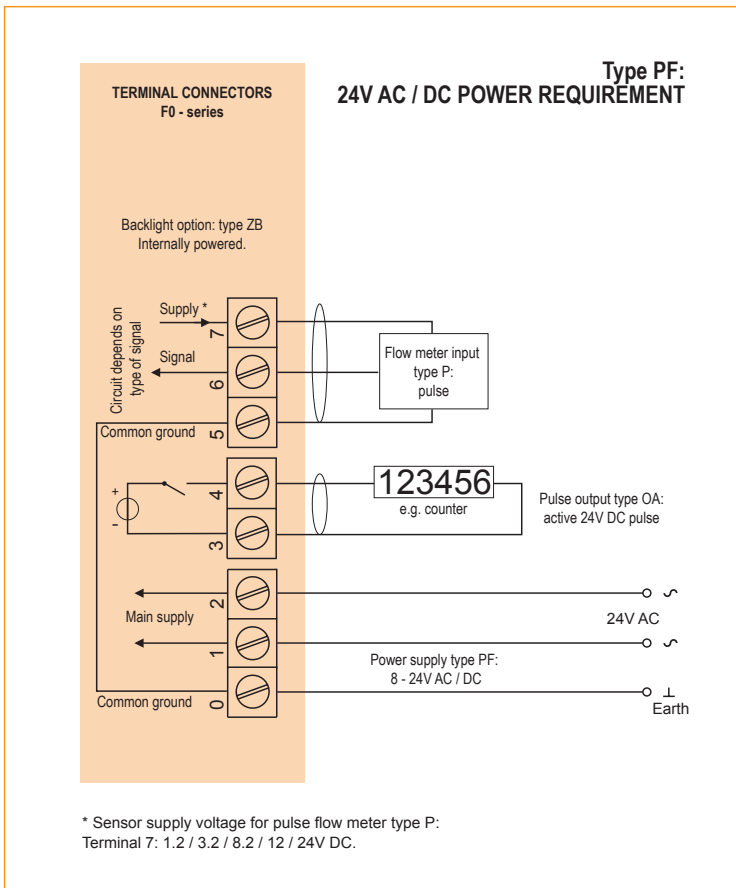

Typical wiring diagram Fo16-P-OR-PM-ZB

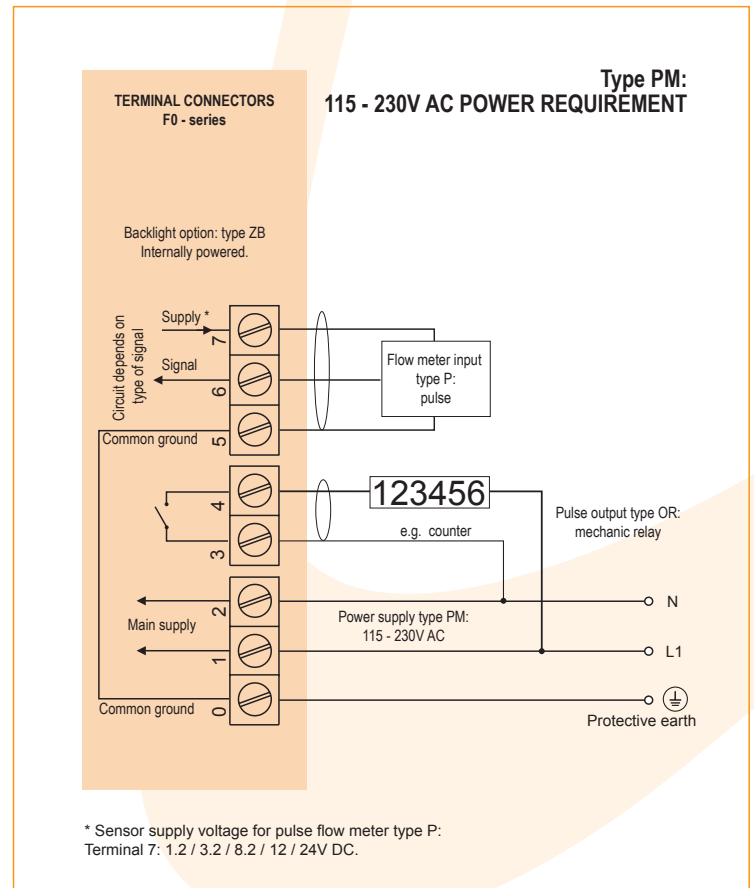

Hazardous area applications

The Fo16-XI has been certified according ATEX and IECEx by KEMA and according CSA c-us and FM for use in Intrinsically Safe applications with an ambient temperature of -40°C to +70°C (-40°F to +158°F).

- The ATEX markings for gas and dust applications are:

II 1 G Ex ia IIC T4
II 1 D Ex iaD 20 IP 65/67 T 100 °C.

- The IECEx markings for gas and dust applications are: **Ga Ex ia IIC T4** and **Ex iaD 20 IP 65/67 T100 °C.**
- The CSA c-us markings are: **Class I/II/III, Division 1, Groups A, B, C, D, E, F, G, Temperature class T4** and **Class I, Zone o, AEx ia IIC T4.**
- The FM markings are: **Class I/II/III, Division 1, Groups A, B, C, D, E, F, G, Temperature class T4** and **Class I, Zone o, AEx ia IIC T4.**

It is allowed to connect up to three I.S. power supplies to power the unit, sensor and back-light. Consult the certificate for the maximum input and output values of the circuits. The Fo16-PD-XI offers a 8.2V DC sensor supply to power e.g. a Namur sensor or the input voltage to power an analog sensor. An ATEX approved flame proof enclosure with rating **Ex II 2 GD EEx d IIB T5** is available as well. Please contact your supplier for further details.

Certificate of conformity KEMA 05ATEX1168 X
• IECEx KEM 08.0006X • CSA.08.2059461 X

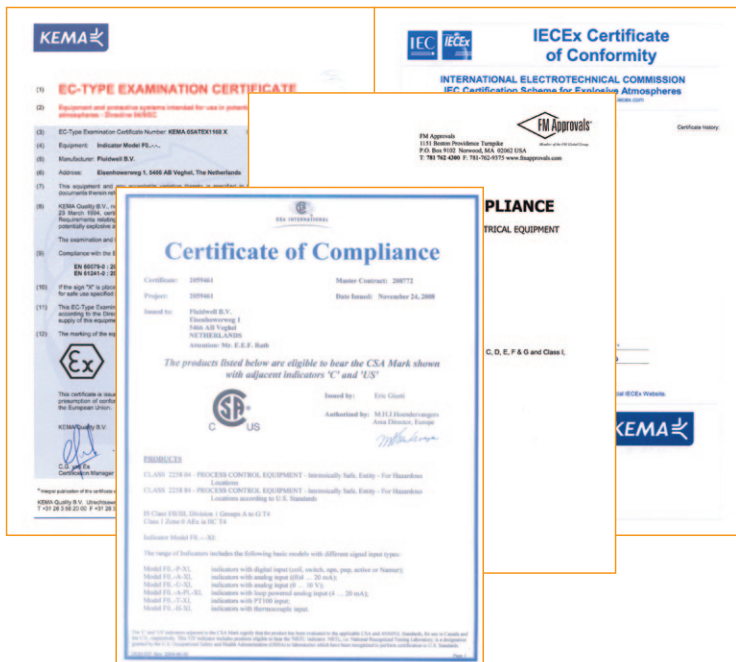

Configuration example IIA - IIB and IIC Fo16-P-(OT)-PC-(PX)-XI-(ZB) - Battery powered unit

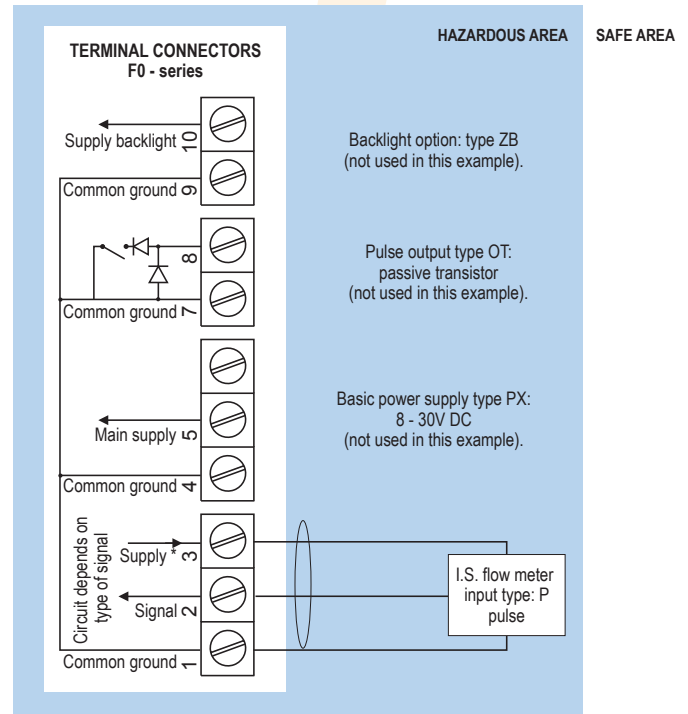

* Sensor supply voltage for pulse flow meter type P : Terminal 3: 1.2 / 3.2V DC.
Please note: type PX may be used in combination with the battery (type PC).
PX will power the unit; the battery will be disabled automatically till power is disconnected.

Configuration example IIA - IIB and IIC - Fo16-P-OT-PX-XI-ZB - Basic power requirement 8 - 30V DC

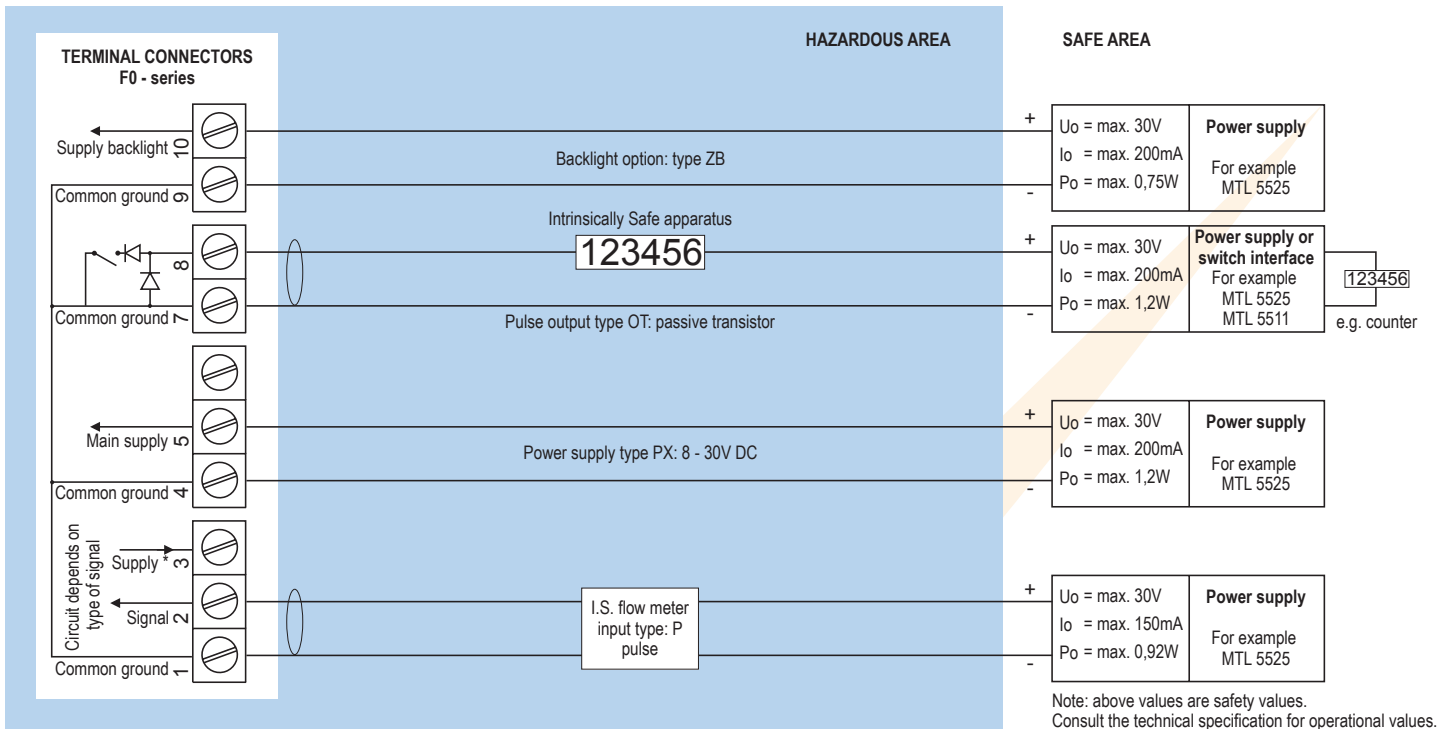

* Sensor supply voltage for pulse type P: Terminal 3: 1.2V / 3.2V DC.
Please note: type PX may be used in combination with the battery (type PC). PX will power the unit; the battery will be disabled automatically till power is disconnected.

Configuration example IIA - IIB and IIC - Fo16-P-OT-PD-XI-ZB - Power requirement 16 - 30V DC

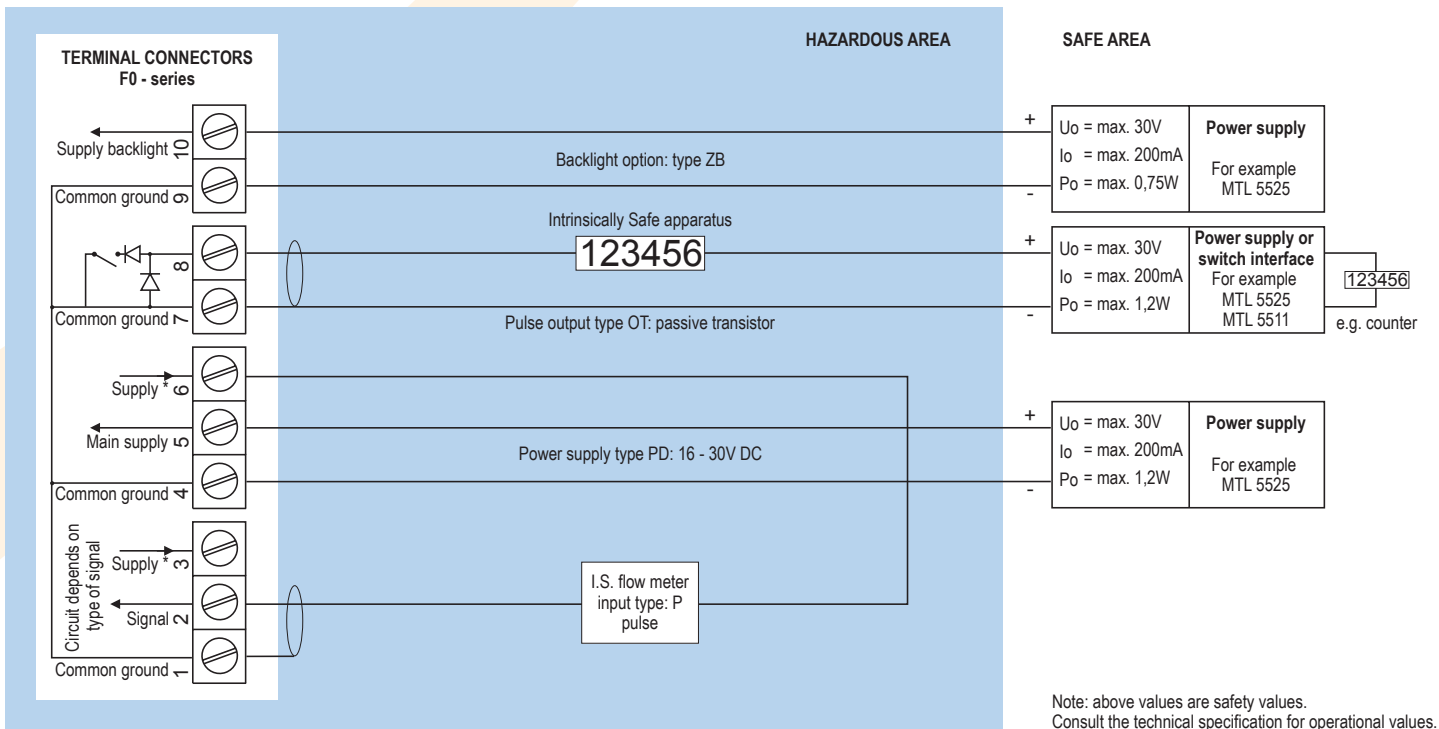

* Sensor supply voltage for pulse type P: Terminal 3: 1.2V / 3.2V DC. Terminal 6: 8.2V DC.
Please note: type PD may be used in combination with the battery (type PC). PD will power the unit; the battery will be disabled automatically till power is disconnected.

Technical specification

General

Display	
Type	High intensity reflective numeric and alphanumeric LCD, UV-resistant.
Dimensions	90 x 40mm (3.5" x 1.6").
Digits	Seven 17mm (0.67") and eleven 8mm (0.31") digits. Various symbols and measuring units.
Refresh rate	User definable: fast, 1sec, 3sec, 15sec, 30sec, off.
Option ZB	Transflective LCD with bi-color LED-backlight; green / amber. Intensity and color selected through the keyboard. Good readings in full sunlight and darkness. Also available Intrinsically Safe.

Ambient temperature

Safe areas	-40°C to +80°C (-40°F to +176°F).
Intrinsically Safe	-40°C to +70°C (-40°F to +158°F).

Power requirements

Type PB	Long life Lithium battery - life-time depends upon settings and configuration - up to 5 years.
Type PC	Intrinsically Safe long life lithium battery - life-time depends upon settings and configuration - up to 5 years.
Type PD	16 - 30V DC. Power consumption max. 1 Watt.
Type PF	24V AC / DC ± 10%. Power consumption max. 15 Watt.
Type PM	115 - 230V AC ± 10%. Power consumption max. 15 Watt.
Type PX	8 - 30V DC. Power consumption max. 0.3 Watt.
Type ZB	20 - 30V DC. Power consumption max. 1 Watt. With type PF / PM: internally powered.
Note PB/PF/PM	Not available Intrinsically Safe.
Note PF/PM	The total consumption of the sensor, active output type OA and backlight type ZB may not exceed 400mA @ 24V DC.
Note	For Intrinsically Safe applications, consult the safety values in the certificate.

Sensor excitation

Type PB/PC/PX	3.2V DC for pulse signals and 1.2V DC for coil pick-up.
Note	This is not a real sensor supply. Only suitable for sensors with a very low power consumption like coils (sine wave) and reed-switches.
Type PD	1.2 / 3.2 / 8.2V DC - max. 5mA@8.2V DC.
Type PF / PM	1.2 / 3.2 / 8.2 / 12 / 24V DC - max. 400mA @ 24V DC.

Terminal connections

Type	Removable plug-in terminal strip. Wire max. 1.5mm ² and 2.5mm ² .
------	--

Data protection

Type	EEPROM backup of all settings. Backup of running totals every minute. Data retention at least 10 years.
Password	Configuration settings can be password protected.

Directives & Standards

EMC	Directive 2004/108/EC, FCC 47 CFR part 15.
Low voltage	Directive 2006/95/EC.
ATEX / IECEx	Directive 94/9/EC, IEC 60079-0, IEC 60079-11, IEC 60079-26.
FM	FM Class No. 3600, FM Class No. 3610.
CSA	CSA 22.2 No. 157-92.
IP & NEMA	EN 60529 & NEMA 250.

Enclosure

General

Window	Polycarbonate window.
Sealing	Silicone.
Control keys	Three industrial micro-switch keys. UV-resistant silicone keypad.

Aluminum wall / field mount enclosures

General	Die-cast aluminum wall/field mount enclosure IP67 / NEMA 4X with 2-component UV-resistant coating.
Dimensions	130 x 120 x 75mm (5.12" x 4.72" x 2.95") - W x H x D.
Weight	1100 gr.
Type HA	Cable entry: 2 x PG9 and 1 x M20.
Type HL	Cable entry: 2 x 1/2" NPT.
Type HM	Cable entry: 2 x M16 and 1 x M20.
Type HN	Cable entry: 1 x M20.
Type HO	Cable entry: 2 x M20.
Type HP	Cable entry: 6 x M12.
Type HT	Cable entry: 1 x 1/2" NPT.
Type HU	Cable entry: 3 x 1/2" NPT.
Type HV	Cable entry: 4 x M20.
Type HZ	Cable entry: no holes.

GRP wall / field mount enclosures

General	GRP wall/field mount enclosure IP67 / NEMA 4X, UV-resistant and flame retardant.
Dimensions	130 x 120 x 75mm (5.12" x 4.72" x 2.95") - W x H x D.
Weight	600 gr.
Type HD	Cable entry: no holes.
Type HE	Cable entry: 2 x Ø 16mm and 1 x Ø 20mm.
Type HF	Cable entry: 1 x Ø 22mm (7/8").
Type HG	Cable entry: 2 x Ø 20mm.
Type HH	Cable entry: 6 x Ø 12mm.
Type HJ	Cable entry: 3 x Ø 22mm (7/8").
Type HK	Flat bottom, cable entry: no holes.

Panel mount enclosures

Dimensions	130 x 120 x 60mm (5.12" x 4.72" x 2.36") - W x H x D.
Panel cut-out	115 x 98mm (4.53" x 3.86") L x H.
Type HB	Die-cast aluminum panel mount enclosure IP65 / NEMA 4X.
Weight	600 gr.
Type HC	GRP panel mount enclosure IP65 / NEMA 4X, UV-resistant and flame retardant.
Weight	450 gr.

Hazardous area

Explosion proof

ATEX certification	II 2 GD EEx d IIB T5.
Type XF	Dimensions of enclosure: 300 x 250 x 200mm (11.8" x 9.9" x 7.9") L x H x D.
Weight	Appr. 15kg.

Intrinsically Safe

ATEX certification	II 1 G Ex ia IIC T4. II 1 D Ex iaD 20 IP 65 / 67 T 100 °C.
IECEX certification	Ga Ex ia IIC T4. Ex iaD 20 IP 65 / 67 T 100 °C.
CSA c-us certification	Intrinsically Safe for Class I/II/III, Div. 1, Groups A, B, C, D, E, F, G, Temp. class T4 and Class I, Zone o, AEx ia IIC T4.
FM certification	Intrinsically Safe for Class I/II/III, Div. 1, Groups A, B, C, D, E, F, G, Temp. class T4 and Class I, Zone o, AEx ia IIC T4.
Ambient Ta	-40°C to +70°C (-40°F to +158°F).

Signal input

Flow meter sensor

Type P	Coil / sine wave (HI: 20mVpp or LO: 80mVpp - sensitivity selectable), NPN/PNP, open collector, reed-switch, Namur, active pulse signals 8 - 12 and 24V DC.
Frequency	Minimum 0Hz - maximum 7kHz for total and flow rate. Maximum frequency depends on signal type and internal low-pass filter. E.g. reed switch with low-pass filter: max. frequency 120Hz.
K-Factor	0.000010 - 9,999,999 with variable decimal position.
Low-pass filter	Available for all pulse signals.
Option ZF	coil sensitivity 10mVpp.
Option ZG	coil sensitivity 5mVpp.

Signal output

Digital output

Function	Pulse output - transmitting accumulated total.
Frequency	Max. 500Hz. Pulse length user definable between 1msec up to 10 seconds.
Type OA	One active 24V DC transistor output (PNP); load max. 400mA (requires PF or PM).
Type OR	One electro-mechanical relay output - isolated; max. switch power 230V AC (N.O.) - 0.5A (requires PF or PM).
Type OT	One passive transistor output (NPN) - not isolated. Max. 50V DC - 300mA per output.

Display example - 90 x 40mm (3.5" x 1.6")

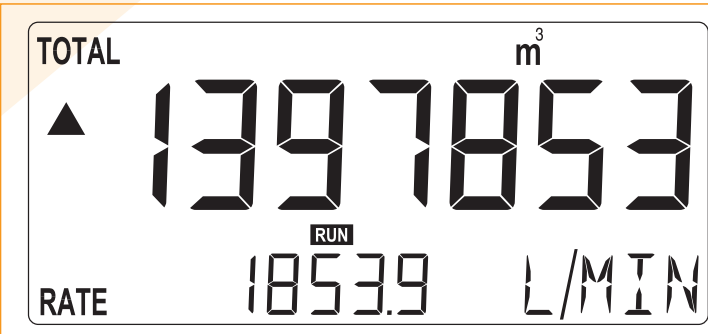

Operational

Operator functions

Displayed functions	<ul style="list-style-type: none"> Linearized flow rate and / or total. Linearized total and accumulated total. Total can be reset to zero by pressing the CLEAR-key twice.
---------------------	--

Total

Digits	7 digits.
Units	L, m³, GAL, USGAL, kg, lb, bbl, no unit.
Decimals	0 - 1 - 2 or 3.
Note	Total can be reset to zero.

Accumulated total

Digits	11 digits.
Units / decimals	According to selection for total.
Note	Can not be reset to zero.

Flow rate

Digits	7 digits.
Units	mL, L, m³, Gallons, kg, Ton, lb, bl, cf, RND, ft³, scf, Nm³, NL, igital - no units.
Decimals	0 - 1 - 2 or 3.
Time units	/sec - /min - /hr - /day.

Accessories

Mounting accessories





























ACFo2	Stainless steel wall mounting kit.
ACFo5	Stainless steel pipe mounting kit (worm gear clamps not included).
ACFo6	Two stainless steel worm gear clamps Ø 44 - 56mm.
ACFo7	Two stainless steel worm gear clamps Ø 58 - 75mm.
ACFo8	Two stainless steel worm gear clamps Ø 77 - 95mm.
ACFo9	Two stainless steel worm gear clamps Ø 106 - 138mm.
ACFo10	Customized Grevopal tagplates for ACFo2 and ACFo5, including stainless steel screws. Dimension: 95mm x 12.5mm (3.75" x 0.50").

Intrinsically Safe isolators

ACGo1	MTL5511 - One channel pulse or switch output transfer from hazardous area to safe area.
ACGo2	MTL5525 - One channel power supply from safe area to hazardous area (e.g. to power the unit with PD or to power a switching or analog device in hazardous area).
ACGo3	MTL5541 - One channel 4 - 20mA repeater from hazardous area to safe area.
ACGo4	MTL 5051 - Bi-direction serial-data-isolator (for Modbus communication).
ACGo5	MTL5516C - Two channel pulse or switch output transfer from hazardous area to safe area.
ACGo6	MTL5513 - One channel pulse or switch output transfer from hazardous area to safe area.
ACGo7	MTL5546Y - One channel isolated driver bringing 4 - 20mA from safe area to hazardous area, HART transparent, OCD.

Ordering information

Standard configuration: F016-P-HC-OT-PX-XX-ZX.

ordering information:	F016	-	-H	-O	-P	-X	-Z
Flow meter input signal							
P 	Pulse input: coil, npn, pnp, namur, reed-switch.						
Panel mount enclosures - IP65 / NEMA4X							
HB 	Aluminum enclosure.						
HC 	GRP enclosure.						
GRP field / wall mount enclosures - IP67 / NEMA4X							
HD 	Cable entry: no holes.						
HE 	Cable entry: 2 x Ø 16mm & 1 x Ø 20mm.						
HF 	Cable entry: 1 x Ø 22mm (7/8").						
HG 	Cable entry: 2 x Ø 20mm.						
HH 	Cable entry: 6 x Ø 12mm.						
HJ 	Cable entry: 3 x Ø 22mm (7/8").						
HK 	Flat bottom, cable entry: no holes.						
Aluminum field / wall mount enclosures - IP67 / NEMA4X							
HA 	Cable entry: 2 x PG9 + 1 x M20.						
HL 	Cable entry: 2 x 1/2" NPT.						
HM 	Cable entry: 2 x M16 + 1 x M20.						
HN 	Cable entry: 1 x M20.						
HO 	Cable entry: 2 x M20.						
HP 	Cable entry: 6 x M12.						
HT 	Cable entry: 1 x 1/2" NPT.						
HU 	Cable entry: 3 x 1/2" NPT.						
HV 	Cable entry: 4 x M20.						
HZ 	Cable entry: no holes.						
Digital output signal							
OA	One active transistor output - requires PF or PM.						
OR	One mechanical relay output - requires PF or PM.						
OT 	One passive transistor output - standard configuration.						
Power requirements							
PB	Lithium battery powered.						
PC 	Lithium battery powered - Intrinsically Safe.						
PD 	16 - 30V DC + sensor supply.						
PF	24V AC / DC + sensor supply.						
PM	115 - 230V AC + sensor supply.						
PX 	Basic power supply 8 - 30V DC (no real sensor supply).						
Hazardous area							
XI 	Intrinsically Safe, according ATEX, IECEx, CSA c-us and FM.						
XF	EExd enclosure - 3 keys.						
XX	Safe area only.						
Other options							
ZB 	Backlight.						
ZF 	Coil input 10mVpp.						
ZG 	Coil input 5mVpp.						
ZX 	No options.						

The bold marked text contains the standard configuration.

 Available Intrinsically Safe.

Specifications are subject to change without notice.



Fluidwell bv
 P.O. Box 6
 5460 AA - Veghel - The Netherlands
 Telephone: +31 (0)413 343 786
 Telefax: +31 (0)413 363 443
 email: displays@fluidwell.com
 Internet: www.fluidwell.com

