

FCI ST75 Series Flow Meters

Small Line, Mass Flow Meters for Industrial and Commercial Process Gases

Low cost, easy installation flow measuring
for 1/4 inch to 2 inch [6 mm to 51 mm] line sizes

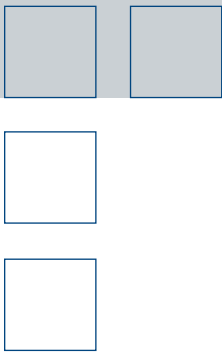
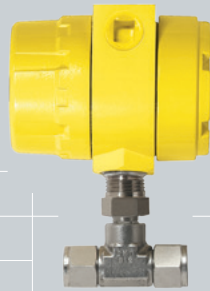
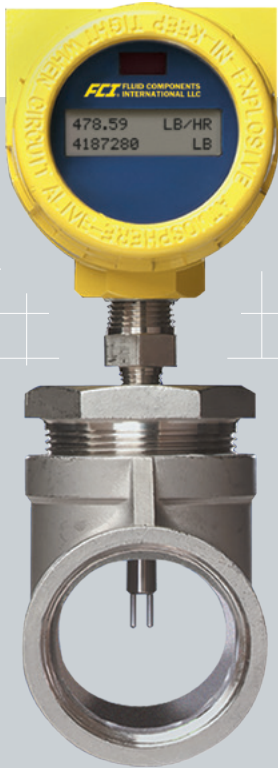

- Burner/Boiler Fuel and Air Feed Lines
- Industrial Furnaces, Kilns and Oven Fuel/Air Controls
- Heat Treating Gas Controls
- Air Compressor System Control and Point-of-Use Monitoring
- Chiller Air Flow Measurements
- Co-Gen and Turbine Generator Fuel Flow Measurements
- Dosing and Gas Injection Rate Controls

ST75 Series Features

- Direct mass, standard volumetric or standard velocity flow measurement
- Triple outputs: flow rate, temperature and total flow
- HART I/O (ST75A, ST75AV)
- Non-clogging, no moving parts
- 2 line digital display option
- Small, compact design
- Easy installation
- Built-in Vortab® flow conditioning (ST75V, ST75AV)
- SIL compliant

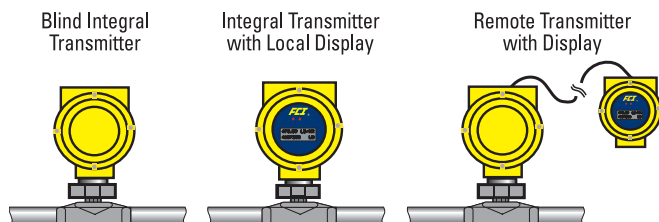

Figure 1: ST75 Series standard configurations

* For pipes larger than 2 inches [51 mm] see FCI insertion style flow meters.

Superior Air and Gas Flow Measurement

ST75 is an accurate, no moving parts, direct mass flow measurement and monitoring solution for fuel gases, air, compressed air, inert and other gas flows within industrial processes. There are four base models in the series: ST75, ST75A, ST75V, and ST75AV. The "A" suffix models provide enhanced features and HART I/O (see chart below); the "V" suffix models include built-in Vortab flow conditioners. They are available in six different sizes for direct, in-line installation in line sizes from 1/4 inch to 2 inch [6 mm to 51 mm].*

Model	ST75	ST75 A	ST75 V	ST75 AV
Vortab flow conditioning			■	■
Dual 4-20 mA outputs	■	■	■	■
4-20 mA per NAMUR NE43		■		■
HART I/O		■		■
500 Hz pulse output	■	■	■	■
Maximum remote distance	50' [15 m]	100' [30 m]	50' [15 m]	100' [30 m]
SIL compliance rating		■		■
Warranty <i>Standard</i>	1 year	2 years	1 year	2 years

By combining precision lithography structured platinum RTD sensors embedded in FCI's equal mass thermowells with microprocessor electronics and precise actual gas calibration, the ST75 achieves outstanding flow measurement performance. Using FCI's proven thermal dispersion technology, the ST75's direct mass flow measurement eliminates the cost and space of additional sensors required by inferred technologies. With its 100:1 turndown and flow ranges from 0.01 SCFM to 559 SCFM [0,01 NCMH to 950 NCMH], the ST75 measures over a wide flow range, from low to high flow conditions. The ST75 is available in specific calibrations for most gases including natural gas, methane and other hydrocarbon gases, as well as nitrogen, CO₂, argon and all inert gases, compressed air and more.

Easy to Install, Easy to Use

Models ST75 and ST75A have a standard "T" fitting design that allows for fast, simple in-line installation. Standard NPT line size selections include 1/4 inch, 1/2 inch, 3/4 inch, 1 inch, 1-1/2 inch and 2 inch. For compression fitting tube applications, selections include 1/4 inch, 1/2 inch and 1 inch. For installations with inadequate straight-run or obstructed flows that prevent a fully developed profile for accurate flow measurement with the standard ST75, Models ST75V and ST75AV provide the solution. FCI's ST75V and ST75AV include all of the features and functionality of the ST75 plus built-in Vortab flow conditioning.

Vortab flow conditioners are the flow conditioning technology proven and recommended by flow measurement experts to eliminate both swirl and velocity profile distortions to ensure accurate flow measurement. Vortab flow conditioners also are the lowest pressure loss solution of all flow conditioning techniques. FCI is the exclusive

provider of Vortab flow conditioners for use with thermal mass flow meters such as the ST75V and ST75AV.

To serve a variety of application and installation requirements, the ST75 Series is available in three standard configurations (see Figure 1 on page 2).

To provide convenient and easy access for wire-up and signal isolation, the instrument's enclosure features dual conduit ports in either NPT or M20 threads, as well as removable front and rear covers. ST75 models can be ordered for DC (18V to 36V) or AC (85V to 265V) power.

Extensive Outputs Assure Application Compatibility

ST75 provides the most comprehensive selection of outputs in its class. Dual analog outputs, a pulse output and a digital, serial I/O are standard on all models. Models ST75A and ST75AV include HART.

Dual 4-20 mA analog outputs are field assignable to flow rate and/or temperature. These outputs are user scalable to the instrument's full calibrated range or any subset. Flow rate is selectable for reading in mass flow or standard volumetric engineering units. A 0-500 Hz pulse output of flow is provided for interface to totalizers

A two-way HART bus over the #1 4-20 mA output is provided with Models ST75A and ST75AV. The HART bus complies with revision level 7 protocol, is fully compatible with all versions of HART field communicators and control systems, and has been certified by the FieldComm organization.

In all models a standard RS232C serial I/O link is provided for instrument configuration, service/troubleshooting data, and measured readings.

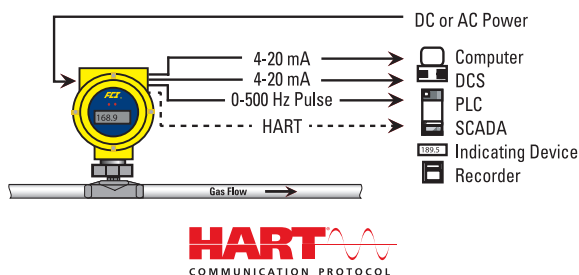

Designed and Built to Last

ST75 will significantly reduce maintenance costs and time. ST75 is a no moving parts design that virtually eliminates the wear out, clogging and excessive pressure drop associated with other flow metering techniques. The sensor element is all-welded stainless steel with Hastelloy-C tips that provide extra protection against invasive conditions within the pipe. The instrument's electronics are housed in an all-metal, aluminum, or stainless steel NEMA 4X (IP67) rated enclosure to provide the ruggedness and dust/weather proof protection needed to ensure long-life in industrial and commercial installations.

Find your gas here?

FCI has provided thermal mass flow meter solutions for all of these and more . . .

Acetaldehyde	Ethyl Acrylate	Ketene	Phenol
Acetic Acid	Ethyl Alcohol	Krypton	Phosgene
Acetone	Ethyl Amine	Landfill Gas	Propadiene
Acetonitrile	Ethyl Benzene	M-Cresol	Propane
Acetyl Chloride	Ethyl Bromide	Mercury	Propanol
Air	Ethyl Chloride	Methane	Propyl Chloride
Allyl Chloride	Ethyl Fluoride	Methanol	Propylene
Ammonia	Ethyl Mercaptan	Methyl Acetate	Propylene Oxide
Aniline	Ethylene	Methyl Alcohol	Propyne
Argon	Ethylene Dichloride	Methyl Amine	P-Xylene
Benzene	Ethylene Oxide	Methyl Butane	R-11
Bio-Gas	Flare Gas	Methyl Fluoride	R-12
Boron Trifluoride	Fluorine	Methyl Formate	R-13
Bromine	Fluorobenzene	Methyl Hexane	R-13B1
Bromobenzene	Fluoroform	Methyl Hydrazine	R-14
Butadiene	Freon-11	Methyl	R-21
Butene	Freon-12	Mercaptan	R-22
Butylene Oxide	Freon-13	Methyl Octane	R-23
Butyne	Freon-14	Methyl Pentane	R-112
Carbon Dioxide	Freon-21	Methylal	R-113
Carbon Disulfide	Freon-22	Methylene Chloride	R-114
Carbon Monoxide	Freon-23	Morpholine	R-114B2
Carbon Tetrachloride	Furan	M-Xylene	R-115
Carbonyl Sulfide	Halon	Naphthalene	R-116
Chlorine	Helium	Natural Gas	R-134A
Chlorobenzene	Heptene	N-Butane	R-142B
Chloroethane	Hexanol	N-Butane	R-152A
Chloroform	Hexene	N-Butane	R-216
Chloromethane	Hydrazine	N-Butanol	R-500
Chloroprene	Hydrogen	N-Butyl Alcohol	R-502
Cis-2-Butene	Hydrogen Bromide	N-Decane	R-503
Cis-2-Hexene	Hydrogen Chloride	N-Dodecane	R-504
Compressed Air	Hydrogen Chloride	Neon	R-C318
Cumene	Hydrogen Cyanide	Neopentane	Radon
Cyanogen	Hydrogen Deuteride	N-Heptane	Silane
Cyclobutane	Hydrogen Fluoride	N-Hexane	Silicon Tetrachloride
Cyclohexane	Hydrogen Iodide	Nitric Oxide	Styrene
Cyclooctane	Hydrogen Peroxide	Nitrogen	Sulfur Dioxide
Cyclopentane	Hydrogen Sulfide	Nitrogen Dioxide	Sulfur Hexafluoride
Cyclopropane	Iodine	Nitromethane	Sulfur Trioxide
Decene	Isobutane	Nitrous Oxide	Superheated Thiophene
Deuterium	Isobutene	N-Nonane	Titanium Tetrachloride
Deuterium Oxide	Isobutyl Alcohol	N-Octane	Toluene
Diethyl Amine	Isoheptane	Nonene	Trans-2-Butene
Diethyl Ether	Isohexane	N-Pentane	Trimethyl Amine
Diethyl Ketone	Isooctane	N-Propanol	Triptane
Digester Gas	Isopentane	N-Propyl Alcohol	Uranium Hexafluoride
Dimethyl Ether	Isoprene	N-Propyl Amine	Vinyl Acetate
Dimethyl Propane	Isopropyl Alcohol	N-Undecane	Vinyl Chloride
Dimethyl Sulfide	Iodine	Octene	Vinyl Fluoride
Ethane	Isobutane	Oxygen	Vinyl Formate
Ethanol	Isobutene	O-Xylene	
Ethyl Acetate	Isopropyl Amine	Ozone	
		Pentanol	
		Pentene	

ST75 Series Flow Meter Specifications

Instrument

- **Media:** Air, compressed air, nitrogen, oxygen, argon, CO₂, ozone, other inert gases, natural gas, other hydrocarbon gases, and hydrogen

- **Pipe/Line Size Compatibility:** 1/4" to 2" [6 mm to 51 mm]¹

- **Range²**

NPT Line Size	Minimum SCFM	Minimum [NCMH]	Maximum SCFM	Maximum [NCMH]
1/4"	0.04	[0,07]	17.34	[29,47]
1/2"	0.13	[0,22]	50.64	[86,04]
3/4"	0.22	[0,38]	88.88	[151,00]
1"	0.35	[0,59]	139.95	[237,78]
1-1/2"	0.85	[1,44]	339.31	[576,48]
2"	1.40	[2,38]	559.27	[950,20]

Tubing Line Size	Minimum SCFM	Minimum [NCMH]	Maximum SCFM	Maximum [NCMH]
1/4"	0.01	[0,01]	3.02	[5,14]
1/2"	0.05	[0,09]	21.15	[35,94]
3/4"	0.25	[0,42]	99.08	[168,33]

- **Accuracy**

Model ST75, ST75 A

Standard: ±2% reading, ±0.5% full scale
Optional: ±1% reading, ±0.5% full scale

Model ST75V, ST75 AV

Standard: ±1% reading, ±0.5% full scale

- **Repeatability:** ±0.5% reading

- **Turndown Ratio:** 3:1 to 100:1

- **Temperature Compensation**

Standard: 40 °F to 100 °F [4 °C to 38 °C]
Optional: 0 °F to 250 °F [-18 °C to 121 °C]

- **Agency Approvals**

FM, FMC: Class I, Division 1, Groups B, C, D; T4 Ta= 60°C
Class II/III, Division 1, Groups E, F, G; T4 Ta= 60°C;
Type 4X, IP66
ATEX, IECEx: Class I, Division 2, Groups A, B, C, D; T4 Ta= 60°C
Zone 1, Zone 21
II 2 G Ex db IIC T6...T1 Gb
II 2 D Ex tb IIIC T85°C...T300°C Db; IP66/IP67
Ta= -40°C to +65°C

Other:

ST75, ST75V: EAC (TRCU) Russia, CE marking, CPA, PED, CRN
ST75 A, ST75 AV: EAC (TRCU) Russia (*pending*), CE marking, PED, CRN

SIL: SIL 1 compliant, safe failure fraction (SFF)
78.5% to 81.1%

- **Warranty**

ST75, ST75V: One year
ST75 A, ST75 AV: Two years

Flow Element

- **Installation:** In-line "T," NPT or tube

- **Type:** Thermal dispersion

- **Material of Construction**

All-welded 316 stainless steel probe element with Hastelloy-C thermowells; 316 stainless steel NPT and tube fittings; ST75 V and ST75 AV flow body is schedule 40 stainless steel

- **Maximum Operating Pressure**

T-fitting [NPT female]: 240 psi [16.5 barg]
Tube: 600 psi [41 barg]

- **Operating Temperature (Process)**

0 °F to 250 °F [-18 °C to 121 °C]

- **Process Connection**

Model ST75, ST75 A

T-fitting [NPT female]: 1/4", 1/2", 3/4", 1", 1 1/2" or 2"
Tubing: 1/4", 1/2" or 1"

Model ST75 V, ST75 AV

Female NPT, Male NPT, ANSI flanges, DIN flanges

Transmitter

- **Enclosure**

Rating: NEMA 4X, IP67

Material

Standard: Aluminum, polyester powder coated

Optional: 316 stainless steel

Conduit/Cable Port: Dual, 1/2" NPT or M20x1.5

- **Operating Temperature**

0 °F to 140 °F [-18 °C to 60 °C]

- **Input Power**

DC: 18 Vdc to 36 Vdc (6 watt maximum)

AC: 85 Vac to 265 Vac (12 watt maximum)

(CE mark approval from 100 Vac to 240 Vac)

- **Output Signal**

Standard

(2) 4-20 mA, user assignable to flow rate and/or temperature

(1) 0-500 Hz pulse for total flow

ST75 A and ST75 AV output #1 have fault indication per NAMUR NE43 guidelines; user selectable for high (>21.0 mA) or low (<3.6 mA)

- **Bus Communications**

ST75 A, ST75 AV: HART (Version 7); FieldComm Group certified

Available over output #1; DD file included

- **Communication Port:** RS232C standard

- **Digital Display (optional):** 2-line x 16 characters LCD. Displays measured

value and engineering units. Top line assigned to flow rate. Second line is

user assignable to temperature reading, as flow totalizer or alternating.

Display can be rotated in 90° increments for optimum viewing orientation.

¹ For line sizes > 2 inches [> 51 mm] see FCI insertion-style flow meters

² Actual range subject to gas type and specific conditions

Specifications at reference operating conditions of 70 °F, 14.7 psia [21.1 °C, 1.013 bar(a)] and for Models ST75, ST75 A straight pipe run 20d upstream, 10d downstream.

FCI is a continuous improvement company. Specifications subject to change without notice.

ST75 Series Features

In-line, Mass Flow Measurement

With premium components and attention to detail, FCI's ST75 series provides long-lasting flow meter quality and value. Its features and functions ensure application compatibility, maximum installation convenience, superior industrial durability and lowest maintenance.

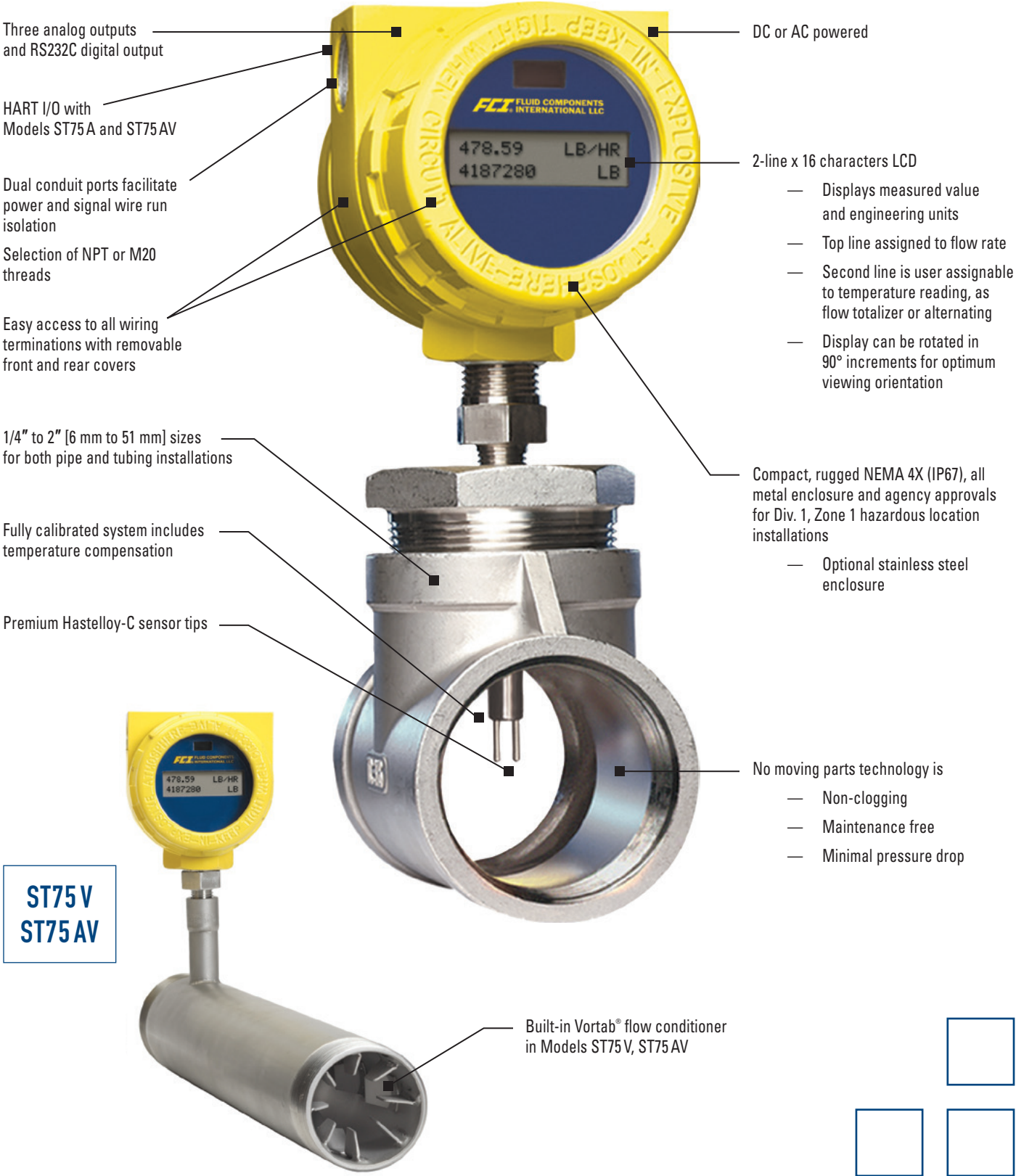

Models ST75/ST75A Pipe (NPT) Tee Configuration

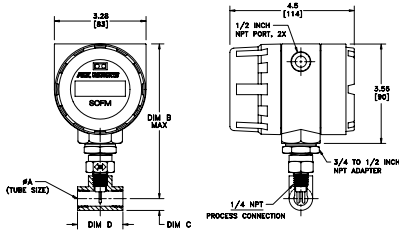

1. DIMENSIONS IN INCHES; BRACKETS [] ARE IN mm.
2. REDUCERS USED ON LARGER PIPE TEES (NOT SHOWN) ALLOW FOR MAX B DIMENSION.
3. PIPE TEES ARE 150 # CLASS.

Pipe (NPT) Tee Configuration			
DIM A Pipe Size	DIM B Top to Flow CL	DIM C Flow CL to Bottom	DIM D Tee Length
1/4"	6.0 [152,4] Max.	0.38 [9,65]	1.54 [39,12]
1/2"	6.5 [165,1] Max.	0.56 [14,22]	2.28 [57,91]
3/4"	7.0 [177,8] Max.	0.68 [17,27]	2.56 [65,02]
1"	7.3 [185,4] Max.	0.86 [21,84]	2.92 [74,17]
1 1/2"	7.8 [198,1] Max.	1.17 [29,72]	3.82 [97,03]
2"	8.0 [203,2] Max.	1.42 [36,07]	4.66 [118,40]

Models ST75/ST75A Tube Tee Configuration

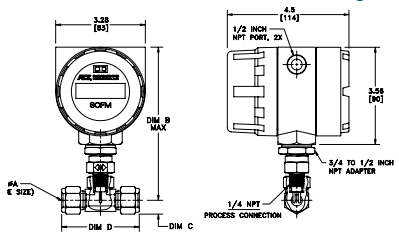

1. DIMENSIONS IN INCHES; BRACKETS [] ARE IN mm.
2. COMPRESSION FITTING FERRULES 316 SST.

Tube Tee Configuration			
DIM A Pipe Size	DIM B Top to Flow CL	DIM C Flow CL to Bottom	DIM D Tee Length
1/4"	5.7 [144,8] Max.	0.33 [8,39]	2.34 [59,44]
1/2"	5.9 [149,9] Max.	0.53 [13,46]	2.84 [72,14]
3/4"	7.8 [198,1] Max.	0.87 [22,10]	3.86 [98,04]

Models ST75V/ST75AV Female NPT

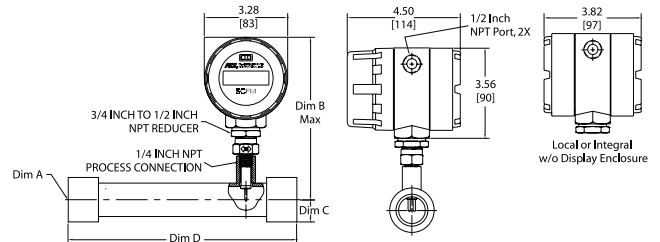

1. Dimensions are in INCHES; brackets [] are in MILLIMETERS.

Female NPT Configuration			
DIM A Pipe Size	DIM B Top to Flow CL	DIM C Flow CL to Bottom	DIM D VMR Length
1/4"	5.50 [140]	0.38 [9,5]	5.00 [127]
1/2"	5.69 [144,5]	0.57 [14]	7.50 [190,5]
3/4"	6.45 [164]	0.69 [17,5]	9.00 [229]
1"	6.44 [163,5]	0.88 [22]	9.00 [229]
1 1/2"	6.42 [163]	1.25 [32]	13.50 [343]
2"	6.43 [163]	1.50 [38]	18.00 [457]

Models ST75V/ST75AV Male NPT

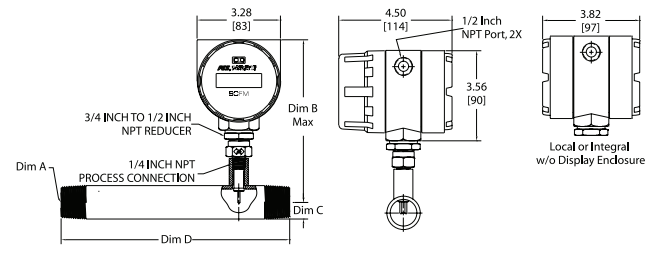

1. Dimensions are in INCHES; brackets [] are in MILLIMETERS.

Male NPT Configuration			
DIM A Pipe Size	DIM B Top to Flow CL	DIM C Flow CL to Bottom	DIM D Tee Length
1/4"	5.50 [140]	0.38 [9,5]	5.00 [127]
1/2"	5.69 [144,5]	0.42 [10,6]	7.50 [190,5]
3/4"	6.45 [164]	0.51 [13]	9.00 [229]
1"	6.44 [163,5]	0.65 [16,5]	9.00 [229]
1 1/2"	6.42 [163]	.95 [24]	13.50 [343]
2"	6.43 [163]	1.19 [30]	18.00 [457]

Models ST75V/ST75AV Flanged

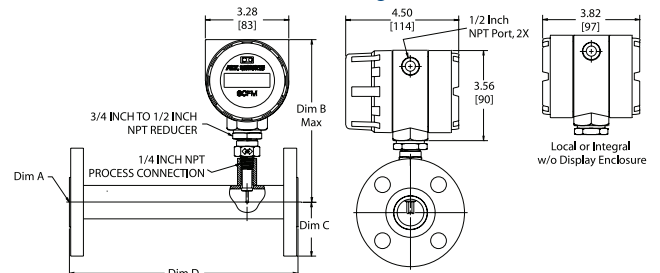

1. Dimensions are in INCHES; brackets [] are in MILLIMETERS.
2. Flanges are 150# Class.

Flanged Configuration			
DIM A Pipe Size	DIM B Top to Flow CL	DIM C Flow CL to Bottom	DIM D Tee Length
1/4"	n/a	n/a	n/a
1/2"	5.69 [144,5]	1.75 [45]	7.50 [190,5]
3/4"	6.45 [164]	1.94 [49]	9.00 [229]
1"	6.44 [163,5]	2.12 [54]	9.00 [229]
1 1/2"	6.42 [163]	2.50 [64]	13.50 [343]
2"	6.43 [163]	3.00 [76]	18.00 [457]

More Air / Gas Mass Flow Meter Solutions

In addition to the ST75 Series, FCI manufactures a broad line of thermal dispersion flow meter products for industrial and plant applications. From general-purpose air flow measurement to special-function, mixed gas flare flows; from small line sizes to the largest stacks and ducts, FCI has the selection to best solve your applications and ensure optimum solutions. Contact your local FCI representative or visit www.FluidComponents.com for detailed product information and specifications on these products.



- **ST50 Series** models are compact and economical, yet full featured air and gas meters designed for air, compressed air, nitrogen (ST50) and biogas, digester gas, natural gas (ST51, ST51 A) applications.



- **ST98 Series** for all gases, combines high-performance, extensive installation options and an array of output choices to meet the needs of the most demanding industrial applications.



- **ST100 Series** is industry's most advanced gas flow meters. All gases, flow, temperature and pressure, multiple outputs, bus communications, graphical display, multiple calibrations, VeriCal, on-board data logger, and more.



- **MT Series** "multi-point" flow measuring systems can be configured with two (2) to sixteen (16) flow sensing elements to optimize measurements within the largest of pipe and duct sizes.

FCI Calibration Ensures Installed Accuracy

The ST75 Series is tested and calibrated to rigorous standards to ensure you get the instrument that does the job you specified. To design and produce the highest quality flow instrumentation, FCI operates a world-class flow calibration laboratory with equipment traceable to NIST, ISO 17025, MIL-STD 45662A, and ANSI/NCSS Z-540.

For most gases, FCI thermal dispersion flow meters are calibrated using the actual gas as well as the actual temperature and process conditions matching your application. Other suppliers are limited to air calibration with un-validated theoretical equivalencies for gases. FCI has demonstrated this procedure to be inferior and subject to installed errors well outside published specifications. For most other suppliers to perform actual gas calibrations equal to FCI, their flow meter must be sent to an outside laboratory resulting in extra costs and shipping delays to you.

FCI's calibration results in a flow meter you can install with total confidence and assurance that it meets your application needs.

More than 19 precision flow stands to match NIST traceable fluids, process conditions, flow rates and line sizes specified in your application.



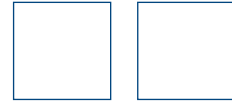
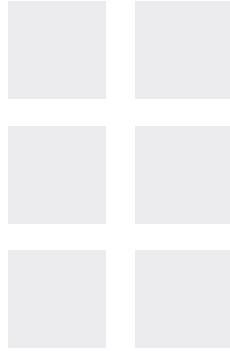

FCI FLUID COMPONENTS INTERNATIONAL LLC

Locally Represented By:

Visit FCI online at www.FluidComponents.com | FCI is ISO 9001:2000 and AS9100 Certified

FCI World Headquarters

1755 La Costa Meadows Drive | San Marcos, California 92078 USA
Phone: 760-744-6950 Toll Free (US): 800-854-1993 Fax: 760-736-6250

FCI Europe

Persephonestraat 3-01 | 5047 TT Tilburg, The Netherlands | Phone: 31-13-5159989 Fax: 31-13-5799036

FCI Measurement and Control Technology (Beijing) Co., LTD | www.fluidcomponents.cn

Room 107, Xianfeng Building II, No.7 Kaituo Road, Shangdi IT Industry Base, Haidian District | Beijing 100085, P. R. China
Phone: 86-10-82782381 Fax: 86-10-58851152

NOTICE OF PROPRIETARY RIGHTS

This document contains confidential technical data, including trade secrets and proprietary information, which is the property of Fluid Components International LLC (FCI). Disclosure of this data to you is expressly conditional upon your assent that its use is limited to use within your company only (and does not include manufacture or processing uses). Any other use is strictly prohibited without prior written consent of FCI.

REVISIONS		
REV	DESCRIPTION	DATE
B	ECN002416	6/24/15

INTEGRAL HORIZONTAL MOUNTINGS

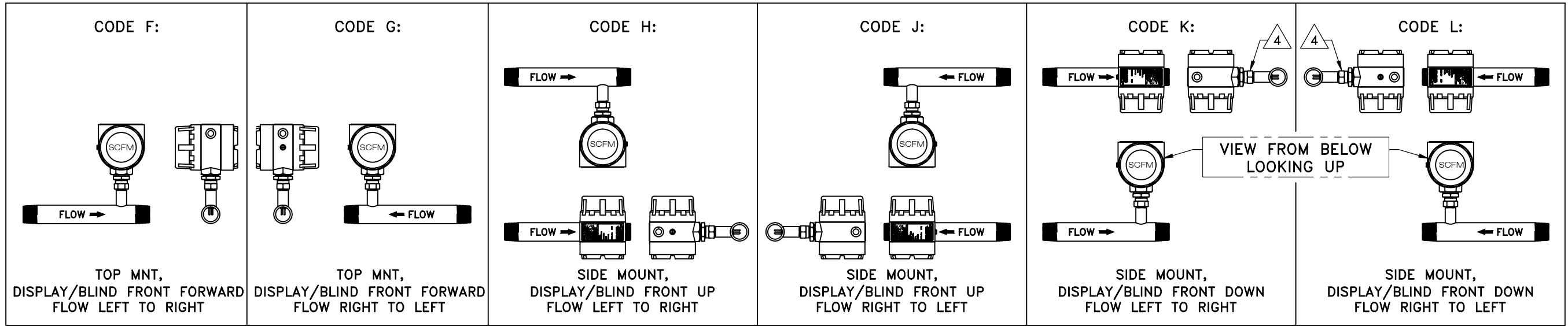

INTEGRAL VERTICAL MOUNTINGS

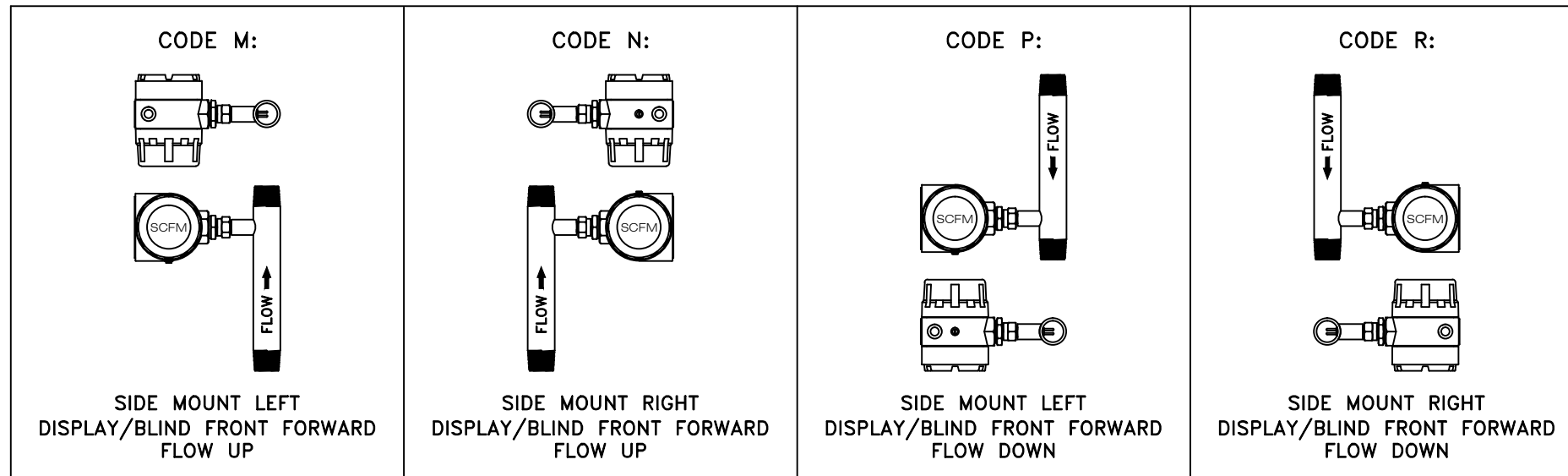

4 FLOW ARROW ON TOP AS SHOWN.

- 3. THE LCD DISPLAY CAN BE USER ROTATED AND VIEWED AT ANY 90 DEGREE ORIENTATION.
- 2. IN REMOTE ELECTRONIC CONFIGURATIONS, THE LOCAL ENCLOSURE WILL BE ORIENTED AS SHOWN WITH SOLID COVER ON BOTH SIDES. INTERCONNECTING TERMINALS LOCATED INSIDE.
- 1. THIS DRAWING IS GENERIC IN NATURE, FOR SPECIFIC MODEL TYPE, ORIENTATION, CUSTOMER PROCESS CONNECTION, ETC, REFER TO IO&M MANUAL.

NOTES: UNLESS OTHERWISE SPECIFIED

UNLESS OTHERWISE SPECIFIED DIMENSIONS ARE IN INCHES		APPROVALS		APPROVALS		FLUID COMPONENTS INTERNATIONAL LLC SAN MARCOS, CA 92078			
TOLERANCES DECIMALS ANGULAR .X ±.1 ±1/2 .XX ±.03 .XXX ±.010		PRODUCT CERT APVL N/A	DRAWN Ed Pasqual	06/24/2015				TITLE ST75/ST75V, ASSEMBLY ORIENTATION	
THIRD ANGLE PROJECTION		CONTRACT N/A	CHECK Sam Kresch	06/24/2015		SIZE D	CAGE CODE 64818		
MATERIAL		MFG ENGR N/A	ENGR Ed Pasqual	06/24/2015		SCALE NONE	SHEET 1 OF 1		
MACH SURFACE FINISH: 125 RMS MAX		MACH RAD: .030	MATL MGMT Nancy Peters	06/24/2015					
DO NOT SCALE DRAWING		QA Burt Tanaka	06/24/2015						
PARTS TO BE FREE OF BURRS & SHARP EDGES									

ST75V-

--	--	--	--	--	--	--	--	--	--

Block No. 1 2 3 4 5 6 7 8 9 10

INSTRUCTIONS: To order an **ST75V**, please fill in each numbered block above by selecting required codes from the corresponding categories below. Use of any "W" or "*" codes requires prior approval from FCI. For special data, documentation, test reports or required quality reports, refer to FCI's Engineering and Quality Assurance Order Information Sheets (OIS).

Code	[BLOCK 1] Base Unit, Enclosure Style
<i>Enclosures: All Aluminum, NEMA 4X/IP67 rated, epoxy coated</i>	
1	Blind, Integral Transmitter, with two 1/2" FNPT cable entries
2	Integral Transmitter with Local Digital Display, with two 1/2" FNPT cable entries
4	Remote Transmitter with two 1/2" FNPT cable entries and with Digital Display <i>(Specify cable length in Block 10)</i>
A	Blind, Integral Transmitter, with two M20x1.5 cable entries
B	Integral Transmitter with Local Digital Display, with two M20x1.5 cable entries
C	Remote Transmitter with two M20x1.5 cable entries and w/Digital Display <i>(Specify cable length in Block 10)</i>

Code [BLOCK 2] Pipe Installation, Display/Transmitter Mounting Orientation and Flow Direction

Code	Horizontal Pipe	Code	Vertical Pipe
F	Top mnt, display face frwd, flow L-R	M	Side mnt L, display face frwd, flow up
G	Top mnt, display face frwd, flow R-L	N	Side mnt R, display face frwd, flow up
H	Side mnt, display face up, flow L-R	P	Side mnt L, display face frwd, flow down
J	Side mnt, display face up, flow R-L	R	Side mnt R, display face frwd, flow down
K	Side mnt, display face down, flow L-R	<i>For visual representation, refer to FCI drawing number 020943</i>	
L	Side mnt, display face down, flow R-L		

Code	[BLOCK 3] Power Supply
1	DC; 18 - 36 V
2	AC; 85 - 265 V, 50/60 Hz

Code	[BLOCK 4] Line Size
C	1/4" <i>(Available only with NPT, Block 5 must be Code E or N)</i> ⁵
E	1/2"
F	3/4"
G	1"
H	1-1/2"
J	2"

Code	[BLOCK 5] Process Connection Type
E	Female NPT
N	Male NPT
F	Flanged, #150 CLASS
W	Other; agency approved, customer specified <i>(If selected, Block 6 and 7 which follow must also be Code WW only)</i>

Code	[BLOCKS 6-7] Process Connection Size, Material, Rating, Finish Details
Q0	1/4" NPT <i>(Must be selected if Block 4 is Code C)</i>
H0	1/2" NPT
T0	3/4" NPT
10	1" NPT
B0	1-1/2" NPT
20	2" NPT
HG	1/2" ANSI flanged 150 lb RF ANSI 16.5, 316L SS
TG	3/4" ANSI flanged 150 lb RF ANSI 16.5, 316L SS
1G	1" ANSI flanged 150 lb RF ANSI 16.5, 316L SS
BG	1-1/2" ANSI flanged 150 lb RF ANSI 16.5, 316L SS
2G	2" ANSI flanged 150 lb RF ANSI 16.5, 316L SS
D3	DN15 DIN flanged PN40, Form C per DIN2526 or Form B1 per DIN EN1092-1 in 316L SS
E3	DN25 DIN flanged PN40, Form C per DIN2526 or Form B1 per DIN EN1092-1 in 316L SS
G3	DN40 DIN flanged PN40, Form C per DIN2526 or Form B1 per DIN EN1092-1 in 316L SS
J2	DN50 DIN flanged PN16, Form C per DIN2526 or Form B1 per DIN EN1092-1 in 316L SS
WW	Other; agency approved, customer specified

Code	[BLOCK 8] Gas Medium and System Calibration ²
B	Air
C	Air Equivalence (Oxygen, Chlorine, Ammonia, etc.)
E	Nitrogen, Helium, Argon, CO ₂ , Compressed Air
1	Natural gas (90% or greater methane content)
2	Natural gas (90% or greater methane content); line sizes smaller than 1 1/2"
F	Hydrocarbons (e.g. Ethane, Methane, Propane, Ethylene, Propylene, Mixed)
G	Hydrogen or hydrogen mixture
H	Air, Compressed Air
J	Air Equivalence (e.g. Oxygen, Chlorine, Ammonia, etc.)
K	Nitrogen, Argon
L	CO ₂ , Ethylene, Ethane
M	Propane, Propylene
N	Butane, Pentane
P	Methane, Helium
R	Hydrogen

Code	[BLOCK 9] Calibration ³ and Calibration Temperature Conditions
Q	High Accuracy 1% Calibration and Standard Conditions +40 °F to 100 °F [+4 °C to 38 °C] w/Vortab
T	High Accuracy 1% Calibration and Extended Temperature Compensation 0 °F to 250 °F [-18 °C to 121 °C] w/Vortab
W	Other, Agency approved, customer specified

Code	[BLOCK 10] Interconnecting Cable Length for Remote Configurations ⁴
0	Not required <i>(Specify with integral configurations)</i>
A	10' [3 meters]
B	25' [7,6 meters]
C	50' [15 meters]
W	Custom length <i>(Cannot exceed 50' [15 meters])</i>

Options and Accessories

Part Number	Description
FC88	Portable Hand-held Communicator
014108-02	PC Interface Communications Kit, For RS232 serial port connection
DM10-FC	DM10 with FM and CSA approvals
DM10-KIT1	Panel Mount Kit for DM10
DM10-KIT2	2" (52 mm) Pipe Mount Kit for DM10 (Stainless steel)
DM15	Digital Display/Readout, LED 115/230 Vac powered
DM15-ALM	Same as DM-15 with user programmable alarm limit, relay output

Notes

- Must use FCI's AVAL program to determine letter code. AVAL is a custom flow meter optimizer program which considers gas medium, flow range, pipe size and other conditions to determine best calibration and supplies FCI letter code to be used here. AVAL is available on-line at www.fluidcomponents.com or consult local FCI representative/distributor.
- Calibration accuracy is ±% of reading, ±0.5% of full scale.
- Fixed cable length with instrument calibrated together as a matched set. Cable may be coiled, but not cut.
- Certified Material Test Report (CMTR) not available with ST75V 1/4".

ST75 AV

Mass Flow Meter with Vortab® Flow Conditioner

ST75 AV -

												2
--	--	--	--	--	--	--	--	--	--	--	--	---

Block No. 1 2 3 4 5 6 7 8 9 10 11 12

INSTRUCTIONS: To order an **ST75 AV**, please fill in each numbered block above by selecting required codes from the corresponding categories below. Use of any "W" or "*" codes requires prior approval from FCI. For special data, documentation, test reports or required quality reports, refer to FCI's Engineering and Quality Assurance Order Information Sheets (OIS).

Code	[BLOCK 1] Base Unit, Enclosure Characteristics			
	Display	Integral or Remote	Cable Entries	Enclosure
1	No display	Integral	1/2" NPT	Aluminum
2	Display	Integral	1/2" NPT	Aluminum
4	Display	Remote	1/2" NPT	Aluminum
5	No display	Integral	1/2" NPT	Stainless steel
6	Display	Integral	1/2" NPT	Stainless steel
7	Display	Remote	1/2" NPT	Stainless steel
A	No display	Integral	M20 x 1.5	Aluminum
B	Display	Integral	M20 x 1.5	Aluminum
C	Display	Remote	M20 x 1.5	Aluminum
D	No display	Integral	M20 x 1.5	Stainless steel
E	Display	Integral	M20 x 1.5	Stainless steel
F	Display	Remote	M20 x 1.5	Stainless steel

Code	[BLOCK 2] Pipe Installation, Display/Transmitter Mounting Orientation and Flow Direction			
Code	Horizontal Pipe		Code	Vertical Pipe
F	Top mount, display/blind front facing forward, flow left-to-right		M	Side mount left, display/blind front facing forward, flow up
G	Top mount, display/blind front facing forward, flow right-to-left		N	Side mount right, display/blind front facing forward, flow up
H	Side mount, display/blind front facing up, flow left-to-right		P	Side mount left, display/blind front facing forward, flow down
J	Side mount, display/blind front facing up, flow right-to-left		R	Side mount right, display/blind front facing forward, flow down
K	Side mount, display/blind front facing down, flow left-to-right		<i>For visual representation, refer to FCI drawing number 020943</i>	
L	Side mount, display/blind front facing down, flow right-to-left			

Code	[BLOCK 3] Power Supply
1	DC; 18 - 36 V
2	AC; 85 - 265 V, 50/60 Hz

Code	[BLOCK 4] Line Size
C	1/4" (Available only with NPT, Block 5 must be Code E or N) ⁵
E	1/2"
F	3/4"
G	1"
H	1-1/2"
J	2"

Code	[BLOCK 5] Process Connection Type
E	Female NPT
N	Male NPT
F	Flanged, #150 CLASS
W	Other; agency approved, customer specified <i>(If selected, Block 6 and 7 which follow must also be Code WW only)</i>

Code	[BLOCKS 6-7] Process Connection Size, Material, Rating, Finish Details
Q0	1/4" NPT (Must be selected if Block 4 is Code C)
H0	1/2" NPT
T0	3/4" NPT
10	1" NPT
B0	1-1/2" NPT
20	2" NPT
HG	1/2" ANSI flanged 150 lb RF ANSI 16.5, 316L SS
TG	3/4" ANSI flanged 150 lb RF ANSI 16.5, 316L SS
1G	1" ANSI flanged 150 lb RF ANSI 16.5, 316L SS
BG	1-1/2" ANSI flanged 150 lb RF ANSI 16.5, 316L SS
2G	2" ANSI flanged 150 lb RF ANSI 16.5, 316L SS
D3	DN15 DIN flanged PN40, Form C per DIN2526 or Form B1 per DIN EN1092-1 in 316L SS
E3	DN25 DIN flanged PN40, Form C per DIN2526 or Form B1 per DIN EN1092-1 in 316L SS
G3	DN40 DIN flanged PN40, Form C per DIN2526 or Form B1 per DIN EN1092-1 in 316L SS
J2	DN50 DIN flanged PN16, Form C per DIN2526 or Form B1 per DIN EN1092-1 in 316L SS
WW	Other; agency approved, customer specified

Code	[BLOCK 8] Gas Medium and System Calibration ²
B	Air
C	Air equivalence (Oxygen, Chlorine, Ammonia, etc.)
E	Nitrogen, Helium, Argon, CO ₂ , compressed air
1	Natural gas (90% or greater methane content)
2	Natural gas (90% or greater methane content); line sizes smaller than 1 1/2"
F	Hydrocarbons (e.g. Ethane, Methane, Propane, Ethylene, Propylene, mixed)
G	Hydrogen or hydrogen mixture
H	Air, compressed air
J	Air equivalence (e.g. Oxygen, Chlorine, Ammonia, etc.)
K	Nitrogen, Argon
L	CO ₂ , Ethylene, Ethane
M	Propane, Propylene
N	Butane, Pentane
P	Methane, Helium
R	Hydrogen
W	Other, factory approved special calibration

Code	[BLOCK 9] Calibration ³ and Conditions
Q	High accuracy 1% calibration with Vortab
T	High accuracy 1% calibration and extended temperature compensation with Vortab
W	Other, agency approved, customer specified

(continued next page)

Notes

2. Must use FCI's AVAL program to determine letter code. AVAL is a custom flow meter optimizer program which considers gas medium, flow range, pipe size and other conditions to determine best calibration and supplies FCI letter code to be used here. AVAL is available on-line at www.fluidcomponents.com or consult local FCI representative/distributor.
3. Calibration accuracy is ±% of reading, ±0.5% of full scale.
5. Certified Material Test Report (CMTR) not available with ST75 AV 1/4".

(continued from previous page)

Code	[BLOCK 10] Interconnecting Cable Length for Remote Configurations
0	Not required (Specify with integral configurations) ⁸
A	10' [3 meters]
B	25' [7,6 meters]
C	50' [15 meters]
D	100' [30 meters]
W	Custom length
Code	[BLOCK 11] Transmitter Options
2	HART communications
Code	[BLOCK 12] Agency Approval
CE Mark always included	
0	Not required, CE Mark only
1	FM, FMc
3	ATEX, IECEx ⁸
*	Other Contact FCI for other approvals and conditions of use

Notes

- ATEX/IECEx rated remote requires cable glands or conduit fittings which meet or exceed the installation area's required rating. When rated cable glands, armored cable and non-armored cable are user-supplied, or selected separately from FCI accessories list, enter Code 0 in Block 10.

Accessories

Part Number	Description
FC88	Portable Hand-held Communicator
014108-03	PC Interface Communications Kit, For RS232 serial port connection

NOTICE OF PROPRIETARY RIGHTS
This document contains confidential technical data, including trade secrets and proprietary information, which is the property of Fluid Components International LLC (FCI). Disclosure of this data to you is expressly conditional upon your assent that its use is limited to use within your company only (and does not include manufacture or processing uses). Any other use is strictly prohibited without prior written consent of FCI.

REV	DESCRIPTION	DATE
B	ECN002416	8/24/15

INTEGRAL HORIZONTAL MOUNTINGS

CODE F:

TOP MNT.
DISPLAY/BLIND FRONT FORWARD
FLOW LEFT TO RIGHT

CODE G:

TOP MNT.
DISPLAY/BLIND FRONT FORWARD
FLOW RIGHT TO LEFT

CODE H:

SIDE MOUNT.
DISPLAY/BLIND FRONT UP
FLOW LEFT TO RIGHT

CODE J:

SIDE MOUNT.
DISPLAY/BLIND FRONT UP
FLOW RIGHT TO LEFT

CODE K:

SIDE MOUNT.
DISPLAY/BLIND FRONT DOWN
FLOW LEFT TO RIGHT

CODE L:

SIDE MOUNT.
DISPLAY/BLIND FRONT DOWN
FLOW RIGHT TO LEFT

INTEGRAL VERTICAL MOUNTINGS

CODE M:

SIDE MOUNT LEFT
DISPLAY/BLIND FRONT FORWARD
FLOW UP

CODE N:

SIDE MOUNT RIGHT
DISPLAY/BLIND FRONT FORWARD
FLOW UP

CODE P:

SIDE MOUNT LEFT
DISPLAY/BLIND FRONT FORWARD
FLOW DOWN

CODE R:

SIDE MOUNT RIGHT
DISPLAY/BLIND FRONT FORWARD
FLOW DOWN

▲ FLOW ARROW ON TOP AS SHOWN.

- THE LCD DISPLAY CAN BE USER ROTATED AND VIEWED AT ANY 90 DEGREE ORIENTATION.
- IN REMOTE ELECTRONIC CONFIGURATIONS, THE LOCAL ENCLOSURE WILL BE ORIENTED AS SHOWN WITH SOLID COVER ON BOTH SIDES. INTERCONNECTING TERMINALS LOCATED INSIDE.
- THIS DRAWING IS GENERIC IN NATURE, FOR SPECIFIC MODEL TYPE, ORIENTATION, CUSTOMER PROCESS CONNECTION, ETC, REFER TO IO&M MANUAL.

NOTES: UNLESS OTHERWISE SPECIFIED

DESIGNED BY	DATE	APPROVALS
ED Posquel	06/24/2015	ED Posquel
DESIGNED BY	DATE	APPROVALS
Spem. Kresch	06/24/2015	Ed Posquel
DESIGNED BY	DATE	APPROVALS
N/A	06/24/2015	N/A
DESIGNED BY	DATE	APPROVALS
Motony Patern	06/24/2015	N/A
DESIGNED BY	DATE	APPROVALS
N/A	06/24/2015	N/A
DESIGNED BY	DATE	APPROVALS
Burt Tanaka	06/24/2015	N/A

PRODUCT CODE	APPL.	DATE
N/A		06/24/2015
DESIGNED BY	DATE	APPROVALS
Ed Posquel	06/24/2015	Ed Posquel
DESIGNED BY	DATE	APPROVALS
Spem. Kresch	06/24/2015	Ed Posquel
DESIGNED BY	DATE	APPROVALS
N/A	06/24/2015	N/A
DESIGNED BY	DATE	APPROVALS
Motony Patern	06/24/2015	N/A
DESIGNED BY	DATE	APPROVALS
N/A	06/24/2015	N/A
DESIGNED BY	DATE	APPROVALS
Burt Tanaka	06/24/2015	N/A

FCI FLUID COMPONENTS INTERNATIONAL LLC
SAN MARCO, CA 92078

TITLE: ST75/ST75V, ASSEMBLY ORIENTATION

SIZE	ONE CODE	DWG NO.	REV
D	64818	020943	B
SCALE	NONE	SHEET	1 OF 1