

# PRESSURE MONITOR

WITH ONE HIGH / LOW ALARM OUTPUT.



## Advantages

- Robust IP67 (NEMA4X) field enclosure. It is so rugged, **you can even stand on it!**
- Intrinsically Safe available - ATEX, IECEx, FM and CSA approval for gas and dust applications.
- Programming can be done by your own crew, with the sensible menu-driven structure, saving cost and irritation. **Know one, know them all!**
- Very diverse mounting possibilities: walls, pipes, panels or directly onto outdoor sensors!

## Features

- Displays actual pressure and alarm values.
- Two alarm values can be entered: low and high pressure alarm.
- Large 17mm (0.67") digits.
- Selectable on-screen engineering units: mBar - Bar - PSI.
- Red flashing backlight in case of a pressure alarm.
- Explosion/flame proof  II 2 GD EEx d IIB T5.
- Loop or battery powered, 8 - 24V AC/DC or 115 - 230V AC power supply.
- Sensor supply 8.2 / 12 / 24V DC.

## Signal output

- One free configurable alarm output.

## Signal input

### Pressure

- (0)4 - 20mA.
- 0 - 10V DC.

## Applications

- The F-Series is your first and safest choice for field mount indicators. Especially in harsh weather conditions like rain, snow, salty atmospheres and temperatures between -40°C up to +80°C (-40°F up to 176°F) for safe and hazardous area applications!
- For applications where continuous pressure measurement and monitoring is important. Alternative basic model: F050 or more advanced F153 or the D-Series DIN panel mount indicators.

## General information

### Introduction

The F053 is a versatile pressure indicator with continuous pressure monitoring feature. It offers the facility to set one low pressure and one high pressure alarm value. If desired, an ignore function can be set up to allow for an incorrect pressure for a certain period of time. A wide selection of options further enhances the capabilities of this model, including Intrinsic Safety.

### Display

The display has large 17mm (0.67") and 8mm (0.31") digits which displays the pressure, measuring unit and alarm values. As the F053 has been designed for field mounted applications, a smart display update function has been incorporated. Related to the lower temperature, the update frequency of the LCD is tuned automatically to achieve a readable display even at -40°C / -40°F.

### Backlight

The tri-color backlight in combination with the F053 offers a unique feature: in case of a pressure alarm, the backlight can be set to be red or flashing red / green. The background color can be set to green or amber and the intensity can be adjusted from the keyboard. The display is a transfective type, which means that a high contrast reading is guaranteed in full sunlight as well as during the night. This backlight option is also available Intrinsically Safe.

### Configuration

All configuration settings are accessed via a simple operator menu which can be password protected. Each setting is clearly indicated with an alphanumerical description, which avoids - confusing abbreviations. All settings are safely stored in EEPROM memory in the event of sudden power failure.

### Alarm output

One alarm output is available to transmit the pressure alarm. It can be set to switched for a low, high or both alarms! The output signal can be a passive NPN, active PNP or an isolated electro-mechanical relay.

### Signal input

The F053 does accept (0)4 - 20mA and 0 - 10V input signals from any type of pressure measurement device. Also a 4 - 20mA input loop powered model is available.

### Power requirements

Several power supply options are available to power the F053 and sensor. A battery powered version with a long life lithium battery which will last up to five years. A 4-20mA input loop powered version is available as well. A real sensor supply is offered with the 24V AC/DC or 115-230V AC power requirement options.

### Hazardous area

For hazardous area applications, this model has been ATEX, IECEx, FM and CSA certified Intrinsically Safe for gas and dust applications, with an allowed ambient temperature of -40°C to +70°C (-40°F to +158°F). A flame proof enclosure with ATEX certification offers the rating  $\text{Ex} \text{II} \geq \text{GD} \text{EEx} \text{d} \text{IIB} \text{T5}$ .

### Enclosures

Various types of enclosures can be selected, all ATEX, IECEx, FM and CSA approved. As standard the F053 is supplied in an GRP panel mount enclosure, which can be converted to an IP67 / NEMA 4X GRP field mount enclosure by the addition of a back case. Most popular is our aluminum field mount enclosure with IP67 / NEMA 4X rating. Both European or U.S. cable gland entry threads are available.

## Overview application F053

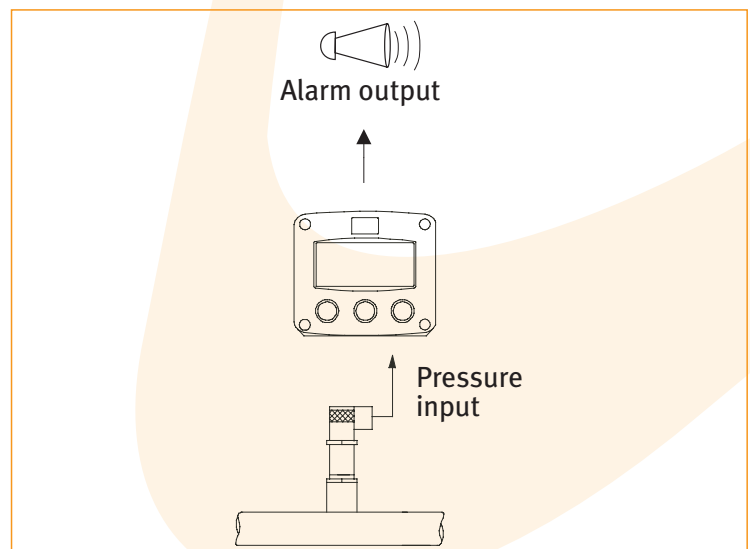

## Dimensions enclosures Aluminum & GRP panel mount enclosure

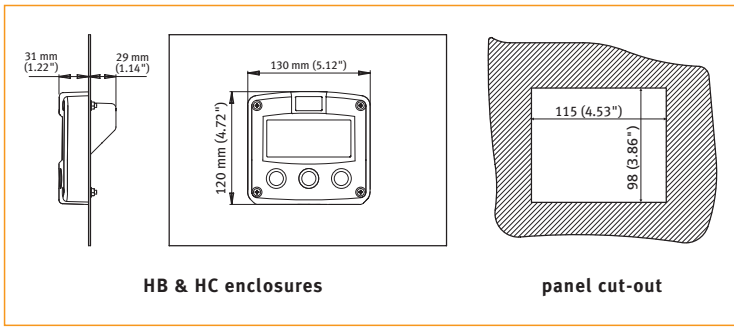

## Aluminum & GRP field / wall mount enclosures

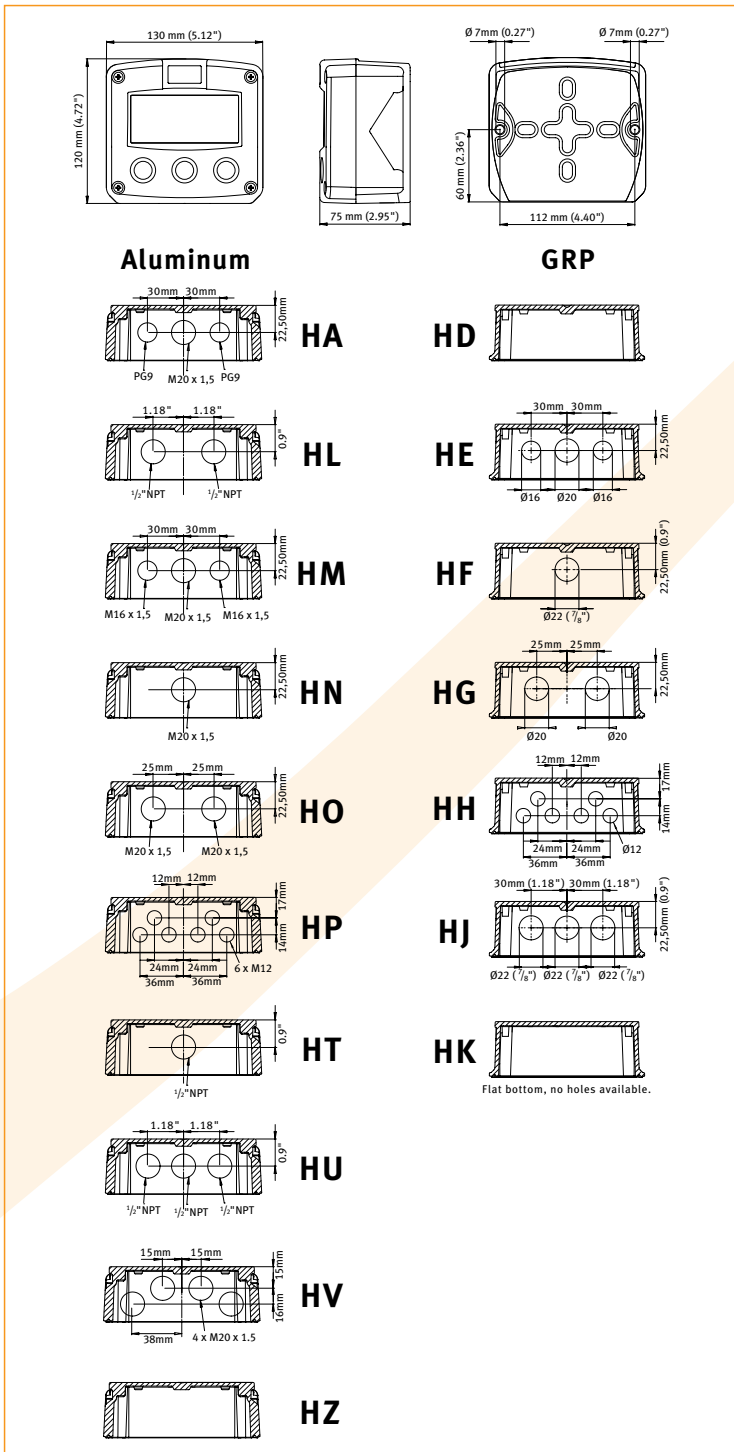

## Terminal connections PB/PC - PD - PL - PX

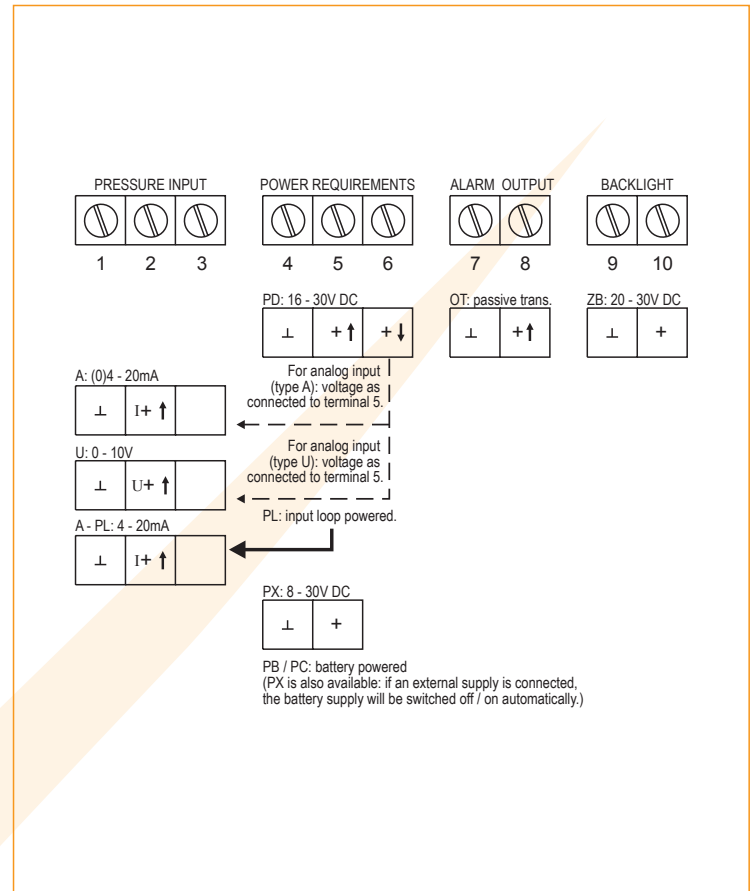

## Terminal connections PF - PM

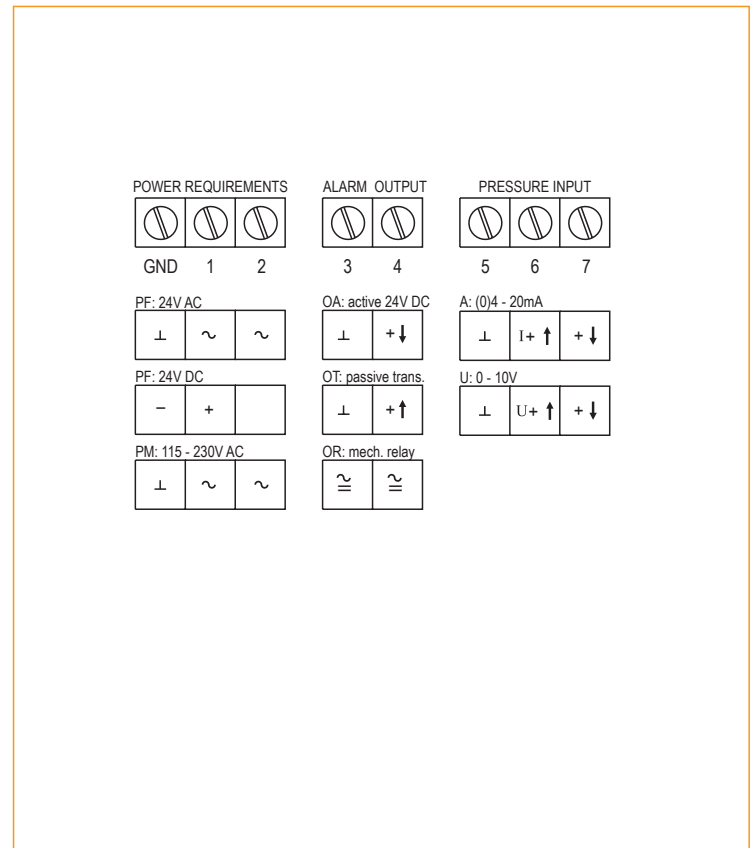

Typical wiring diagram Fo53-A-(OT)-PB-(PX)

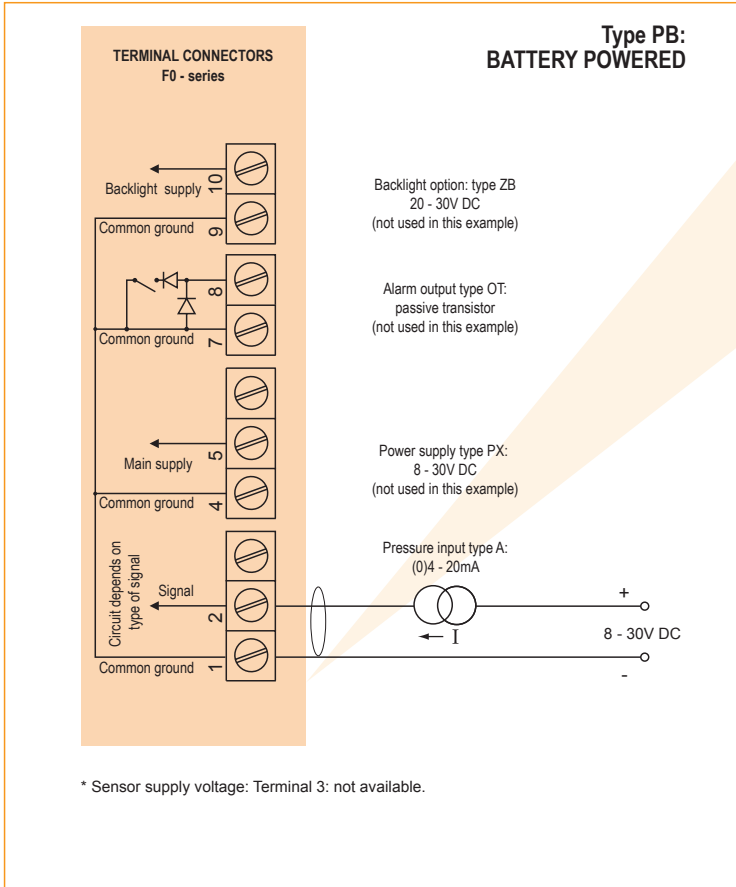

Typical wiring diagram Fo53-A-OT-PX-ZB

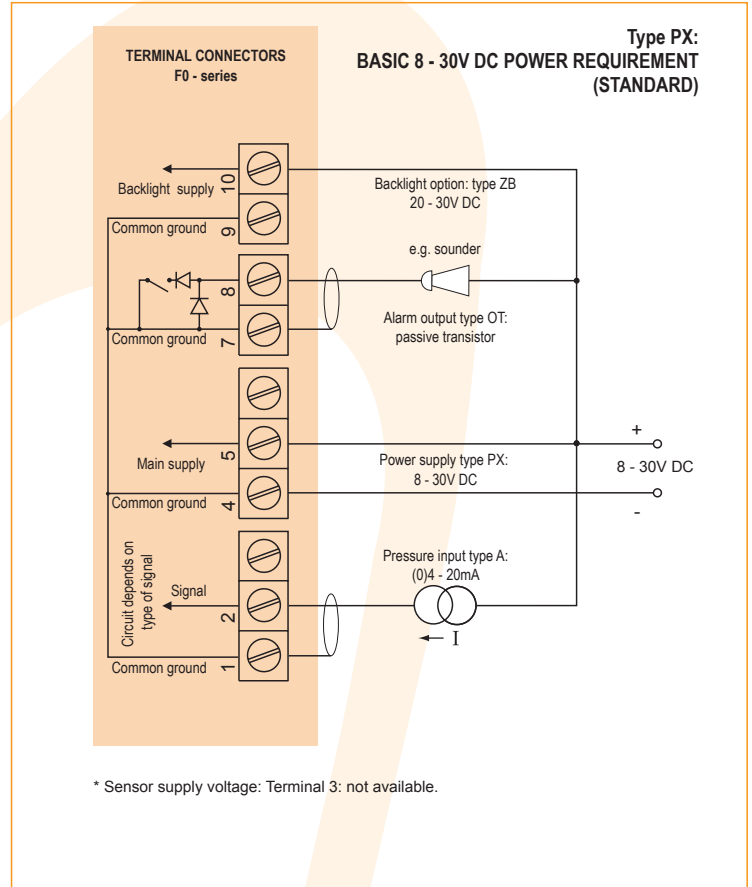

Typical wiring diagram Fo53-A-(OT)-PL-ZB

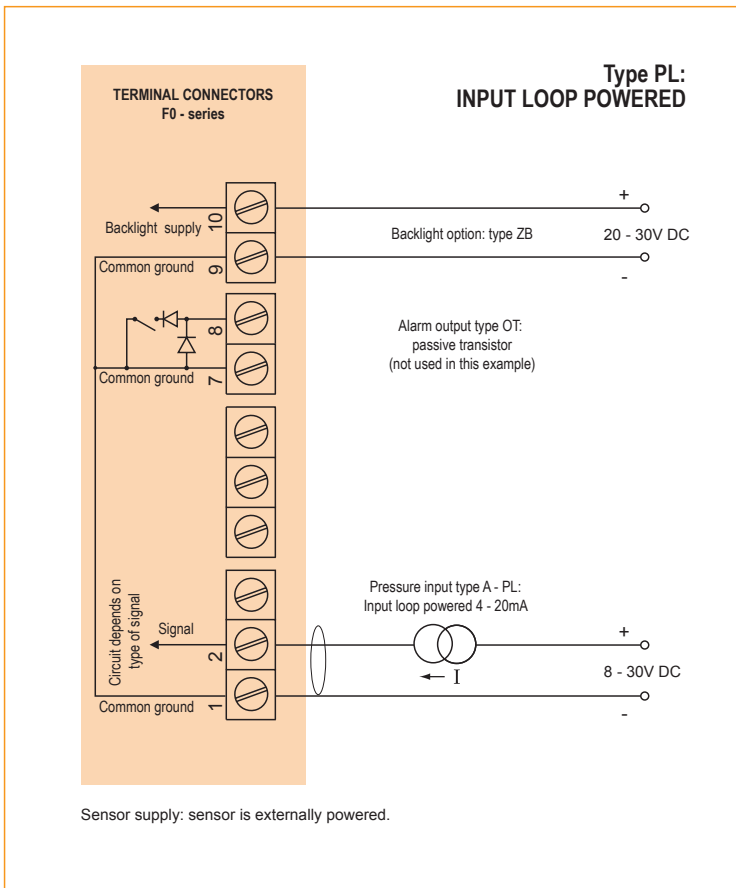

Typical wiring diagram Fo53-A-OT-PD-ZB

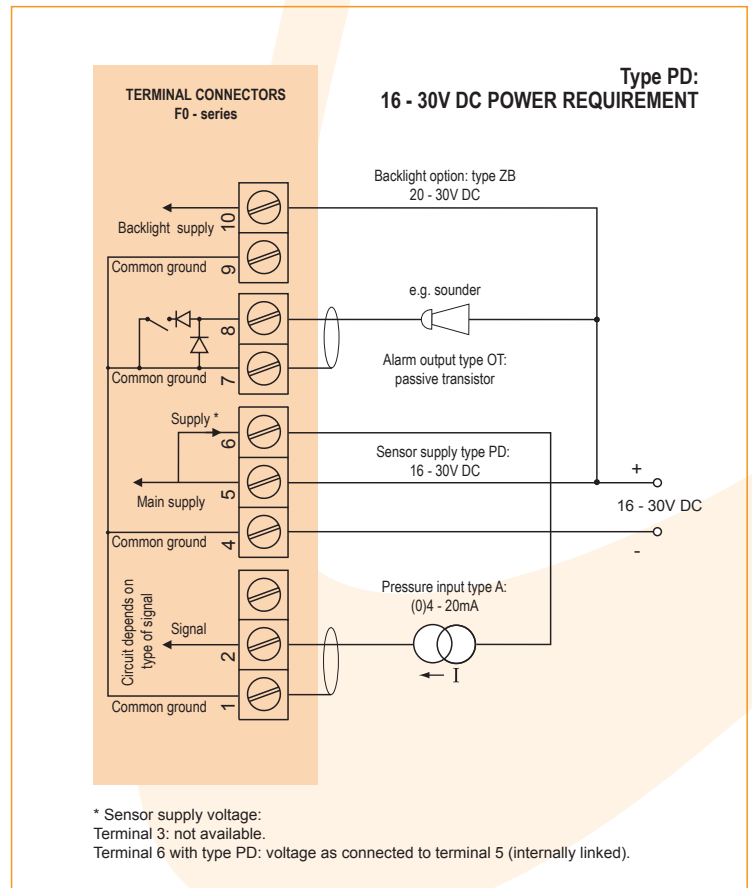

Typical wiring diagram F053-A-OA-PF-ZB

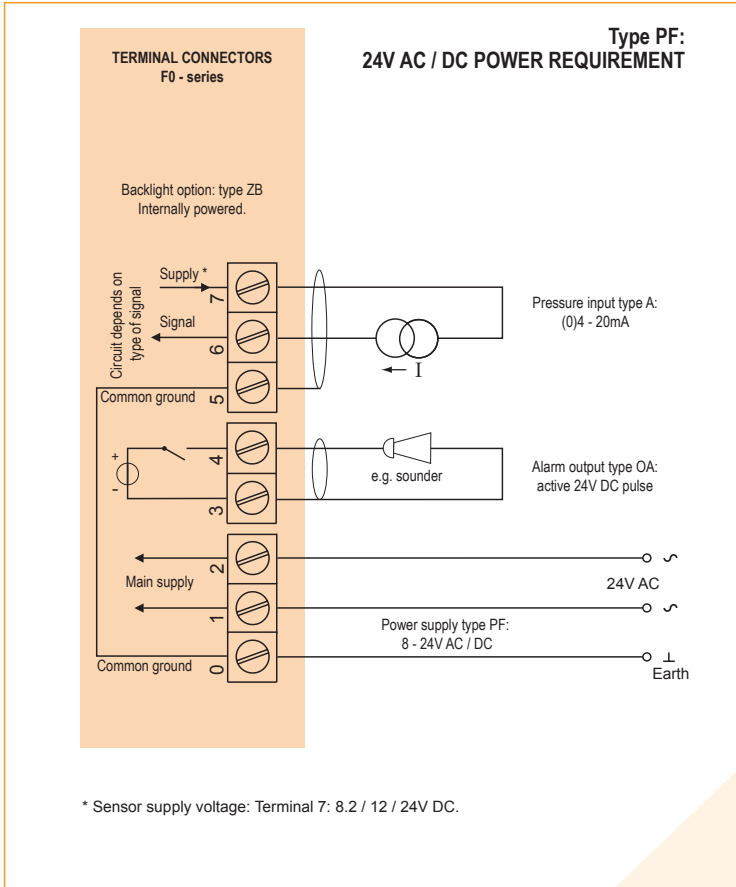

Typical wiring diagram F053-A-OT-PF-ZB

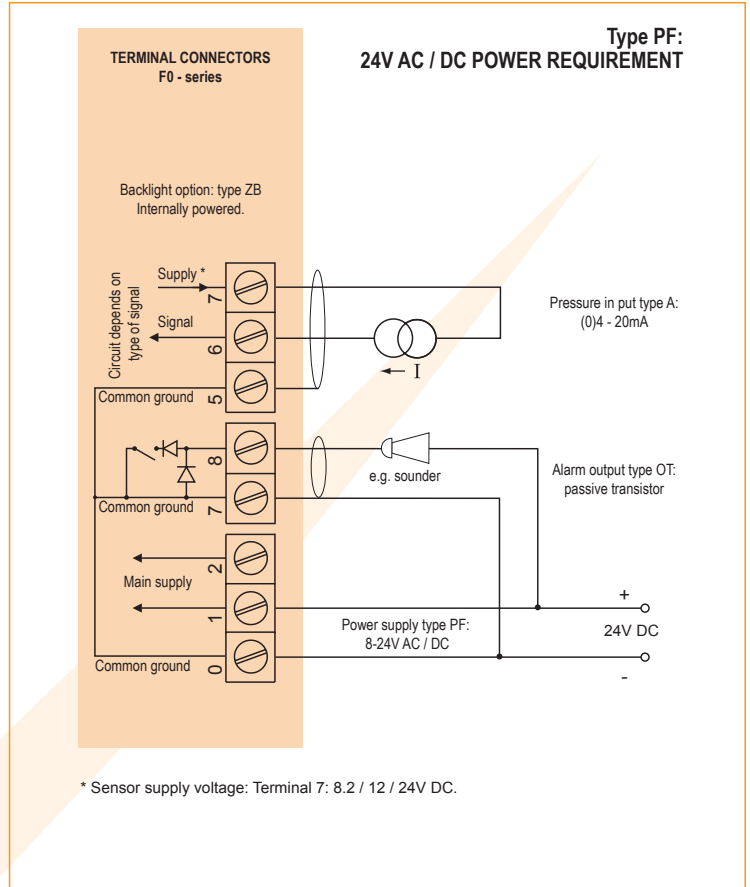

Typical wiring diagram F053-A-OA-PM-ZB

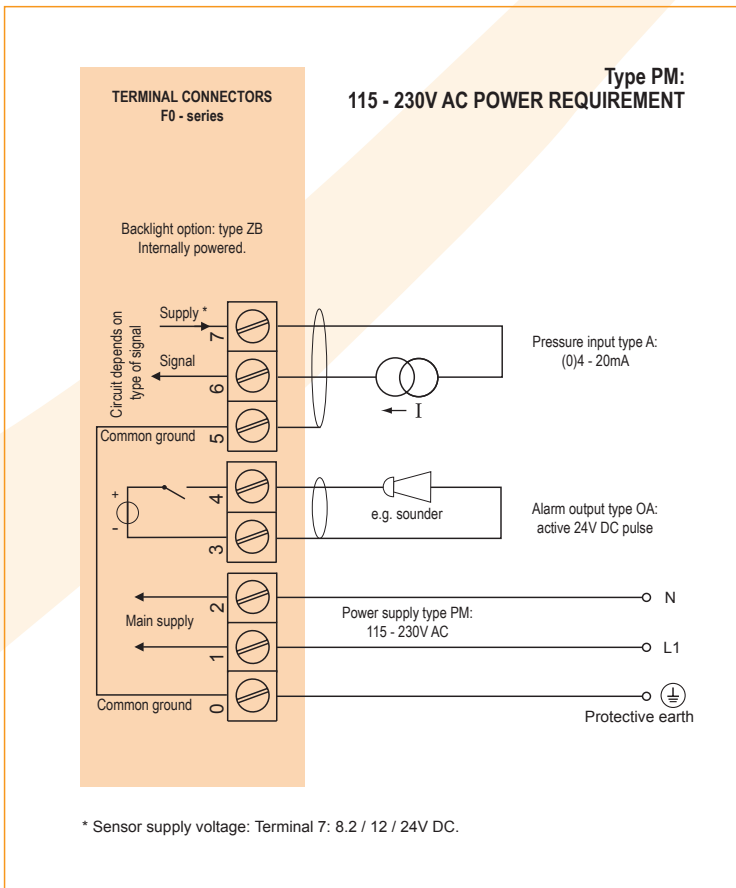

Typical wiring diagram F053-A-OR-PM-ZB

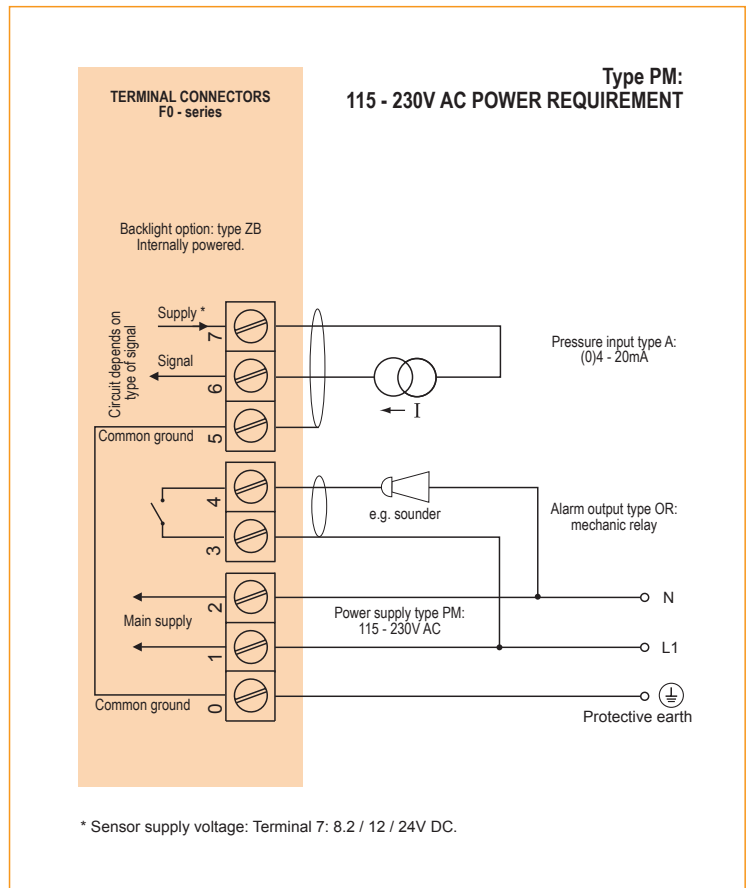

## Hazardous area applications

The F053-XI has been certified according ATEX and IECEx by KEMA and according CSA c-us and FM for use in Intrinsically Safe applications with an ambient temperature of -40°C to +70°C (-40°F to +158°F).

- The ATEX markings for gas and dust applications are:

**II 1 G Ex ia IIC T4**  
**II 1 D Ex iaD 20 IP 65/67 T 100 °C.**

- The IECEx markings for gas and dust applications are: **Ga Ex ia IIC T4** and **Ex iaD 20 IP 65/67 T100 °C.**
- The CSA c-us markings are: **Class I/II/III, Division 1, Groups A, B, C, D, E, F, G, Temperature class T4** and **Class I, Zone o, AEx ia IIC T4.**
- The FM markings are: **Class I/II/III, Division 1, Groups A, B, C, D, E, F, G, Temperature class T4** and **Class I, Zone o, AEx ia IIC T4.**

It is allowed to connect up to three I.S. power supplies to power the unit, sensor and back-light. Consult the certificate for the maximum input and output values of the circuits.

The F053-PD-XI offers the input voltage to power an analog sensor. An ATEX approved flame proof enclosure with rating  $\text{Ex} \text{ II } \geq \text{GD}$  EEx d IIB T5 is available as well. Please contact your supplier for further details.

### Certificate of conformity KEMA 05ATEX1168 X

• IECEx KEM 08.0006X • CSA.08.2059461 X

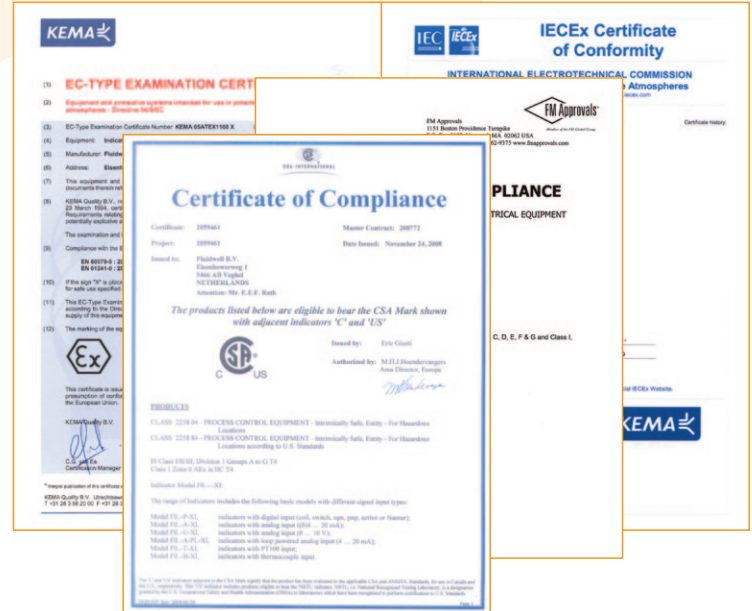

### Configuration example IIA - IIB and IIC - F053-A-OT-PX-XI-ZB - Basic power requirement 8 - 30V DC

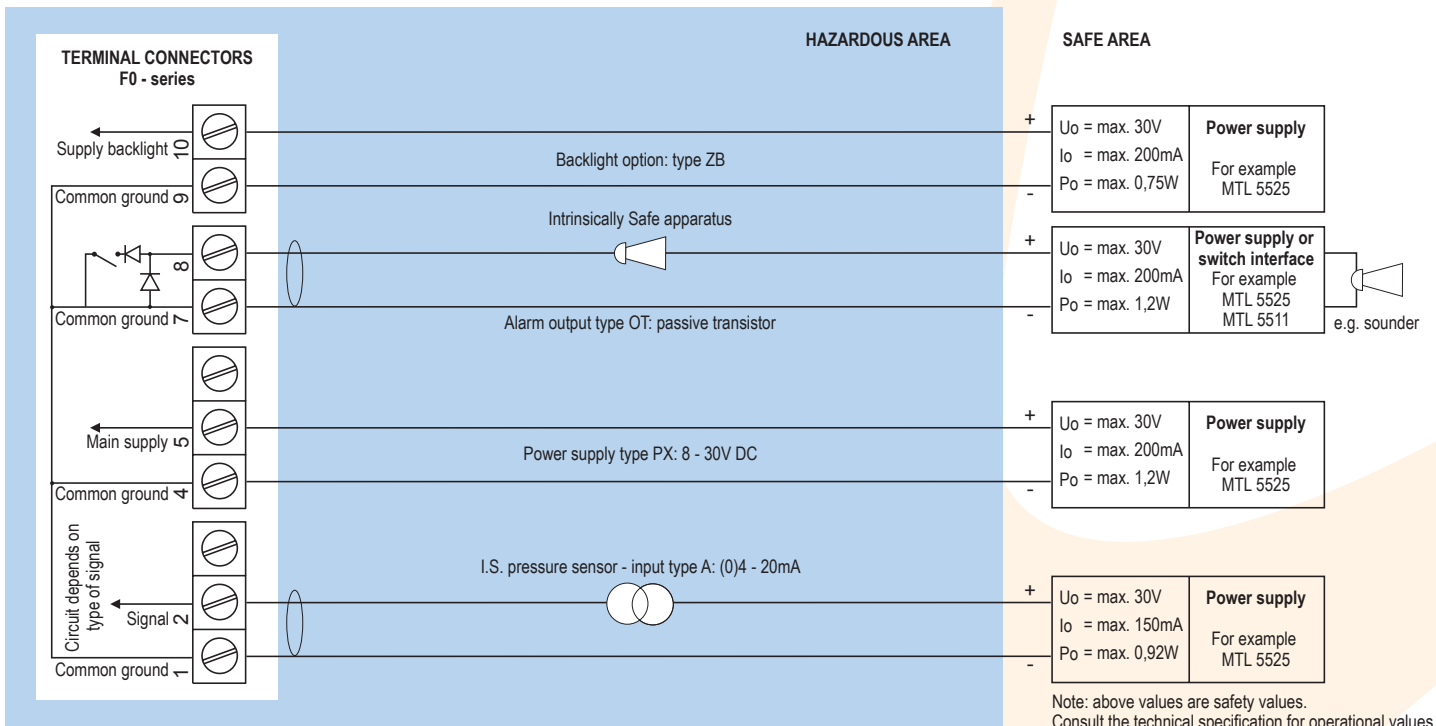

Note: above values are safety values. Consult the technical specification for operational values.

\* Sensor supply voltage for analog pressure sensor type A / U; not available in this example. Please note: type PX may be used in combination with the battery (type PC). PX will power the unit; the battery will be disabled automatically till power is disconnected.

## Configuration example IIA - IIB and IIC - F053-A-OT-PD-XI-ZB - Power requirement 16 - 30V DC

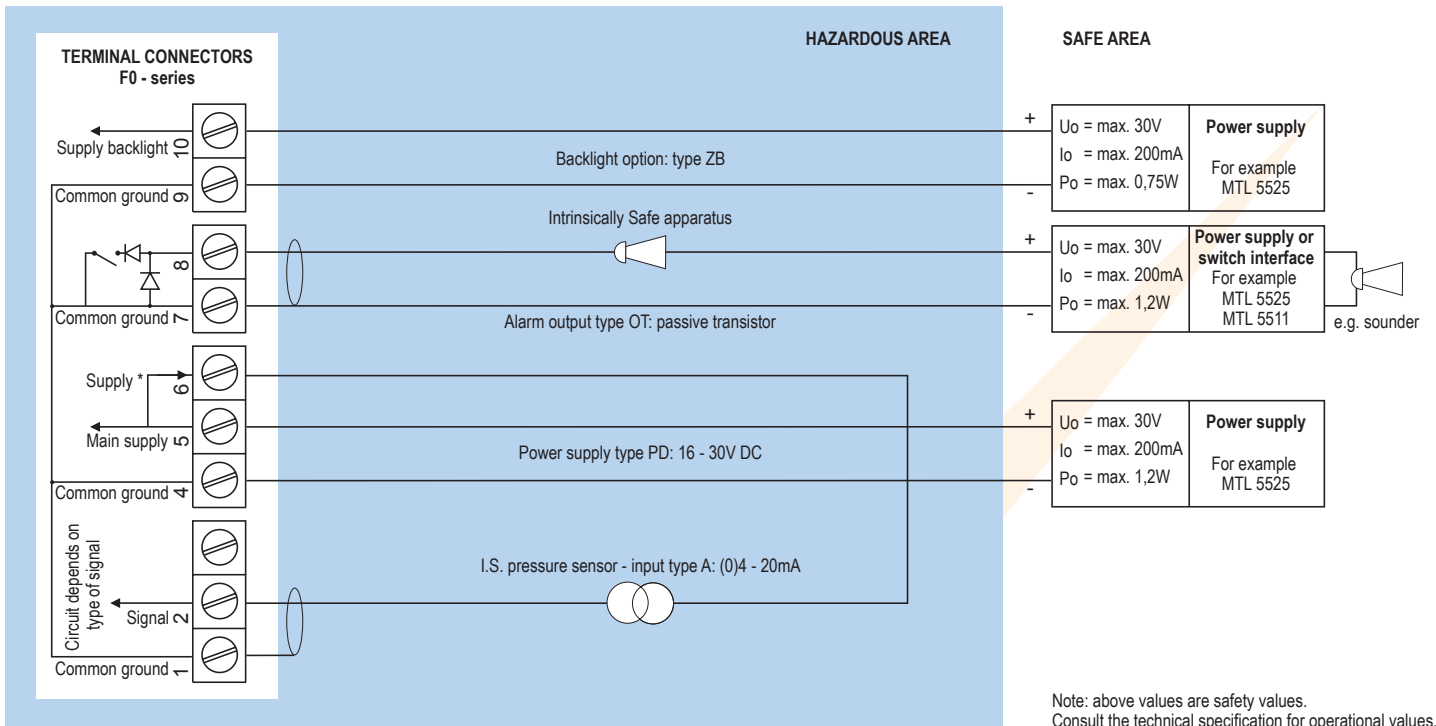

\* Sensor supply voltage for analog pressure sensor type A / U: Terminal 6: as input voltage terminal 5 (internally linked).  
Please note: type PD may be used in combination with the battery (type PC). PD will power the unit; the battery will be disabled automatically till power is disconnected.

## Configuration example IIA - IIB and IIC - F053-A-OT-PL-XI-ZB - Input loop powered

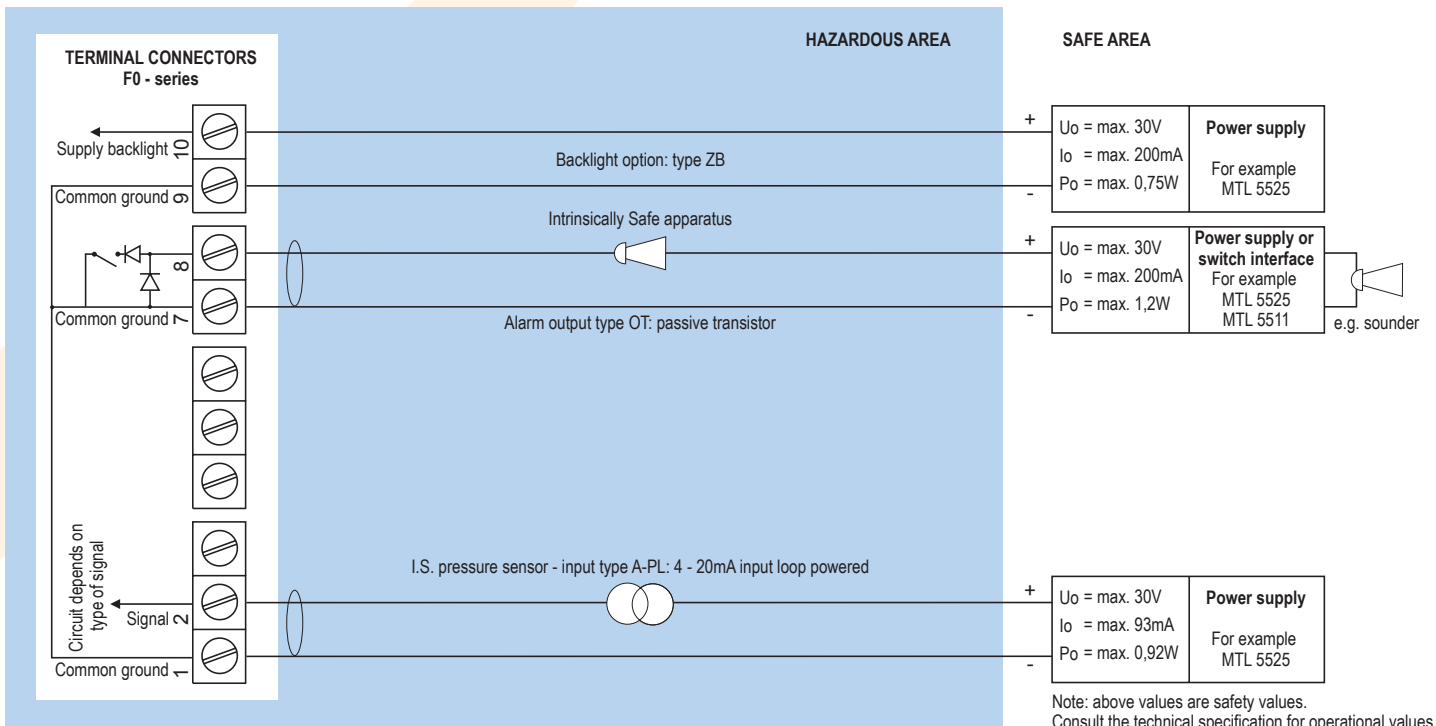

Sensor supply is not available: unit is input loop powered (type PL).  
Please note: type PL may be used in combination with the battery (type PC). PL will power the unit; the battery will be disabled automatically till power is disconnected.

## Technical specification

### General

Display	
Type	High intensity reflective numeric and alphanumeric LCD, UV-resistant.
Dimensions	90 x 40mm (3.5" x 1.6").
Digits	Seven 17mm (0.67") and eleven 8mm (0.31") digits. Various symbols and measuring units.
Refresh rate	User definable: fast, 1sec, 3sec, 15sec, 30sec, off.
Option ZB	Transflective LCD with tri-color LED-backlight; green /amber. Red (flashing) backlight during alarm conditions. Intensity, color and alarm response selected through the keyboard. Good readings in full sunlight and darkness. Also available Intrinsically Safe.

### Ambient temperature

Safe areas	-40°C to +80°C (-40°F to +176°F).
Intrinsically Safe	-40°C to +70°C (-40°F to +158°F).

### Power requirements

Type PB	Long life Lithium battery - life-time depends upon settings and configuration - up to 5 years.
Type PC	Intrinsically Safe long life lithium battery - life-time depends upon settings and configuration - up to 5 years.
Type PD	16 - 30V DC. Power consumption max. 1 Watt.
Type PF	24V AC / DC ± 10%. Power consumption max. 15 Watt.
Type PL	Input loop powered from sensor signal 4 - 20mA (type A).
Type PM	115 - 230V AC ± 10%. Power consumption max. 15 Watt.
Type PX	8 - 30V DC. Power consumption max. 0.3 Watt.
Type ZB	20 - 30V DC. Power consumption max. 1 Watt. With type PF / PM: internally powered.
Note PB/PF/PM	Not available Intrinsically Safe.
Note PF/PM	The total consumption of the sensor, active output type OA and backlight type ZB may not exceed 400mA @ 24V DC.
Note	For Intrinsically Safe applications, consult the safety values in the certificate.

### Sensor excitation

Type PB/PC/PX	Not available.
Type PD	The sensor supply voltage will be according to power supply voltage (as connected to terminal 5).
Type PF / PM	8.2 / 12 / 24V DC - max. 400mA @ 24V DC.

### Terminal connections

Type	Removable plug-in terminal strip. Wire max. 1.5mm <sup>2</sup> and 2.5mm <sup>2</sup> .
------	---

### Data protection

Type	EEPROM backup of all settings. Data retention at least 10 years.
Password	Configuration settings can be password protected.

### Directives & Standards

EMC	Directive 2004/108/EC, FCC 47 CFR part 15.
Low voltage	Directive 2006/95/EC.
ATEX / IECEx	Directive 94/9/EC, IEC 60079-0, IEC 60079-11, IEC 60079-26.
FM	FM Class No. 3600, FM Class No. 3610.
CSA	CSA 22.2 No. 157-92.
IP & NEMA	EN 60529 & NEMA 250.

### Enclosure

General	
Window	Polycarbonate window.
Sealing	Silicone.
Control keys	Three industrial micro-switch keys. UV-resistant silicone keypad.

### Aluminum wall / field mount enclosures

General	Die-cast aluminum wall/field mount enclosure IP67 / NEMA 4X with 2-component UV-resistant coating.
Dimensions	130 x 120 x 75mm (5.12" x 4.72" x 2.95") - W x H x D.
Weight	1100 gr.
Type HA	Cable entry: 2 x PG9 and 1 x M20.
Type HL	Cable entry: 2 x 1/2" NPT.
Type HM	Cable entry: 2 x M16 and 1 x M20.
Type HN	Cable entry: 1 x M20.
Type HO	Cable entry: 2 x M20.
Type HP	Cable entry: 6 x M12.
Type HT	Cable entry: 1 x 1/2" NPT.
Type HU	Cable entry: 3 x 1/2" NPT.
Type HV	Cable entry: 4 x M20.
Type HZ	Cable entry: no holes.





### GRP wall / field mount enclosures

General	GRP wall/field mount enclosure IP67 / NEMA 4X, UV-resistant and flame retardant.
Dimensions	130 x 120 x 75mm (5.12" x 4.72" x 2.95") - W x H x D.
Weight	600 gr.
Type HD	Cable entry: no holes.
Type HE	Cable entry: 2 x Ø 16mm and 1 x Ø 20mm.
Type HF	Cable entry: 1 x Ø 22mm (7/8").
Type HG	Cable entry: 2 x Ø 20mm.
Type HH	Cable entry: 6 x Ø 12mm.
Type HJ	Cable entry: 3 x Ø 22mm (7/8").
Type HK	Flat bottom, cable entry: no holes.

### Panel mount enclosures

Dimensions	130 x 120 x 60mm (5.12" x 4.72" x 2.36") - W x H x D.
Panel cut-out	115 x 98mm (4.53" x 3.86") L x H.
Type HB	Die-cast aluminum panel mount enclosure IP65 / NEMA 4X.
Weight	600 gr.
Type HC	GRP panel mount enclosure IP65 / NEMA 4X, UV-resistant and flame retardant.
Weight	450 gr.

### Hazardous area

Intrinsically Safe	
ATEX certification	 II 1 G Ex ia IIC T4. II 1 D Ex iaD 20 IP 65 / 67 T 100 °C.
IECEx certification	 Ga Ex ia IIC T4. Ex iaD 20 IP 65 / 67 T 100 °C.
CSA c-us certification	 Intrinsically Safe for Class I/II/III, Div. 1, Groups A, B, C, D, E, F, G, Temp. class T4 and Class I, Zone o, AEx ia IIC T4.
FM certification	 Intrinsically Safe for Class I/II/III, Div. 1, Groups A, B, C, D, E, F, G, Temp. class T4 and Class I, Zone o, AEx ia IIC T4.
Ambient Ta	-40°C to +70°C (-40°F to +158°F).



## Explosion proof

ATEX certification	Ex II 2 GD EEx d IIB T5.
Type XF	Dimensions of enclosure: 300 x 250 x 200mm (11.8" x 9.9" x 7.9") L x H x D.
Weight	Appr. 15kg.

## Signal input

### Pressure sensor

Type A	(0)4 - 20mA. Analog input signal can be scaled to any desired range within 0 - 20mA.
Type U	0 - 10V DC. Analog input signal can be scaled to any desired range within 0 - 10V DC.
Accuracy	Resolution: 16 bit. Error < 0.01mA / ± 0.05% FS. Low level cut-off programmable.
Span	0.001 / 999,999 with variable decimal position.
Offset	-999,999 / +999,999 units.
Update time	Four times per second.
Voltage drop	Type A: max. 1V DC @ 20mA.
Voltage drop	Type A - PL (loop powered): max. 2.6V DC @ 20mA.
Load impedance	Type U: 3kOhm.
Relationship	Linear and square root calculation.
Note	For signal type A and U: external power to sensor is required; e.g. type PD.

## Signal output

### Digital output

Function	User defined: low, high or both alarms output.
Type OA	One active 24V DC transistor output (PNP); load max. 400mA (requires PF or PM).
Type OR	One electro-mechanical relay output - isolated; max. switch power 230V AC (N.O.) - 0.5A (requires PF or PM).
Type OT	One passive transistor output (NPN) - not isolated. Max. 50V DC - 300mA per output.

## Operational

### Operator functions

Displayed functions	<ul style="list-style-type: none"> <li>Actual pressure.</li> <li>Low alarm value.</li> <li>High alarm value.</li> <li>Alarm values can be set as % (or only displayed).</li> </ul>
---------------------	--

### Pressure

Digits	7 digits.
Units	mbar, bar, PSI, no-unit.
Decimals	0 - 1 - 2 or 3.

### Alarm values

Digits	7 digits.
Units	According to the settings for pressure.
Decimals	According to the settings for pressure.
Time units	According to the settings for pressure.
Type of alarm	Low and high pressure alarm. Includes alarm delay time and configurable alarm output.

## Accessories

### Mounting accessories

ACFo2	Stainless steel wall mounting kit.
ACFo5	Stainless steel pipe mounting kit (worm gear clamps not included).
ACFo6	Two stainless steel worm gear clamps Ø 44 - 56mm.
ACFo7	Two stainless steel worm gear clamps Ø 58 - 75mm.
ACFo8	Two stainless steel worm gear clamps Ø 77 - 95mm.
ACFo9	Two stainless steel worm gear clamps Ø 106 - 138mm.
ACF10	Customized Grevopal tagplates for ACFo2 and ACFo5, including stainless steel screws. Dimension: 95mm x 12.5mm (3.75" x 0.50").

### Cable glands

ACF20	For HA enclosure, includes O-rings.
ACF25	For HE enclosure, includes locknuts and O-rings.
ACF26	For HF enclosure, includes locknuts and O-rings.
ACF27	For HG enclosure, includes locknuts and O-rings.
ACF28	For HH enclosure, includes locknuts and O-rings.
ACF29	For HJ enclosure, includes locknuts and O-rings.
ACF32	For HM enclosure, includes O-rings.
ACF33	For HN enclosure, includes O-rings.
ACF34	For HO enclosure, includes O-rings.
ACF35	For HP enclosure, includes O-rings.
ACF39	For HT enclosure, includes O-rings.
ACF40	For HU enclosure, includes O-rings.

### Intrinsically Safe isolators

ACGo1	MTL5511 - One channel pulse or switch output transfer from hazardous area to safe area.
ACGo2	MTL5525 - One channel power supply from safe area to hazardous area (e.g. to power the unit with PD or to power a switching or analog device in hazardous area).
ACGo3	MTL5541 - One channel 4 - 20mA repeater from hazardous area to safe area.
ACGo4	MTL 5051 - Bi-direction serial-data-isolator (for Modbus communication).
ACGo5	MTL5516C - Two channel pulse or switch output transfer from hazardous area to safe area.
ACGo6	MTL5513 - One channel pulse or switch output transfer from hazardous area to safe area.
ACGo7	MTL5546Y - One channel isolated driver bringing 4 - 20mA from safe area to hazardous area, HART transparent, OCD.

## Display example - 90 x 40mm (3.5" x 1.6")



## Ordering information

Standard configuration: F053-A-HC-OT-PX-XX-ZX.

ordering information:	F053	-	-H	-O	-P	-X	-Z
<b>Pressure input signal</b>							
A	⊗	<b>(0)4 - 20mA input.</b>					
U	⊗	0 - 10V DC input.					
<b>Panel mount enclosures - IP65 / NEMA4X</b>							
HB	⊗	Aluminum enclosure.					
HC	⊗	<b>GRP enclosure.</b>					
<b>GRP field / wall mount enclosures - IP67 / NEMA4X</b>							
HD	⊗	Cable entry: no holes.					
HE	⊗	Cable entry: 2 x Ø 16mm & 1 x Ø 20mm.					
HF	⊗	Cable entry: 1 x Ø 22mm (7/8").					
HG	⊗	Cable entry: 2 x Ø 20mm.					
HH	⊗	Cable entry: 6 x Ø 12mm.					
HJ	⊗	Cable entry: 3 x Ø 22mm (7/8").					
HK	⊗	Flat bottom, cable entry: no holes.					
<b>Aluminum field / wall mount enclosures - IP67 / NEMA4X</b>							
HA	⊗	Cable entry: 2 x PG9 + 1 x M20.					
HL	⊗	Cable entry: 2 x 1/2" NPT.					
HM	⊗	Cable entry: 2 x M16 + 1 x M20.					
HN	⊗	Cable entry: 1 x M20.					
HO	⊗	Cable entry: 2 x M20.					
HP	⊗	Cable entry: 6 x M12.					
HT	⊗	Cable entry: 1 x 1/2" NPT.					
HU	⊗	Cable entry: 3 x 1/2" NPT.					
HV	⊗	Cable entry: 4 x M20.					
HZ	⊗	Cable entry: no holes.					
<b>Digital output signal</b>							
OA		One active transistor output - requires PF or PM.					
OR		One mechanical relay output - requires PF or PM.					
OT	⊗	<b>One passive transistor output - standard configuration.</b>					
<b>Power requirements</b>							
PB		Lithium battery powered.					
PC	⊗	Lithium battery powered - Intrinsically Safe.					
PD	⊗	16 - 30V DC + sensor supply.					
PF		24V AC / DC + sensor supply.					
PL	⊗	Input loop powered from sensor signal 4 - 20mA (type A).					
PM		115 - 230V AC + sensor supply.					
PX	⊗	<b>Basic power supply 8 - 30V DC (no sensor supply).</b>					
<b>Hazardous area</b>							
XI	⊗	Intrinsically Safe, according ATEX, IECEx, CSA c-us and FM.					
XF		EExd enclosure - 3 keys.					
XX		<b>Safe area only.</b>					
<b>Other options</b>							
ZB	⊗	Backlight.					
ZX	⊗	<b>No options.</b>					

The bold marked text contains the standard configuration.

⊗ Available Intrinsically Safe.

Specifications are subject to change without notice.



Fluidwell bv  
P.O. Box 6  
5460 AA - Veghel - The Netherlands  
Telephone: +31 (0)413 343 786  
Telefax: +31 (0)413 363 443  
email: displays@fluidwell.com  
Internet: www.fluidwell.com

