

PRESSURE INDICATOR

WITH VERY LARGE DIGITS



Advantages

- Robust IP67 (NEMA4X) field enclosure. It is so rugged, **you can even stand on it!**
- Intrinsically Safe available - ATEX, IECEx, FM and CSA approval for gas and dust applications.
- Programming can be done by your own crew, with the sensible menu-driven structure, saving cost and irritation. **Know one, know them all!**
- Very diverse mounting possibilities: walls, pipes, panels or directly onto outdoor sensors!

Features

- Displays actual pressure and measuring unit.
- Very large 26mm (1") digits.
- Piegraph indication: ten segments.
- Number of digits for pressure: 5 1/2.
- Selectable on-screen engineering units: mBar - Bar - PSI.
- Explosion/flame proof $\text{Ex} \text{II} \geq \text{GD EEx d IIB T5}$.
- LED backlight option.
- Loop or battery powered, 8 - 24V AC/DC or 115 - 230V AC power supply.
- Sensor supply 8.2 / 12 / 24V DC.

Signal input

Pressure

- (0)4 - 20mA.
- 0 - 10V DC.

Applications

- The F-Series is your first and safest choice for field mount indicators. Especially in harsh weather conditions like rain, snow, salty atmospheres and temperatures between -40°C up to +80°C (-40°F up to 176°F) for safe and hazardous area applications!
- Applications where a basic pressure measurement display is required without pressure monitoring. More sophisticated models: F053, F151 and F153 or the D-Series DIN panel mount indicators.

General information

Introduction

The F050 is a straight forward pressure indicator. The measuring unit to be displayed is simply selected through an alpha-numerical configuration menu. No adhesive labels have to be put on the outside of the enclosure: a weather proof and user friendly solution!

The configuration of the Span, off-set and number of decimals is done through software functions, without any sensitive dip-switches or trimmers. A wide selection of options further enhances the capabilities of this model, including Intrinsic Safety for hazardous area applications.

Display

The display has very large 26mm (1") digits which displays the pressure and measuring unit. As the F050 has been designed for field mounted applications, a smart display update function has been incorporated. Related to the lower temperature, the update frequency of the LCD is tuned automatically to achieve a readable display even at -40°C / -40°F.

Backlight

For those applications where readability during day and night is an issue, a bi-color backlight is available. The background color green or amber and the intensity can be adjusted from the keyboard. The display is a transfective type, which means that a high contrast reading is guaranteed in full sunlight as well as during the night. This backlight option is also available Intrinsically Safe.

Configuration

All configuration settings are accessed via a simple operator menu which can be password protected. Each setting is clearly indicated with an alphanumeric description, which avoids confusing abbreviations. All settings are safely stored in EEPROM memory in the event of sudden power failure.

Signal input

The F050 does accept (0)4 - 20mA and 0 - 10V input signals from any type of pressure measurement device. Also a 4 - 20mA input loop powered model is available.

Power requirements

Several power supply options are available to power the F050 and sensor. A battery powered version with a long life lithium battery which will last up to five years. A 4-20mA input loop powered version is available as well. A real sensor supply is offered with the 24V AC/DC or 115-230V AC power requirement options.

Hazardous area

For hazardous area applications, this model has been ATEX, IECEx, FM and CSA certified Intrinsically Safe for gas and dust applications, with an allowed ambient temperature of -40°C to +70°C (-40°F to +158°F). A flame proof enclosure with ATEX certification offers the rating $\text{Ex} \text{II} \geq \text{GD EEx d IIB T5}$.

Enclosures

Various types of enclosures can be selected, all ATEX, IECEx, FM and CSA approved. As standard the F050 is supplied in an GRP panel mount enclosure, which can be converted to an IP67 / NEMA 4X GRP field mount enclosure by the addition of a back case. Most popular is our aluminum field mount enclosure with IP67 / NEMA 4X rating. Both European or U.S. cable gland entry threads are available.

Overview application F050

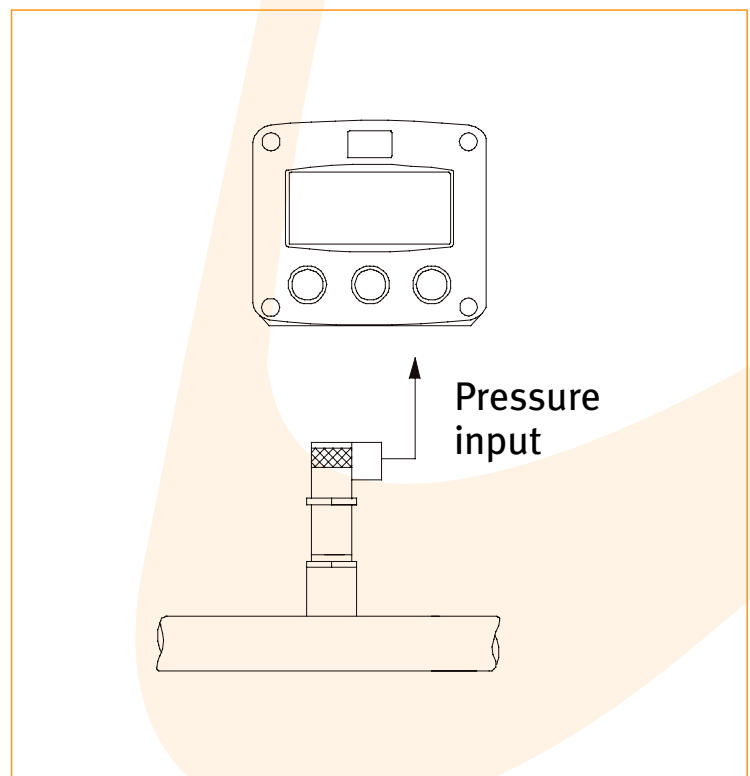

Dimensions enclosures Aluminum & GRP panel mount enclosure

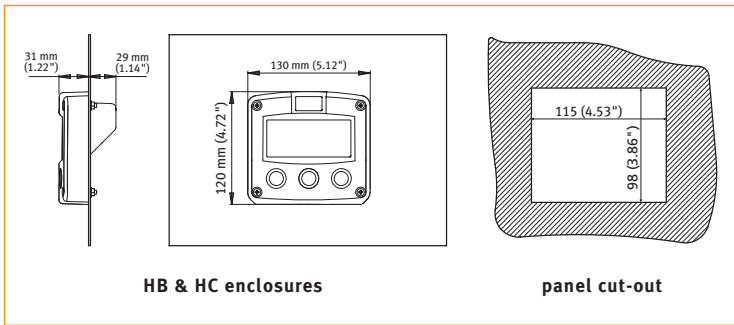

Aluminum & GRP field / wall mount enclosures

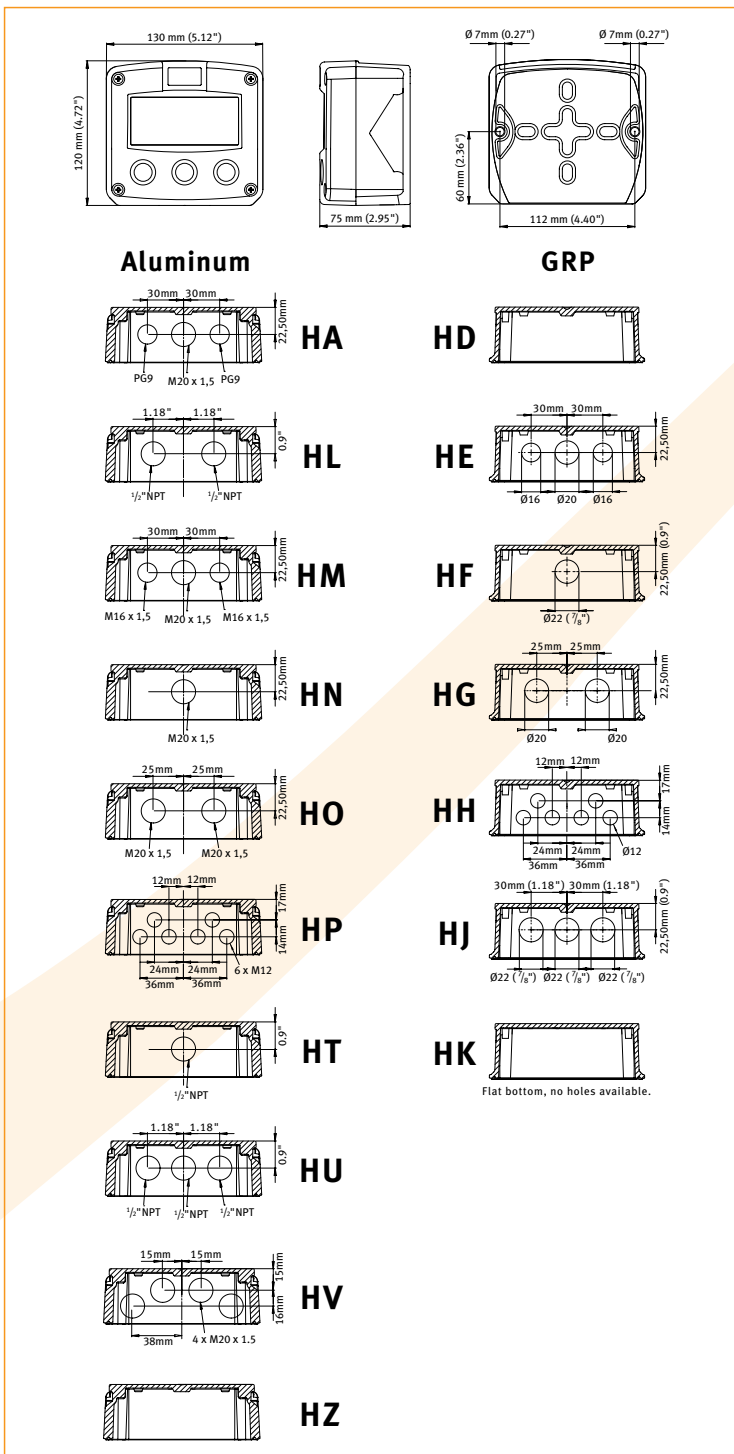

Terminal connections PB/PC - PD - PL - PX

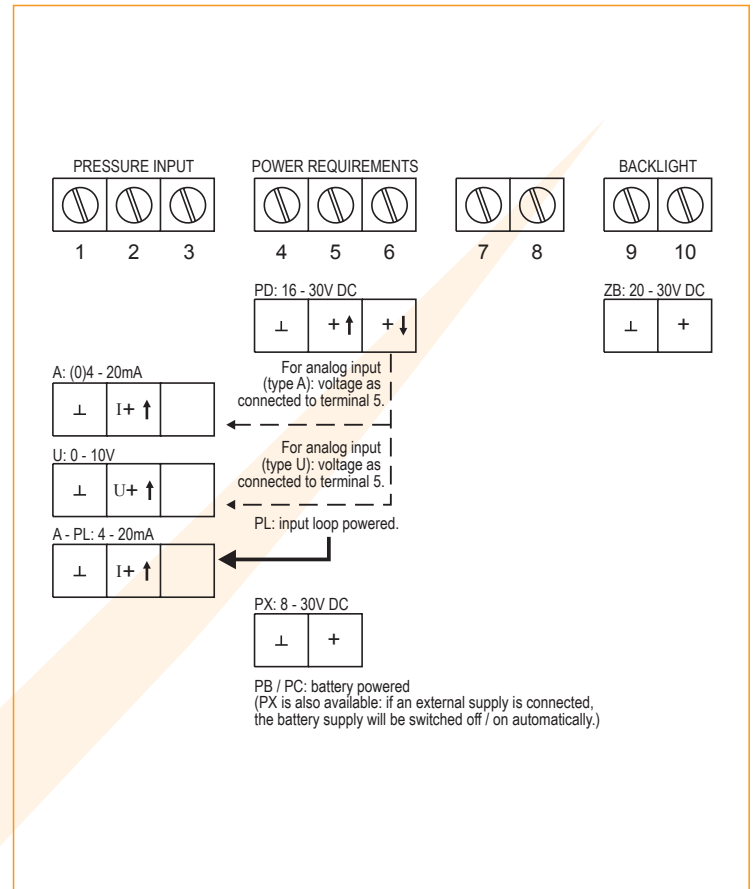

Terminal connections PF - PM

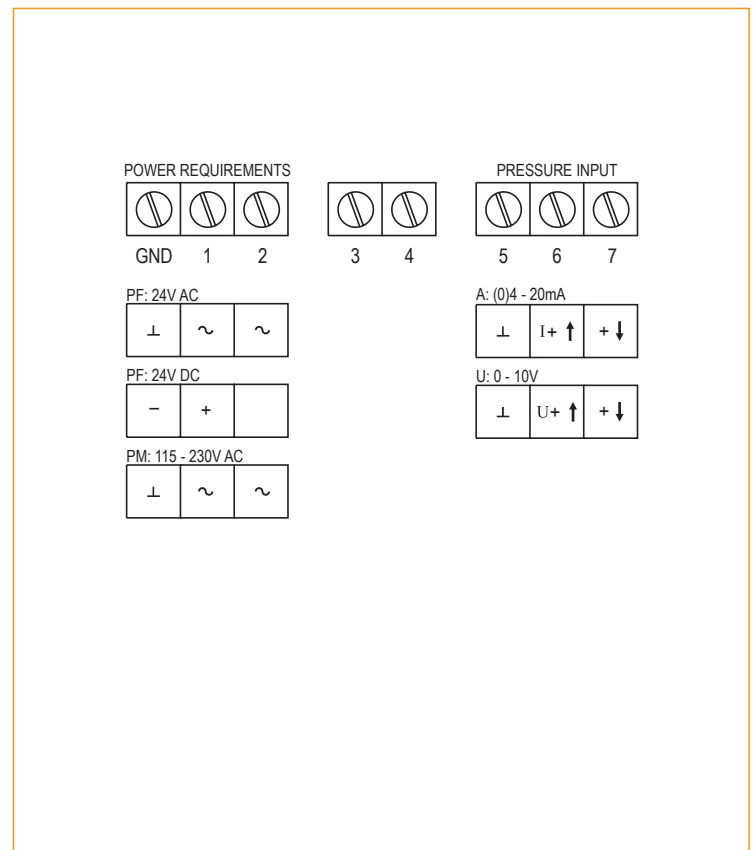

Typical wiring diagram Fo50-A-PB-(PX)

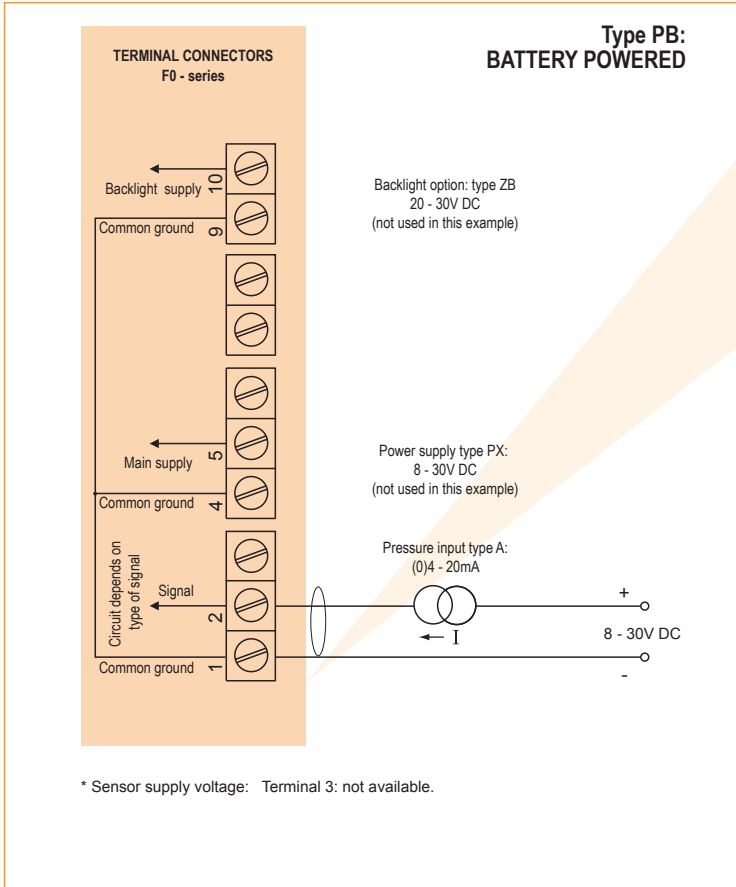

Typical wiring diagram Fo50-A-PX-ZB

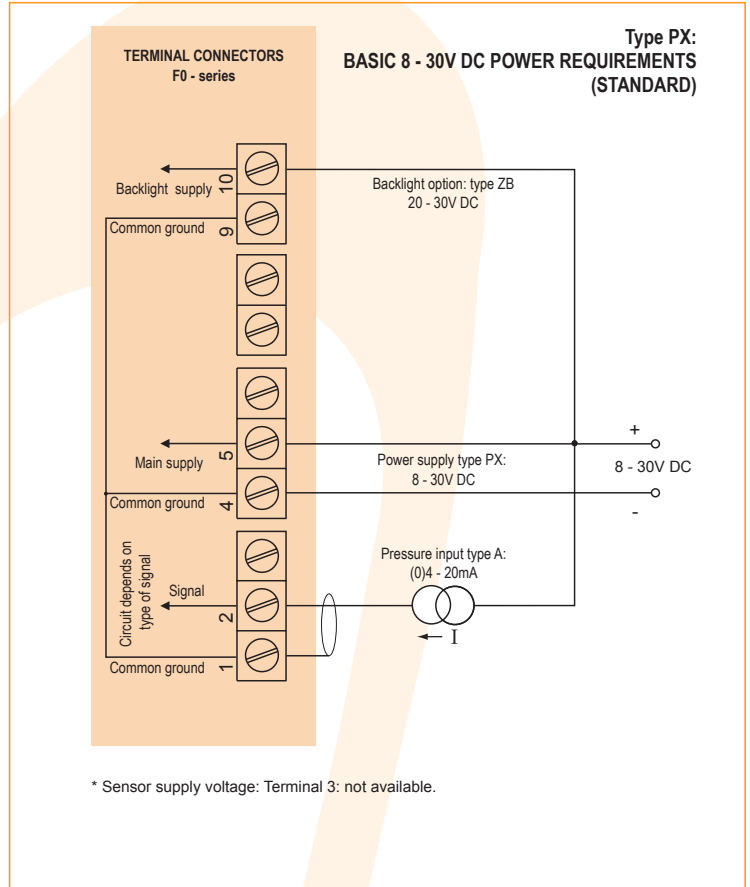

Typical wiring diagram Fo50-A-PL-ZB

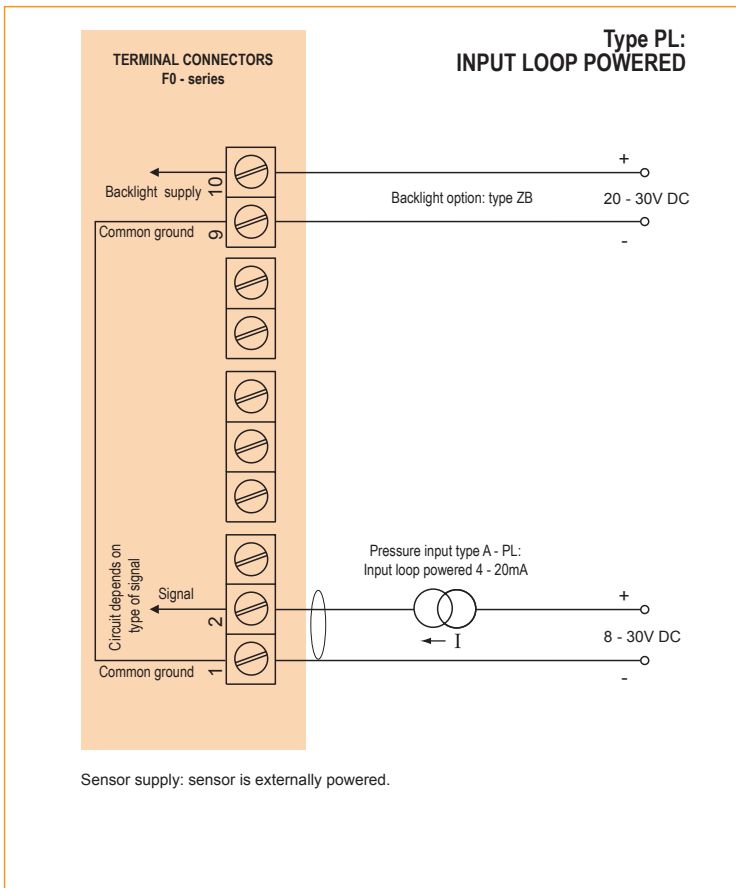

Typical wiring diagram Fo50-A-PD-ZB

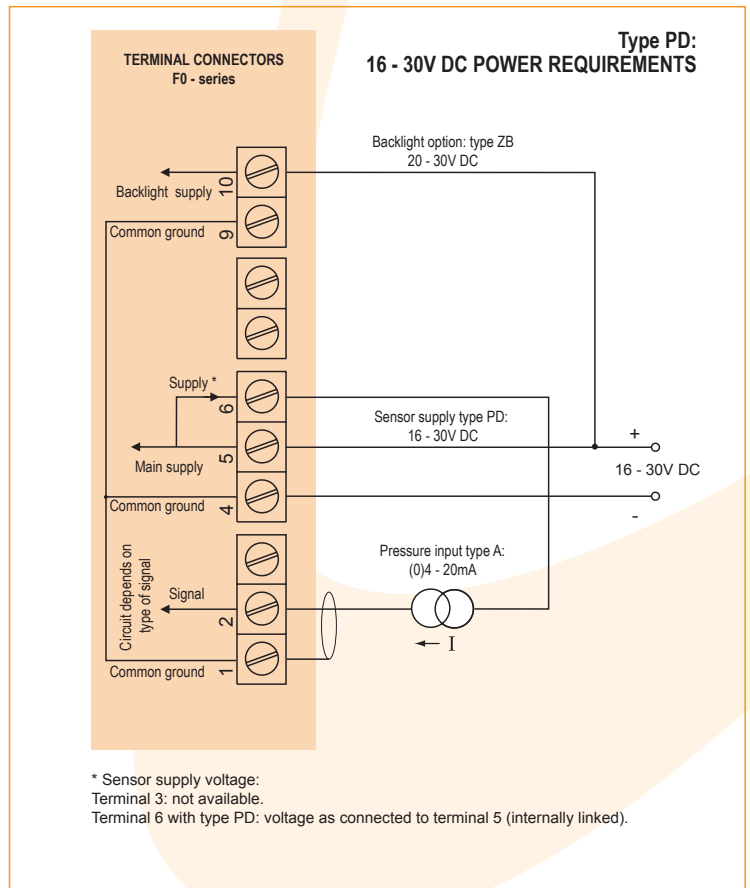

Typical wiring diagram Fo50-A-PF-ZB

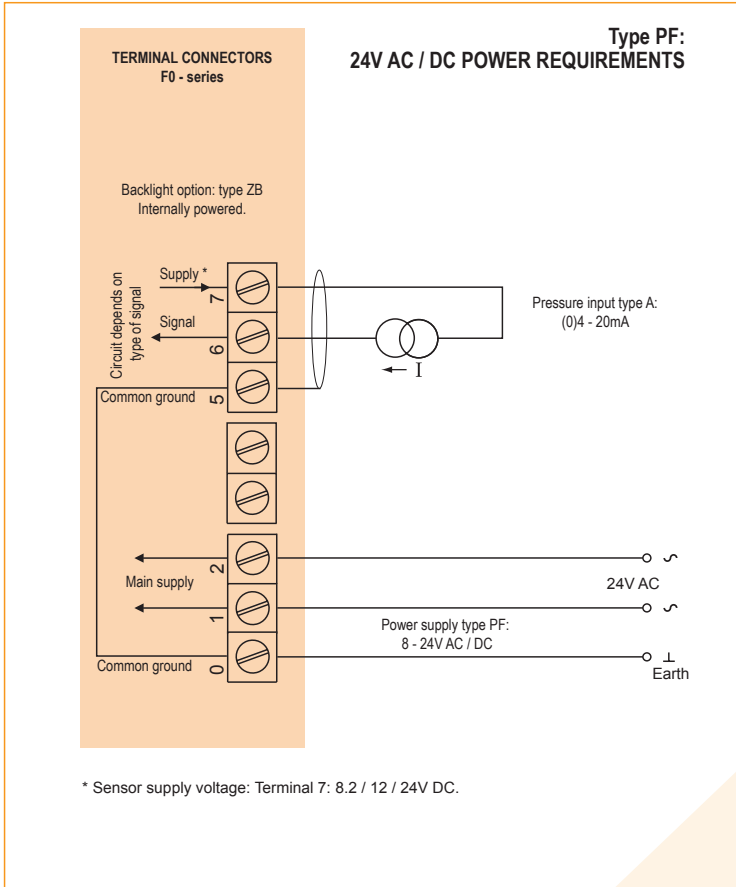

Typical wiring diagram Fo50-A-PF-ZB

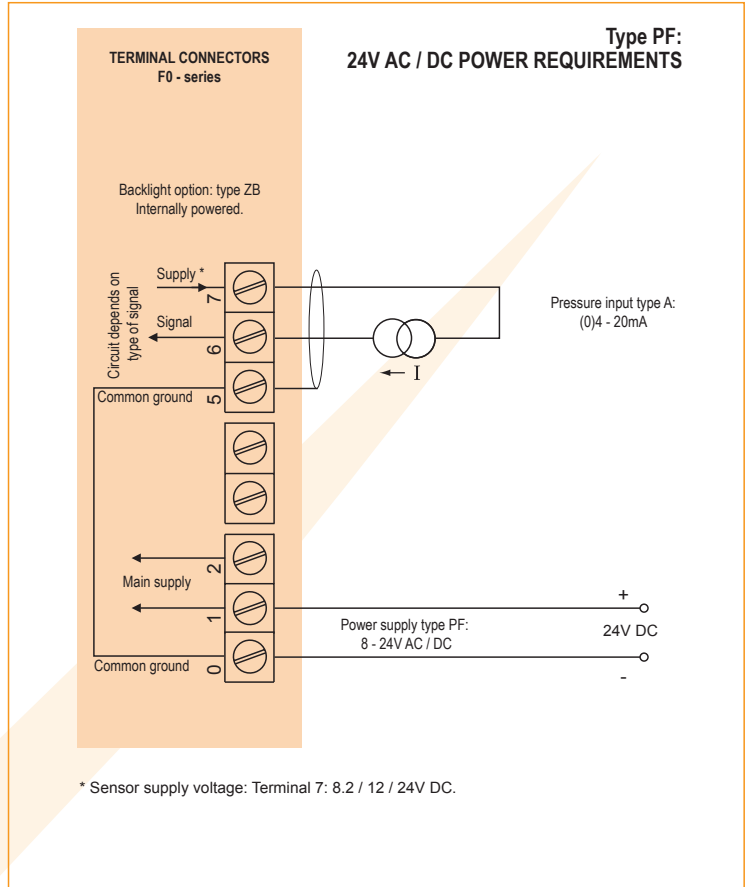

Typical wiring diagram Fo50-A-PM-ZB

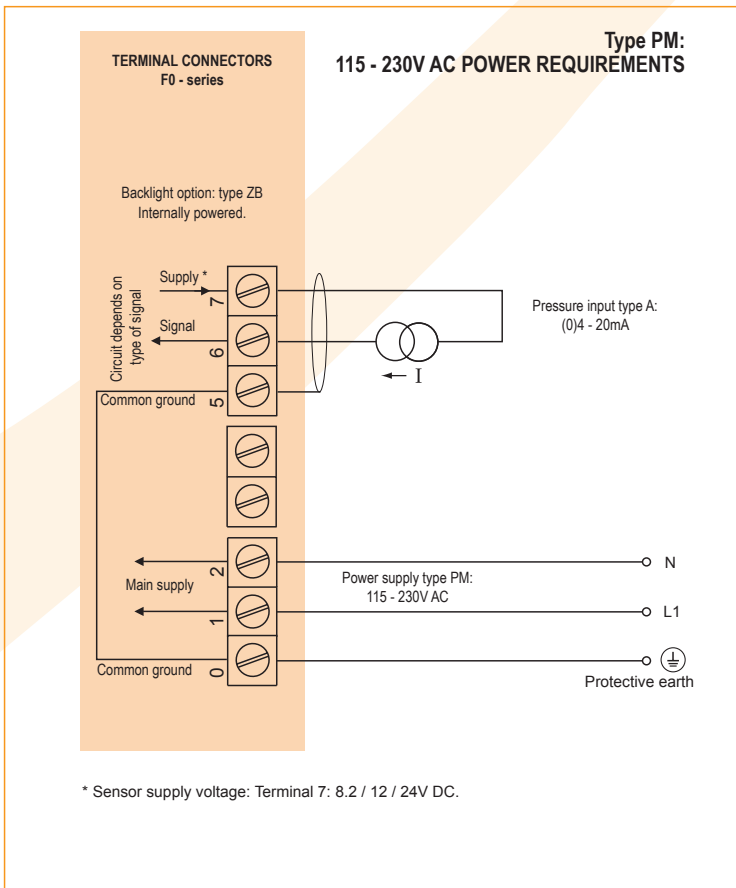

Hazardous area applications

The F050-XI has been certified according ATEX and IECEx by KEMA and according CSA c-us and FM for use in Intrinsically Safe applications with an ambient temperature of -40°C to +70°C (-40°F to +158°F).

- The ATEX markings for gas and dust applications are:

II 1 G Ex ia IIC T₄
II 1 D Ex iaD 20 IP 65/67 T 100 °C.

- The IECEx markings for gas and dust applications are: **Ga Ex ia IIC T₄** and **Ex iaD 20 IP 65/67 T100 °C.**
 - The CSA c-us markings are: **Class I/II/III, Division 1, Groups A, B, C, D, E, F, G, Temperature class T₄ and Class I, Zone o, AEx ia IIC T₄.**
 - The FM markings are: **Class I/II/III, Division 1, Groups A, B, C, D, E, F, G, Temperature class T₄ and Class I, Zone o, AEx ia IIC T₄.**
- It is allowed to connect up to three I.S. power supplies to power the unit, sensor and back-light. Consult the certificate for the maximum input and output values of the circuits.

The F050-PD-XI offers the input voltage to power an analog sensor. An ATEX approved flame proof enclosure with rating $\text{Ex} \text{ II } \geq \text{GD}$ EEx d IIB T₅ is available as well. Please contact your supplier for further details.

Certificate of conformity KEMA 05ATEX1168 X

• IECEx KEM 08.0006X • CSA.08.2059461 X

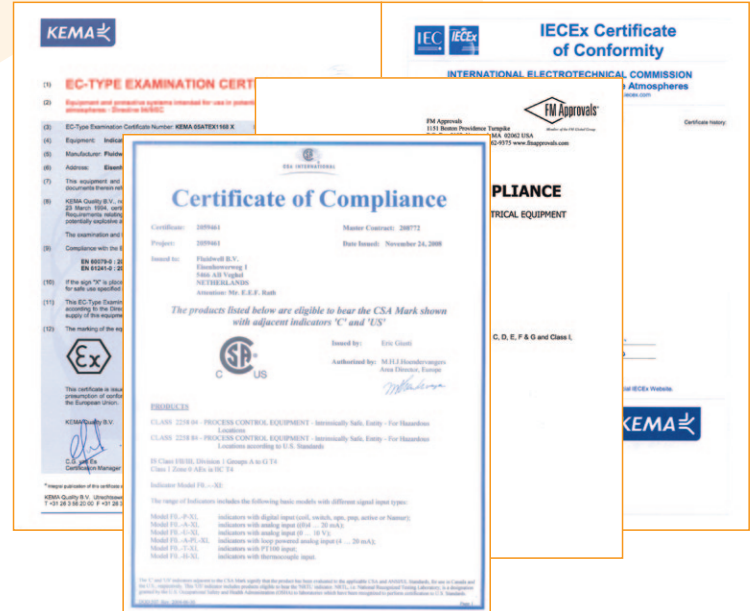

Configuration example IIA - IIB and IIC - F050-A-PX-XI-ZB - Battery powered unit

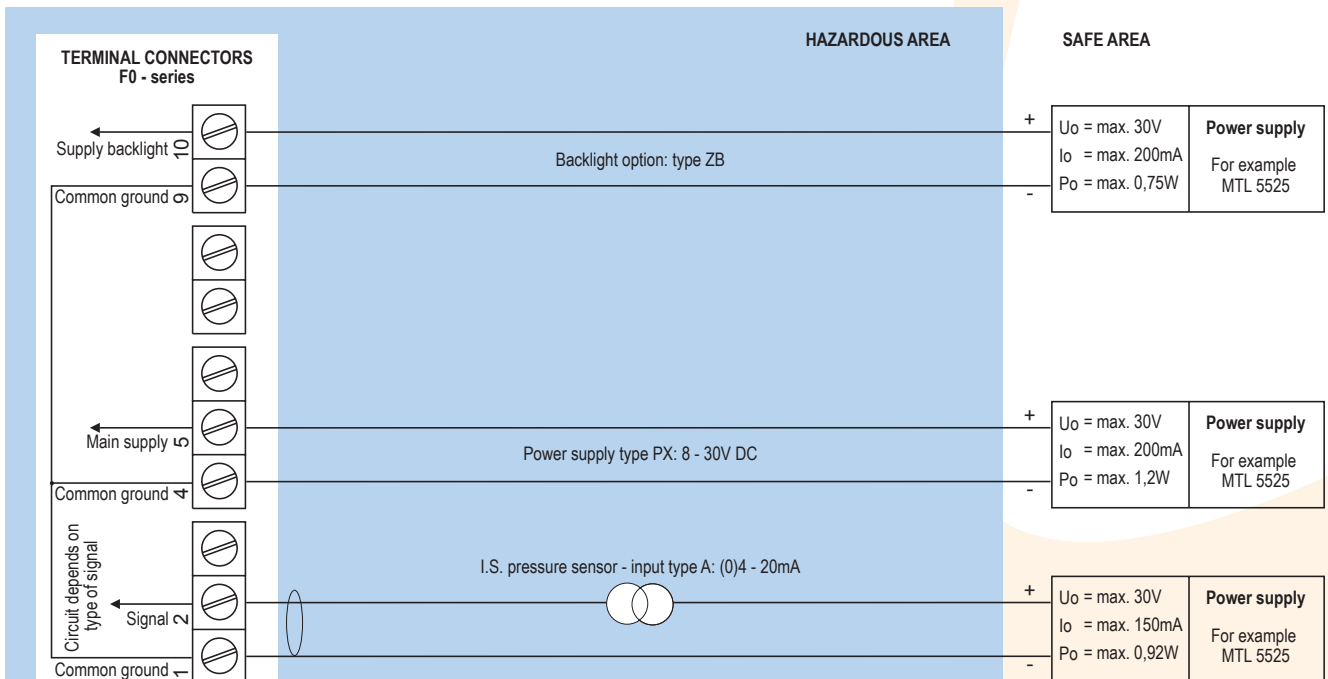

Note: above values are safety values. Consult the technical specification for operational values.

* Sensor supply voltage for analog pressure sensor type A / U: not available in this example. Please note: type PX may be used in combination with the battery (type PC). PX will power the unit; the battery will be disabled automatically till power is disconnected.

Configuration example IIA - IIB and IIC - Fo50-A-PD-XI-ZB - Power requirement 16 - 30V DC

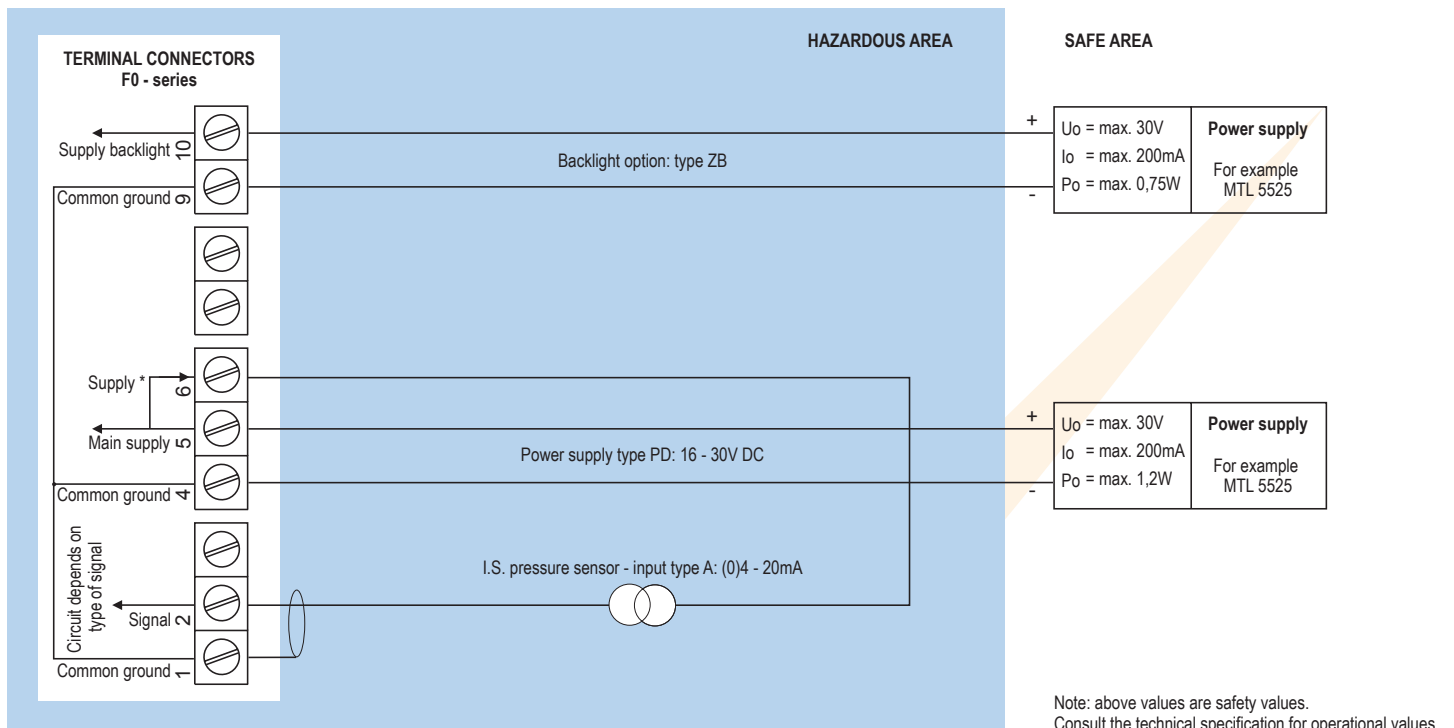

* Sensor supply voltage for analog pressure sensor type A / U; Terminal 6: as input voltage terminal 5 (internally linked).
Please note: type PD may be used in combination with the battery (type PC). PD will power the unit; the battery will be disabled automatically till power is disconnected.

Configuration example IIA - IIB and IIC - Fo50-A-PL-XI-ZB - Input loop powered

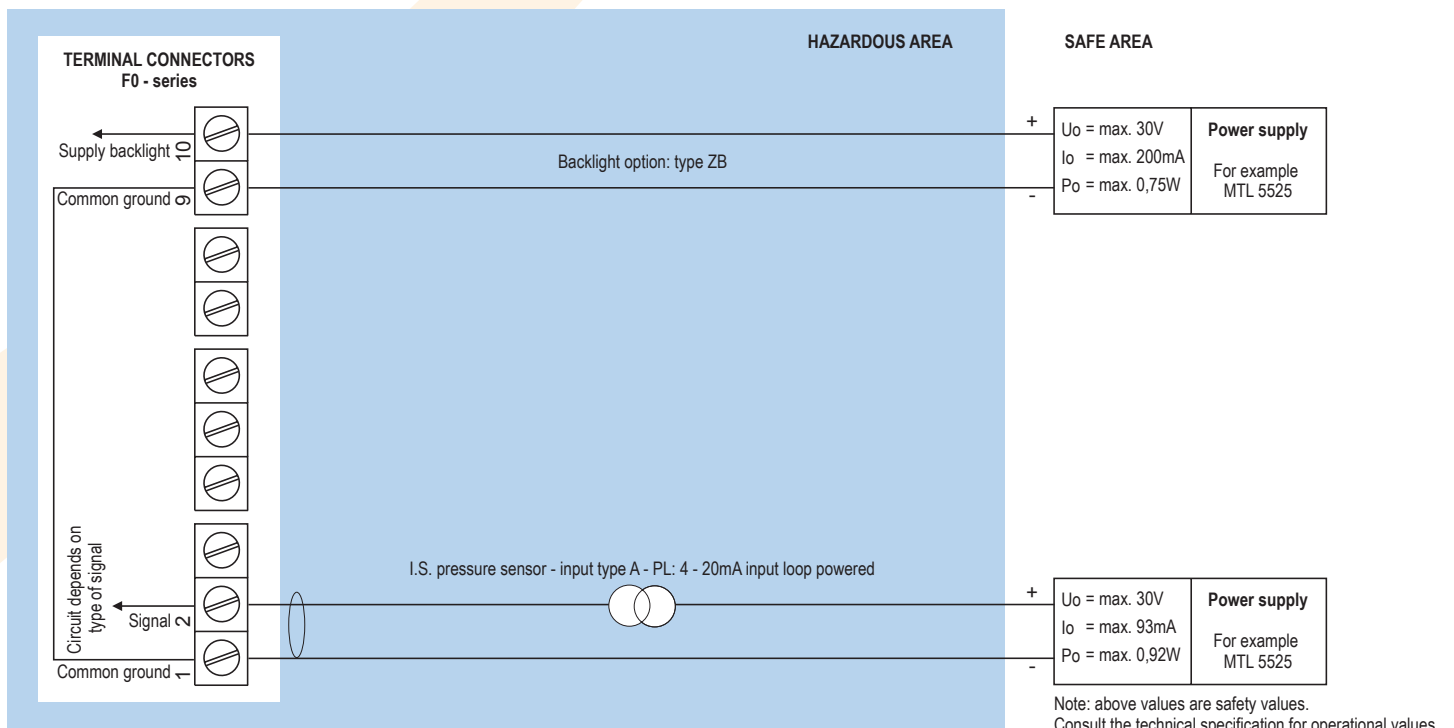

Sensor supply is not available: unit is input loop powered (type PL).
Please note: type PL may be used in combination with the battery (type PC). PL will power the unit; the battery will be disabled automatically till power is disconnected.

Technical specification

General

Display	
Type	High intensity reflective numeric and alphanumeric LCD, UV-resistant.
Dimensions	90 x 40mm (3.5" x 1.6").
Digits	5½ very large 26mm (1") digits. Various symbols and measuring units.
Piegraph	Ten segments - related to the input signal.
Refresh rate	User definable: fast, 1sec, 3sec, 15sec, 30sec, off.
Option ZB	Transflective LCD with bi-color LED-backlight; green / amber. Intensity and color selected through the keyboard. Good readings in full sunlight and darkness. Also available Intrinsically Safe.

Ambient temperature

Safe areas	-40°C to +80°C (-40°F to +176°F).
Intrinsically Safe	-40°C to +70°C (-40°F to +158°F).

Power requirements

Type PB	Long life Lithium battery - life-time depends upon settings and configuration - up to 5 years.
Type PC	Intrinsically Safe long life lithium battery - life-time depends upon settings and configuration - up to 5 years.
Type PD	16 - 30V DC. Power consumption max. 1 Watt.
Type PF	24V AC / DC ± 10%. Power consumption max. 15 Watt.
Type PL	Input loop powered from sensor signal 4 - 20mA (type A).
Type PM	115 - 230V AC ± 10%. Power consumption max. 15 Watt.
Type PX	8 - 30V DC. Power consumption max. 0.3 Watt.
Type ZB	20 - 30V DC. Power consumption max. 1 Watt. With type PF / PM: internally powered.
Note PB/PF/PM	Not available Intrinsically Safe.
Note PF/PM	The total consumption of the sensor and backlight type ZB may not exceed 400mA @ 24V DC.
Note	For Intrinsically Safe applications, consult the safety values in the certificate.

Sensor excitation

Type PB/PC/PX	Not available.
Type PD	The sensor supply voltage will be according to power supply voltage (as connected to terminal 5).
Type PF / PM	8.2 / 12 / 24V DC - max. 400mA @ 24V DC.

Terminal connections

Type	Removable plug-in terminal strip. Wire max. 1.5mm ² and 2.5mm ² .
------	--

Data protection

Type	EEPROM backup of all settings. Data retention at least 10 years.
Password	Configuration settings can be password protected.

Directives & Standards

EMC	Directive 2004/108/EC, FCC 47 CFR part 15.
Low voltage	Directive 2006/95/EC.
ATEX / IECEx	Directive 94/9/EC, IEC 60079-0, IEC 60079-11, IEC 60079-26.
FM	FM Class No. 3600, FM Class No. 3610.
CSA	CSA 22.2 No. 157-92.
IP & NEMA	EN 60529 & NEMA 250.

Enclosure

General	
Window	Polycarbonate window.
Sealing	Silicone.
Control keys	Three industrial micro-switch keys. UV-resistant silicone keypad.

Aluminum wall / field mount enclosures

General	Die-cast aluminum wall/field mount enclosure IP67 / NEMA 4X with 2-component UV-resistant coating.
Dimensions	130 x 120 x 75mm (5.12" x 4.72" x 2.95") - W x H x D.
Weight	1100 gr.
Type HA	Cable entry: 2 x PG9 and 1 x M20.
Type HL	Cable entry: 2 x ½" NPT.
Type HM	Cable entry: 2 x M16 and 1 x M20.
Type HN	Cable entry: 1 x M20.
Type HO	Cable entry: 2 x M20.
Type HP	Cable entry: 6 x M12.
Type HT	Cable entry: 1 x ½" NPT.
Type HU	Cable entry: 3 x ½" NPT.
Type HV	Cable entry: 4 x M20.
Type HZ	Cable entry: no holes.

GRP wall / field mount enclosures

General	GRP wall/field mount enclosure IP67 / NEMA 4X, UV-resistant and flame retardant.
Dimensions	130 x 120 x 75mm (5.12" x 4.72" x 2.95") - W x H x D.
Weight	600 gr.
Type HD	Cable entry: no holes.
Type HE	Cable entry: 2 x Ø 16mm and 1 x Ø 20mm.
Type HF	Cable entry: 1 x Ø 22mm (7/8").
Type HG	Cable entry: 2 x Ø 20mm.
Type HH	Cable entry: 6 x Ø 12mm.
Type HJ	Cable entry: 3 x Ø 22mm (7/8").
Type HK	Flat bottom, cable entry: no holes.

Panel mount enclosures



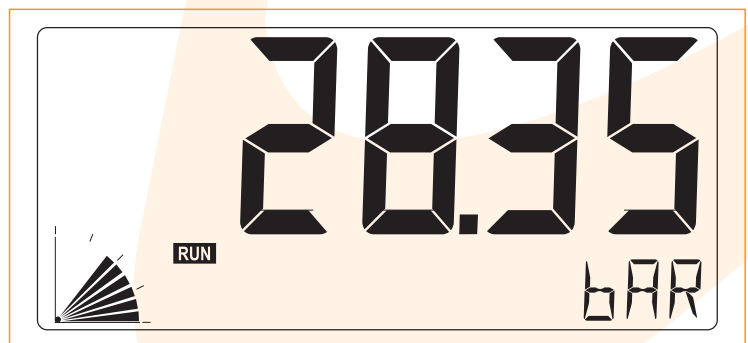

Dimensions	130 x 120 x 60mm (5.12" x 4.72" x 2.36") - W x H x D.
Panel cut-out	115 x 98mm (4.53" x 3.86") L x H.
Type HB	Die-cast aluminum panel mount enclosure IP65 / NEMA 4X.
Weight	600 gr.
Type HC	GRP panel mount enclosure IP65 / NEMA 4X, UV-resistant and flame retardant.
Weight	450 gr.

Display example - 90 x 40mm (3.5" x 1.6")



Hazardous area

Intrinsically Safe

ATEX certification	 II 1 G Ex ia IIC T4. II 1 D Ex iaD 20 IP 65 / 67 T 100 °C.
IECEX certification	 Ga Ex ia IIC T4. Ex iaD 20 IP 65 / 67 T 100 °C.
CSA c-us certification	 Intrinsically Safe for Class I/II/III, Div. 1, Groups A, B, C, D, E, F, G, Temp. class T4 and Class I, Zone o, AEx ia IIC T4.
FM certification	 Intrinsically Safe for Class I/II/III, Div. 1, Groups A, B, C, D, E, F, G, Temp. class T4 and Class I, Zone o, AEx ia IIC T4.
Ambient Ta	-40°C to +70°C (-40°F to +158°F).

Explosion proof

ATEX certification	 II 2 GD EEx d IIB T5.
Type XF	Dimensions of enclosure: 300 x 250 x 200mm (11.8" x 9.9" x 7.9") L x H x D.
Weight	Appr. 15kg.

Signal input

Pressure sensor

Type A	(0)4 - 20mA. Analog input signal can be scaled to any desired range within 0 - 20mA.
Type U	0 - 10V DC. Analog input signal can be scaled to any desired range within 0 - 10V DC.
Accuracy	Resolution: 16 bit. Error < 0.01mA / ± 0.05% FS. Low level cut-off programmable.
Span	0.00001 / 199,999 with variable decimal position.
Offset	-99,999 / +199,999 units.
Update time	Four times per second.
Voltage drop	Type A: max. 1V DC @ 20mA.
Voltage drop	Type A - PL (loop powered): max. 2.6V DC @ 20mA.
Load impedance	Type U: 3kOhm.
Relationship	Linear and square root calculation.
Note	For signal type A and U: external power to sensor is required; e.g. type PD.

Operational

Operator functions

Displayed functions	<ul style="list-style-type: none"> Actual pressure. Measuring unit.
---------------------	---

Pressure

Digits	5 ¹ / ₂ digits.
Units	mbar, bar, PSI, no-unit.
Decimals	0 - 1 - 2 - 3 - 4 or 5.

Accessories

Mounting accessories

ACFo2	Stainless steel wall mounting kit.
ACFo5	Stainless steel pipe mounting kit (worm gear clamps not included).
ACFo6	Two stainless steel worm gear clamps Ø 44 - 56mm.
ACFo7	Two stainless steel worm gear clamps Ø 58 - 75mm.
ACFo8	Two stainless steel worm gear clamps Ø 77 - 95mm.
ACFo9	Two stainless steel worm gear clamps Ø 106 - 138mm.
ACF10	Customized Grevopal tagplates for ACFo2 and ACFo5, including stainless steel screws. Dimension: 95mm x 12.5mm (3.75" x 0.50").

Cable glands

ACF20	For HA enclosure, includes O-rings.
ACF25	For HE enclosure, includes locknuts and O-rings.
ACF26	For HF enclosure, includes locknuts and O-rings.
ACF27	For HG enclosure, includes locknuts and O-rings.
ACF28	For HH enclosure, includes locknuts and O-rings.
ACF29	For HJ enclosure, includes locknuts and O-rings.
ACF32	For HM enclosure, includes O-rings.
ACF33	For HN enclosure, includes O-rings.
ACF34	For HO enclosure, includes O-rings.
ACF35	For HP enclosure, includes O-rings.
ACF39	For HT enclosure, includes O-rings.
ACF40	For HU enclosure, includes O-rings.

Blind plugs

ACF50	For HA enclosure, includes O-rings.
ACF55	For HE enclosure, includes locknuts and O-rings.
ACF56	For HF enclosure, includes locknuts and O-rings.
ACF57	For HG enclosure, includes locknuts and O-rings.
ACF58	For HH enclosure, includes locknuts and O-rings.
ACF59	For HJ enclosure, includes locknuts and O-rings.
ACF62	For HM enclosure, includes O-rings.
ACF63	For HN enclosure, includes O-rings.
ACF64	For HO enclosure, includes O-rings.
ACF65	For HP enclosure, includes O-rings.
ACF69	For HT enclosure, includes O-rings.
ACF70	For HU enclosure, includes O-rings.

Intrinsically Safe isolators

ACGo1	MTL5511 - One channel pulse or switch output transfer from hazardous area to safe area.
ACGo2	MTL5525 - One channel power supply from safe area to hazardous area (e.g. to power the unit with PD or to power a switching or analog device in hazardous area).
ACGo3	MTL5541 - One channel 4 - 20mA repeater from hazardous area to safe area.
ACGo4	MTL 5051 - Bi-direction serial-data-isolator (for Modbus communication).
ACGo5	MTL5516C - Two channel pulse or switch output transfer from hazardous area to safe area.
ACGo6	MTL5513 - One channel pulse or switch output transfer from hazardous area to safe area.
ACGo7	MTL5546Y - One channel isolated driver bringing 4 - 20mA from safe area to hazardous area, HART transparent, OCD.

Ordering information

Standard configuration: F050-A-HC-PX-XX-ZX.

ordering information:	F050	-	-H	-P	-X	-Z
Pressure input signal						
A	⊗ (o)4 - 20mA input.					
U	⊗ 0 - 10V DC input.					
Panel mount enclosures - IP65 / NEMA4X						
HB	⊗ Aluminum enclosure.					
HC	⊗ GRP enclosure.					
GRP field / wall mount enclosures - IP67 / NEMA4X						
HD	⊗ Cable entry: no holes.					
HE	⊗ Cable entry: 2 x Ø 16mm & 1 x Ø 20mm.					
HF	⊗ Cable entry: 1 x Ø 22mm (7/8").					
HG	⊗ Cable entry: 2 x Ø 20mm.					
HH	⊗ Cable entry: 6 x Ø 12mm.					
HJ	⊗ Cable entry: 3 x Ø 22mm (7/8").					
HK	⊗ Flat bottom, cable entry: no holes.					
Aluminum field / wall mount enclosures - IP67 / NEMA4X						
HA	⊗ Cable entry: 2 x PG9 + 1 x M20.					
HL	⊗ Cable entry: 2 x 1/2" NPT.					
HM	⊗ Cable entry: 2 x M16 + 1 x M20.					
HN	⊗ Cable entry: 1 x M20.					
HO	⊗ Cable entry: 2 x M20.					
HP	⊗ Cable entry: 6 x M12.					
HT	⊗ Cable entry: 1 x 1/2" NPT.					
HU	⊗ Cable entry: 3 x 1/2" NPT.					
HV	⊗ Cable entry: 4 x M20.					
HZ	⊗ Cable entry: no holes.					
Power requirements						
PB	Lithium battery powered.					
PC	⊗ Lithium battery powered - Intrinsically Safe.					
PD	⊗ 16 - 30V DC + sensor supply.					
PF	24V AC / DC + sensor supply.					
PL	⊗ Input loop powered from sensor signal 4 - 20mA (type A).					
PM	115 - 230V AC + sensor supply.					
PX	⊗ Basic power supply 8 - 30V DC (no sensor supply).					
Hazardous area						
XI	⊗ Intrinsically Safe, according ATEX, IECEx, CSA c-us and FM.					
XF	EExd enclosure - 3 keys.					
XX	Safe area only.					
Other options						
ZB	⊗ Backlight.					
ZX	⊗ No options.					

The bold marked text contains the standard configuration.

⊗ Available Intrinsically Safe.

Specifications are subject to change without notice.



Fluidwell bv
P.O. Box 6
5460 AA - Veghel - The Netherlands
Telephone: +31 (0)413 343 786
Telefax: +31 (0)413 363 443
email: displays@fluidwell.com
Internet: www.fluidwell.com

