

Type 2730, 2731, 2731 K DN 15 - 50

Piston controlled diaphragm control valve
Kolbengesteuertes Membranregelventil
Vanne de réglage à membrane commandée par piston



Operating Instructions

Bedienungsanleitung
Manuel d'utilisation

We reserve the right to make technical changes without notice.
Technische Änderungen vorbehalten.
Sous réserve de modifications techniques.

© Bürkert Werke GmbH & Co. KG, 200€ - 2017

Operating Instructions 1706/FÍ_EU-EN_008€HJ€Í / Original DE

1 OPERATING INSTRUCTIONS	4	7.2 Installation.....	19
1.1 Definition of term “device”.....	4	7.3 Pneumatic connection.....	20
1.2 Symbols.....	4	8 REMOVAL	21
2 AUTHORIZED USE	5	9 ELECTRICAL CONTROL UNIT	21
3 BASIC SAFETY INSTRUCTIONS	5	10 MALFUNCTIONS	22
4 GENERAL INFORMATION	6	11 MAINTENANCE	22
4.1 Contact address.....	6	11.1 Maintenance and cleaning.....	22
4.2 Warranty.....	6	11.2 Replacing the diaphragm.....	24
4.3 Information on the internet.....	6	12 REPLACEMENT PARTS	26
5 PRODUCT DESCRIPTION	7	12.1 Order table.....	27
5.1 General description.....	7	13 PACKAGING, TRANSPORT, STORAGE	28
5.2 Properties.....	7		
5.3 Structure and function.....	7		
6 TECHNICAL DATA	8		
6.1 Conformity.....	8		
6.2 Standards.....	8		
6.3 Type label.....	8		
6.4 Labeling of the forged bodies.....	9		
6.5 Labeling of the tube valve body (VP).....	9		
6.6 Operating conditions.....	10		
6.7 Flow values and characteristics.....	16		
6.8 General technical data.....	16		
7 INSTALLATION	17		
7.1 Before installation.....	17		

1 OPERATING INSTRUCTIONS

The operating instructions describe the entire life cycle of the device. Keep these instructions in a location which is easily accessible to every user and make these instructions available to every new owner of the device.

Important safety information.

Failure to observe these instructions may result in hazardous situations.

- ▶ The operating instructions must be read and understood.

1.1 Definition of term “device”

The term “device” used in these instructions always stands for the diaphragm control valve Type 2730, 2731 and 2731 K.

1.2 Symbols



DANGER!

Warns of an immediate danger.

- ▶ Failure to observe the warning may result in a fatal or serious injury.



WARNING!

Warns of a potentially dangerous situation.

- ▶ Failure to observe the warning may result in serious injuries or death.



CAUTION!

Warns of a possible danger.

- ▶ Failure to observe this warning may result in a moderately severe or minor injury.

NOTE!

Warns of damage to property.



Important additional information, tips and recommendations.



Refers to information in these operating instructions or in other documentation.

- ▶ designates instructions for risk prevention.

→ designates a procedure which you must carry out.

2 AUTHORIZED USE

Non-authorized use of the diaphragm control valve Type 2730, 2731 and 2731 K may be a hazard to people, nearby equipment and the environment.

- ▶ The device is designed for the controlled flow of liquid media.
- ▶ In the potentially explosion-risk area Type 2730, 2731 and 2731 K may be used only according to the specification on the separate Ex type label. For use observe the additional information enclosed with the device together with safety instructions for the explosion-risk area.
- ▶ Devices without a separate Ex type label may not be used in a potentially explosive area.
- ▶ The admissible data, the operating conditions and conditions of use specified in the contract documents, operating instructions and on the label are to be observed during use. The designated application cases are specified in the chapter entitled "[5 Product description](#)".
- ▶ The device may be used only in conjunction with third-party devices and components recommended and authorised by Bürkert.
- ▶ Correct transportation, correct storage and installation and careful use and maintenance are essential for reliable and faultless operation.
- ▶ Use the device only as intended.

3 BASIC SAFETY INSTRUCTIONS

These safety instructions do not make allowance for any

- contingencies and events which may arise during the installation, operation and maintenance of the devices.
- local safety regulations, whereby the operator is responsible for their compliance, by the installation personnel too.



DANGER!

Danger – high pressure.

- ▶ Before dismantling the lines and valves, turn off the pressure and vent the lines.

Risk of electric shock.

- ▶ Before reaching into the device, switch off the power supply and secure to prevent reactivation.
- ▶ Observe applicable accident prevention and safety regulations for electrical equipment.

Risk of injury when opening the actuator.

The actuator contains a tensioned spring. If the actuator is opened, there is a risk of injury from the spring jumping out!

- ▶ The actuator must not be opened.

Risk of burns.

The surface of the device may become hot during long-term operation.

- ▶ Do not touch the device with bare hands.

General hazardous situations.

To prevent injury, ensure that:

- ▶ The system cannot be activated unintentionally.
- ▶ Installation and repair work may be carried out by authorized technicians only and with the appropriate tools.
- ▶ After an interruption in the power supply or pneumatic supply, ensure that the process is restarted in a defined or controlled manner.
- ▶ The device may be operated only when in perfect condition and in consideration of the operating instructions.
- ▶ The general rules of technology apply to application planning and operation of the device.

To prevent damage to property on the device, ensure:

- ▶ Supply the media connections only with those media which are specified as flow media in the chapter entitled "[6 Technical data](#)".
- ▶ Do not put any loads on the valve (e.g. by placing objects on it or standing on it).
- ▶ Do not make any external modifications to the valves. Do not paint the body parts or screws.

4 GENERAL INFORMATION

4.1 Contact address

Germany

Bürkert Fluid Control Systems
Sales Center
Christian-Bürkert-Str. 13-17
D-74653 Ingelfingen
Tel.: + 49 (0)7940 - 10 91 111
Fax: + 49 (0)7940 - 10 91 448
E-mail: info@de.burkert.com

International

Contact addresses are found on the final pages of the printed operating manual.

You can also find information on the Internet under:

www.burkert.com

4.2 Warranty

The warranty is only valid if the device is used as authorized in accordance with the specified application conditions.

4.3 Information on the internet

The operating instructions and data sheets for Type 2730, 2731 and 2731 K can be found on the Internet at: www.burkert.com

5 PRODUCT DESCRIPTION

5.1 General description

The piston-controlled diaphragm control valve Type 2730, 2731 and 2731K is suitable for liquid media. Using neutral gases or air (control media), it controls the flow of dirty, aggressive, ultrapure or sterile media, even highly viscous media can be used (flow media). The operation of the diaphragm control valve Type 2730, 2731 and 2731K is possible only in combination with a control unit.

5.2 Properties

- Any flow direction.
- Self-draining for appropriate installation. The ends of the utilized connections must be cylindrical.
- Free of empty space.
- Low-turbulence flow.
- High flow values by the streamlined valve body.
- Maintenance-free under normal conditions.

5.2.1 Actuator sizes

The piston-controlled diaphragm control valve is available for the following actuator sizes: ø 80 mm, ø 100 mm, ø 125 mm.

5.2.2 Pilot pressure

Designs with lower pilot pressure (reduced spring force) are available on request.

5.3 Structure and function



The operation of the diaphragm control valve Type 2730, 2731 and 2731 K is possible only in combination with a control unit.

Possible control units are:

Positioner Type 8635, 8692, 8694, 8792

Process controller Type 8693, 8793

5.3.1 Structure

The piston-controlled diaphragm control valve consists of a pneumatically operated piston actuator and a 2/2-way valve body.

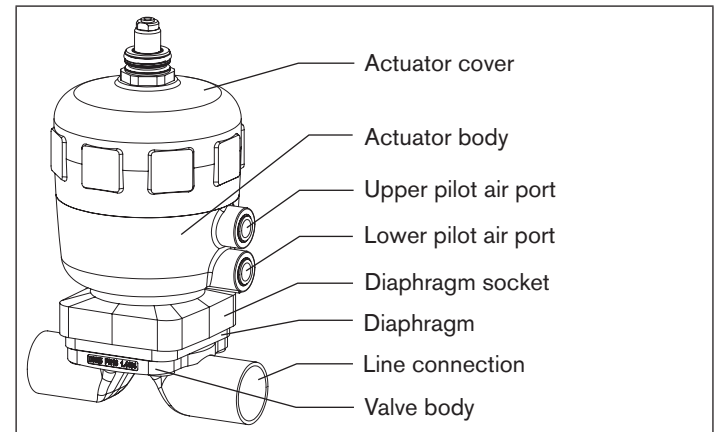

Fig. 1: Structure and description

5.3.2 Function

Spring force (CFA) or pneumatic pilot pressure (CFB) generates the closing force on the diaphragm pressure piece. The force is transferred via a spindle which is connected to the actuator piston.

Control function A (CFA)

Normally closed by spring action

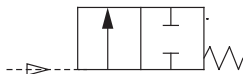

Control function B (CFB)

Normally open by spring action

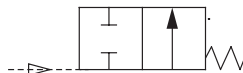

6 TECHNICAL DATA

6.1 Conformity

In accordance with the EU Declaration of conformity, the diaphragm control valve Type 2730, 2731 and 2731 K is compliant with the EU Directives.

6.2 Standards

The applied standards, which verify conformity with the EU Directives, can be found on the EU-Type Examination Certificate and / or the EU Declaration of Conformity.

6.3 Type label

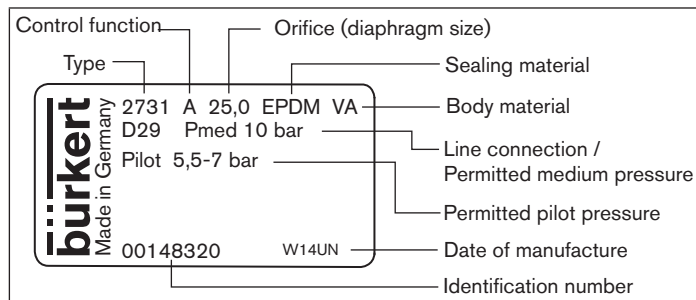

Fig. 2: Type label (example)

6.4 Labeling of the forged bodies

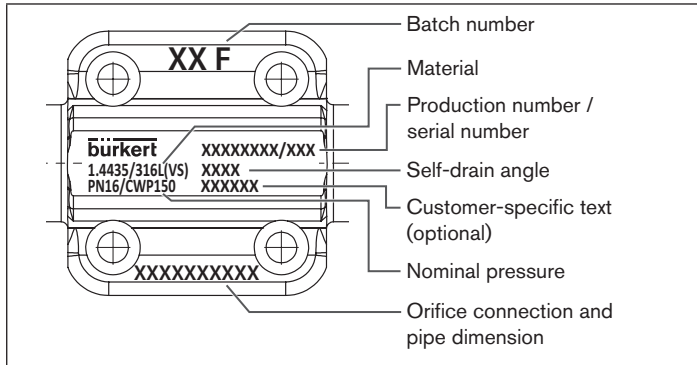

Fig. 3: Labeling of the forged bodies

6.5 Labeling of the tube valve body (VP)

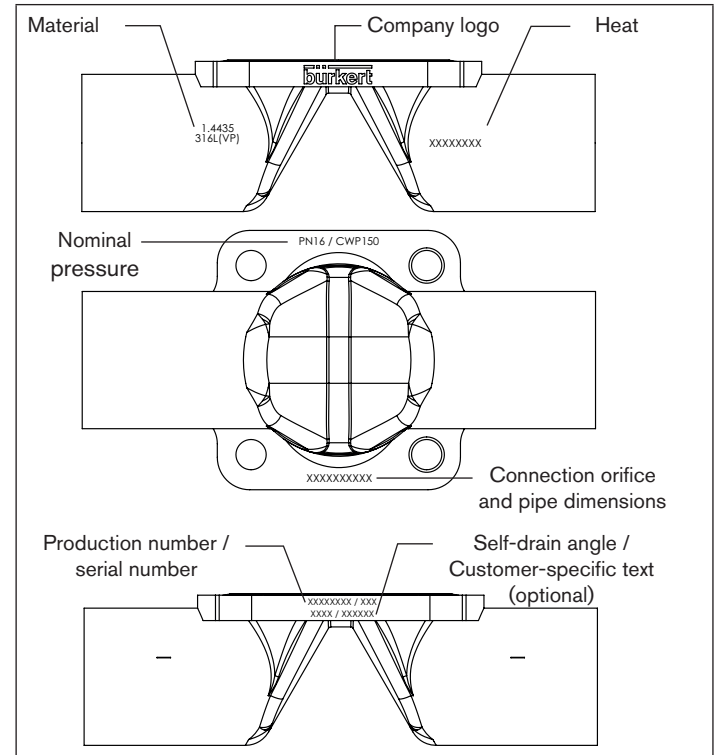

Fig. 4: Labeling of the tube valve body (VP)

6.6 Operating conditions



WARNING!

Risk of injury, chemical burns, scalding due to the device rupturing at excessively high pressure.

- ▶ Do not exceed the maximum pilot and medium pressure.
- ▶ Observe permitted ambient and medium temperature.
- ▶ Observe specifications on the type label.

6.6.1 Temperature ranges

Permitted ambient temperature actuators

Actuator size	Actuator material	Ambient temperature ¹⁾
ø 80 mm	PA, PPS	-10 – +60 °C
ø 100 mm		
ø 125 mm		

Tab. 1: Permitted ambient temperature actuators



¹⁾ If using a pilot valve / control unit, observe its temperature range.

Permitted medium temperature for body



Plastic body: note that the permissible medium pressure is dependent on the medium temperature (see [“Fig. 5: Graph of medium pressure / medium temperature”](#)).

Body material		Medium
PVDF (PD)		-10 – +120 °C
PP (PP)		-10 – +80 °C
PVC (PV)		-10 – +60 °C
Tube valve body (VP)	1.4404 (AISI 316L)	-10 – +150 °C
Cast body (VG)	1.4435 (AISI 316L)	
Forged body (VS)	1.4435 BN2 (AISI 316L) according to ASME BPE 1997	

Tab. 2: Permitted medium temperature for body

Permitted medium temperature for diaphragms



The indicated medium temperatures apply only to media which do not corrode or swell the diaphragm materials.

The behavior of the medium with respect to the diaphragm may be changed by the medium temperature.

The function properties, in particular the service life of the diaphragm, may deteriorate if the medium temperature increases.

Do not use the diaphragms as steam shut-off element.

Material	Temperature	Remarks
EPDM (AB)	-10...+130 °C	Steam sterilisation up to +140 °C / 60 min
EPDM (AD)	-5...+143 °C	Steam sterilisation up to +150 °C / 60 min
FKM (FF)	0...+130 °C	No steam / dry heat up to +150 °C / 60 min
PTFE (EA)	-10...+130 °C	Steam sterilisation up to +140 °C / 60 min

Material	Temperature	Remarks
Advanced PTFE (EU)	-5...+143 °C	Steam sterilisation up to +150 °C / 60 min
Advanced PTFE (ET)	-10...+90 °C	-
Gylon (ER)	-5...+130 °C	Steam sterilisation up to +140 °C / 60 min

Tab. 3: Permitted medium temperature for diaphragms

6.6.2 Pressure ranges

Pilot pressure for valves with pneumatic position controller

 To ensure reliable operation with pneumatic position controller, observe the permitted minimum and maximum pilot pressure!

Actuator size [mm]	Pilot pressure
ø 80, ø 100, ø 125	5.5 – 7.0 bar

Tab. 4: Pilot pressure for valves with pneumatic position controller

Maximum pilot pressure for valves without pneumatic position controller

Actuator size [mm]	Actuator material	Max. permitted pilot pressure ²⁾
ø 80, ø 100	PA	10 bar
ø 125	PA	7 bar
ø 80, ø 100, ø 125	PPS	7 bar

Tab. 5: Pilot pressure for valves without pneumatic position controller

Maximum pilot pressure for valves without pneumatic position controller - only control function B and tube valve body (VP)

Actuator size [mm]	Actuator material	Max. permitted pilot pressure ²⁾
ø 80, ø 100, ø 125	PA, PPS	6 bar

Tab. 6: Maximum pilot pressure for valves without pneumatic position controller - only CFB and tube valve body (VP)

 ²⁾ Observe the maximum pressure range according to the type label!

Medium pressure for plastic body

 Plastic body: note that the permissible medium pressure is dependent on the medium temperature (see "Fig. 5").

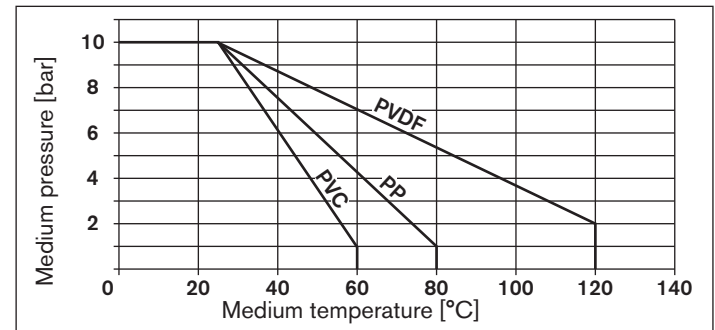

Fig. 5: Graph of medium pressure / medium temperature

Operating pressure for control function A³⁾

The values apply to

- Plastic body PVDF (PD), PP (PP), PVC (PV)
- Forged steel body (VS)
- Precision casting body (VG)
- Tube valve body (VP) with
 - ISO weld end connection
 - ISO clamp connection
 - Threaded connection
 - Welded neck flange

Actuator size [mm]	Orifice DN (Diaphragm size) [mm]	Max. sealed medium pressure [bar]			
		Pressure on one side		Pressure on both sides	
		EPDM/FKM	PTFE	EPDM/FKM	PTFE
ø 80	15	10	10	10	10
	20	10	10	10	10
	25	10	7.5	8.5	5.5
ø 100	32	10	8	9	6
ø 125	40	10	10	10	9
	50	8	7	7	6

Tab. 7: Operating pressure for control function A

Operating pressure for control function A³⁾

The values apply to

- Tube valve body (VP) with
 - DIN weld end connection
 - DIN clamp connection

Actuator size [mm]	Orifice DN (Diaphragm size) [mm]	Max. sealed medium pressure [bar]			
		Pressure on one side		Pressure on both sides	
		EPDM/FKM	PTFE	EPDM/FKM	PTFE
ø 80	15	10	10	10	10
	20	10	10	10	10
	25	10	10	10	9
	32	10	8	7.5	6
ø 100	40	10	8	8	6
ø 125	50	10	10	10	8.5

Tab. 8: Operating pressure for control function A

³⁾ The control functions are described in the chapter entitled "[5.3.2 Function](#)".

Operating pressure for control function A³⁾

The values apply to

- Tube valve body (VP) with OD weld end connection
BS clamp connection

Actuator size [mm]	Orifice DN (Diaphragm size) [mm]	Max. sealed medium pressure [bar]			
		Pressure on one side		Pressure on both sides	
		EPDM/FKM	PTFE	EPDM/FKM	PTFE
ø 80	20	10	10	10	10
	25	10	10	10	9
ø 100	40	10	8	8	6
ø 125	50	10	10	10	8.5

Tab. 9: Operating pressure for control function A

Required minimum pilot pressure depending on medium pressure for control function B.

The values in the following graphs apply to:

- Plastic body PVDF (PD), PP (PP), PVC (PV)
- Forged steel body (VS)
- Precision casting body (VG)
- Tube valve body (VP) with ISO- weld end connection
ISO clamp connection
Threaded connection
Welded neck flange



To protect the diaphragm during control function B, preferably do not select the pilot pressure higher than is required to switch the medium pressure.

Control function B / elastomer diaphragm

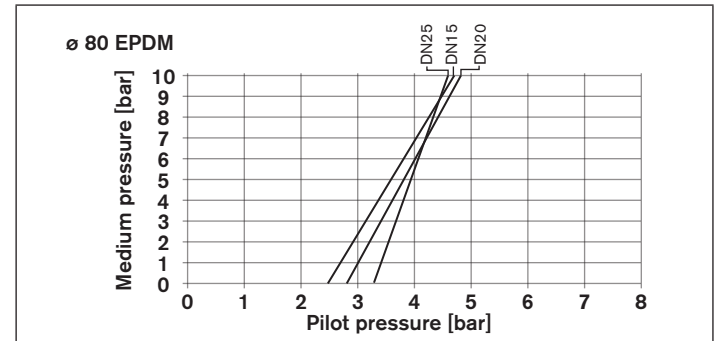

Fig. 6: Pressure graph, actuator ø 80 mm, control function B, elastomer diaphragm

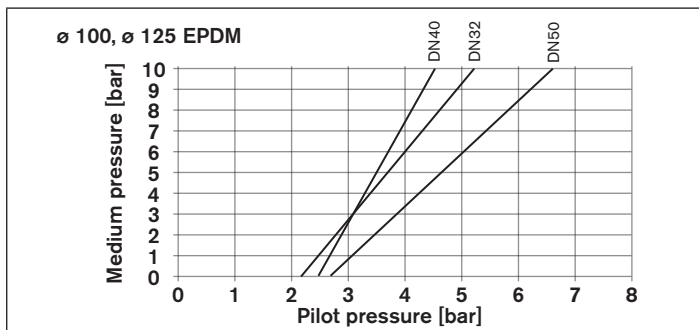

Fig. 7: Pressure graph, actuator \varnothing 100 mm and \varnothing 125 mm, control function B, elastomer diaphragm

Control function B / PTFE diaphragm

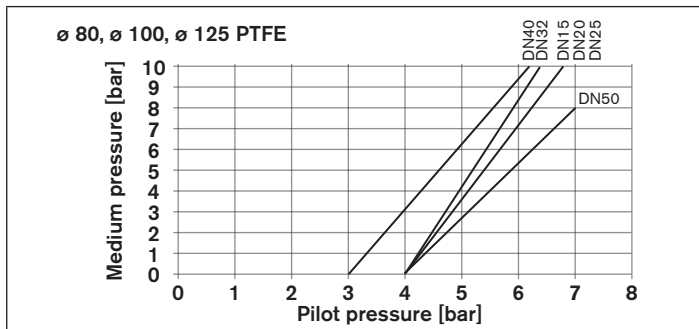

Fig. 8: Pressure graph, actuator \varnothing 80 mm, \varnothing 100 mm and \varnothing 125 mm, control function B, PTFE diaphragm

The values in the following graphs apply to:

- Tube valve body (VP) with
 - DIN weld end connection
 - DIN clamp connection



To protect the diaphragm during control function B, preferably do not select the pilot pressure higher than is required to switch the medium pressure.

Control function B / elastomer diaphragm

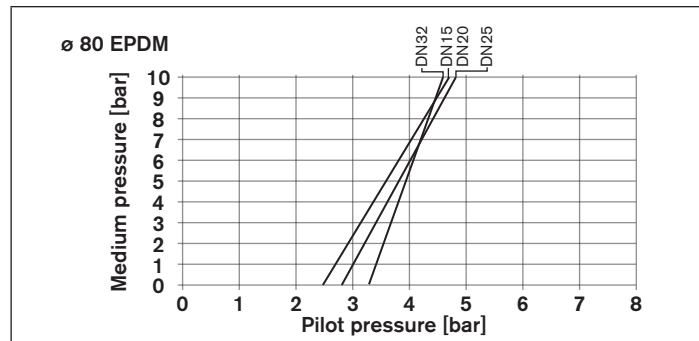

Fig. 9: Pressure graph, actuator \varnothing 80 mm, control function B, elastomer diaphragm

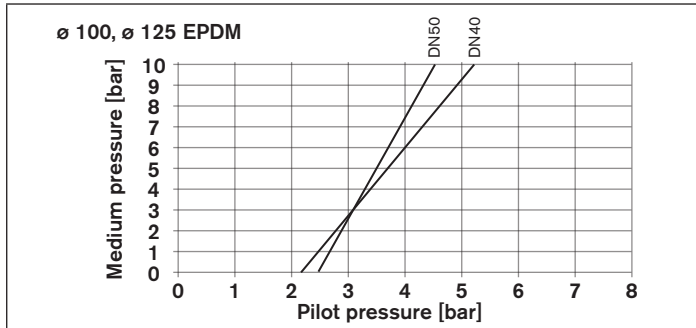

Fig. 10: Pressure graph, actuator \varnothing 100 mm and \varnothing 125 mm, control function B, elastomer diaphragm

Control function B / PTFE diaphragm

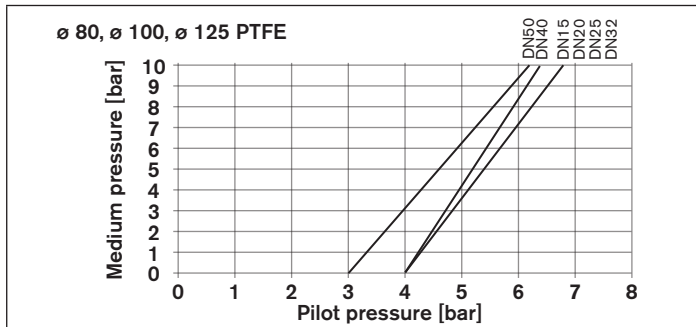

Fig. 11: Pressure graph, actuator \varnothing 80 mm, \varnothing 100 mm and \varnothing 125 mm, control function B, PTFE diaphragm

The values in the following graphs apply to:

- Tube valve body (VP) with OD weld end connection
- BS clamp connection



To protect the diaphragm during control function B, preferably do not select the pilot pressure higher than is required to switch the medium pressure.

Control function B / elastomer diaphragm

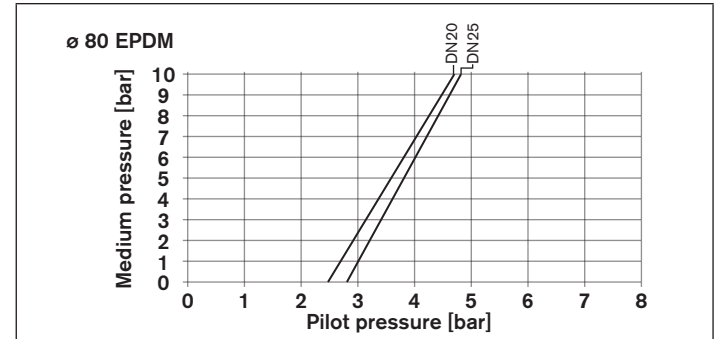

Fig. 12: Pressure graph, actuator \varnothing 80 mm, control function B, elastomer diaphragm

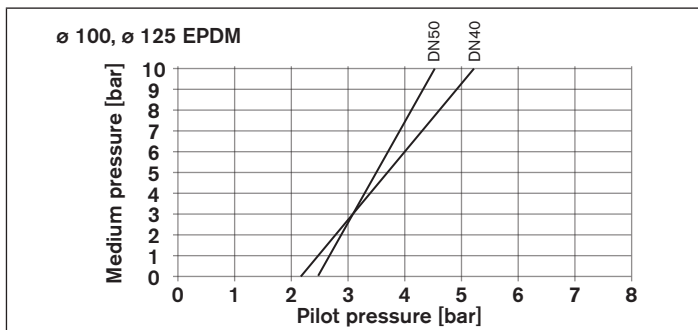

Fig. 13: Pressure graph, actuator ø 100 mm and ø 125 mm, control function B, elastomer diaphragm

Control function B / PTFE diaphragm

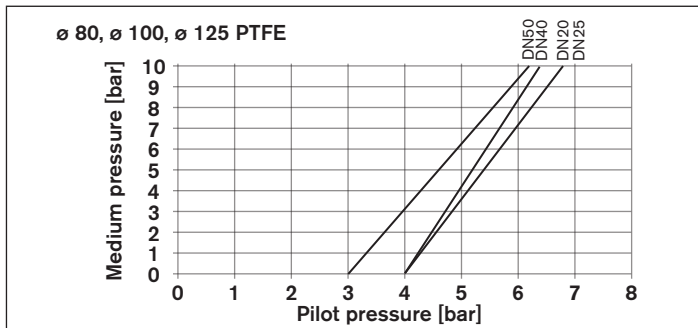

Fig. 14: Pressure graph, actuator ø 80 mm, ø 100 mm and ø 125 mm, control function B, PTFE diaphragm

6.7 Flow values and characteristics



Flow values and characteristics for Types 2730, 2731 and 2731 K you find at www.burkert.com → Type 2730.

6.8 General technical data

Actuator sizes	ø 80 mm, ø 100 mm, ø 125 mm
Connections	
Pilot air port	G1/4, stainless steel
Line connection	
Type 2730	Socket and spigot
Type 2731 / 2731K	Weld end: in accordance with EN ISO 1127 (ISO 4200), DIN 11850 R2 other connections on request

Materials

Body	
Type 2730	PVDF (PD), PP (PP), PVC (PV)
Type 2731	Stainless steel precision casting (VG) 1.4435 (AISI 316L), Stainless steel forged steel (VS) 1.4435 (AISI 316L)
Type 2731K	Tube valve body (VP) cold-formed 1.4404 (316L)
Actuator	PA, PPS
Sealing elements actuator	FKM, NBR

Diaphragm	EPDM in food quality, PTFE/EPDM, FKM
Media	
Control medium	Neutral gases, air Quality classes in accordance with DIN ISO 8573-1
Dust content	Class 5: max. particle size 40 µm, max. particle density 10 mg/m ³
Water content	Class 3: max. pressure dew point - 20 °C or min. 10 °C below the lowest operating temperature
Oil content	Class 5: max. 25 mg/m ³ with TopControl maxi 1 mg/m ³ with SideControl
Flow media	
Type 2730	Liquids; aggressive or abrasive media
Type 2731 / 2731K	Liquids; ultrapure, sterile, aggressive or abrasive media
Viscosity	up to viscous
Installation position	any position, preferably with the actuator face up
Protection class	IP67 in accordance with IEC 529 / EN 60529

7 INSTALLATION



DANGER!

Danger – high pressure in the equipment.

- ▶ Before loosening the lines and valves, turn off the pressure and vent the lines.



WARNING!

Risk of injury from improper installation.

- ▶ Installation may be carried out by authorised technicians only and with the appropriate tools!

Risk of injury from unintentional activation of the system and an uncontrolled restart.

- ▶ Secure system from unintentional activation.
- ▶ Following assembly, ensure a controlled restart.

7.1 Before installation

- Before connecting the valve, ensure the pipelines are flush.
- The flow direction is optional.

7.1.1 Installation position general

Installation for self-drainage of the body



It is the responsibility of the installer and operator to ensure self-drainage.

Installation for leakage detection



One of the bores (in the actuator base) for monitoring leakage must be at the lowest point.

7.1.2 Installation position 2/2-way valve

The piston-controlled diaphragm control valve can be installed in any installation position, preferably with the actuator face up.

To ensure self-drainage:

- Install body inclined by an angle $\alpha = 15^\circ - 35^\circ$ to the horizontal.
- Observe an inclination angle of $1^\circ - 5^\circ$ to the line axis.
Forged and cast body: Mark on the body must point upwards (12 o'clock position, see "Fig. 15").
- One of the bores (in the actuator base) for monitoring leakage must be at the lowest point.

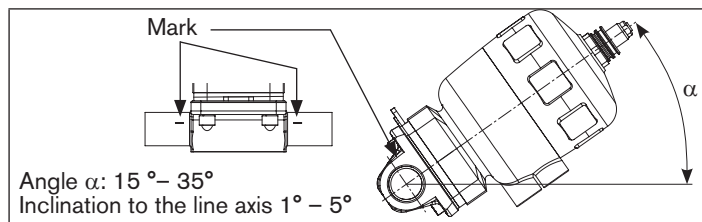

Fig. 15: Installation position for self-drainage of the body

7.1.3 Preparatory work

- Clean pipelines (sealing material, swarf, etc.).
- Support and align pipelines.

Devices with VG/VS/VA welded body:

NOTE!

Damage to the diaphragm or the actuator!

- ▶ Before welding in the body, remove the actuator.

Remove the actuator from the valve body:

NOTE!

Damage to the diaphragm or the seat contour!

- ▶ When removing the actuator, ensure that the valve is in open position.

- Control function A pressurize the lower pilot air port with compressed air (5 bar): valve opens.
- Remove actuator with diaphragm by loosening the body screws.

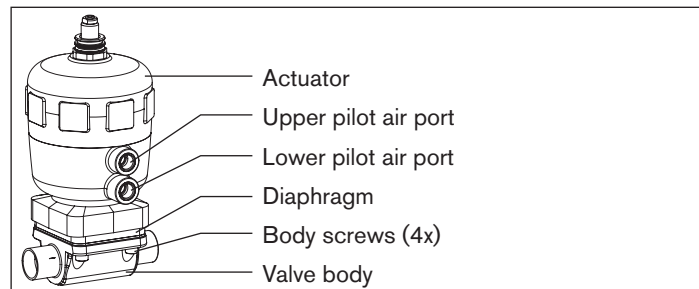

Fig. 16: Installation

7.2 Installation



WARNING!

Risk of injury from improper installation.

Non-observance of the tightening torque is dangerous as the device may be damaged.

- ▶ Observe the tightening torque (see “[Tab. 10: Tightening torques for diaphragms](#)”).

7.2.1 Installation of the valve body

Welded bodies

→ Weld valve body in pipeline system.

Other body versions

→ Connect body to pipeline.

7.2.2 Installation of the actuator (welded body)

Installation for actuator with control function A:

NOTICE!

Damage to the diaphragm or the seat contour!

- ▶ When installing the actuator, ensure that the valve is in open position.
- Control function A pressurize the lower pilot air port with compressed air (5 bar): valve opens.
- Lightly cross-tighten the body screws until the diaphragm is between the body and actuator. **Do not tighten the screws yet.**
- Actuate the diaphragm control valve twice.

→ Without pressurization tighten the body screws to the permitted tightening torque (see following table “[Tab. 10: Tightening torques for diaphragms](#)”).

Installation for actuator with control functions B:

- Lightly cross-tighten the body screws without pressurization until the diaphragm is between the body and actuator. **Do not tighten the screws yet.**
- Pressurize upper pilot air port of the actuator with compressed air (5 bar).
- Actuate the diaphragm control valve twice.
- With pressurization tighten the body screws to the permitted tightening torque (see “[Tab. 10: Tightening torques for diaphragms](#)”).

Orifice DN (diaphragm size)	Tightening torques for diaphragms [Nm]	
	EPDM	PTFE
15	3.5	4
20	4	4.5
25	5	6
32	6	8
40	8	10
50	12	15

Tab. 10: Tightening torques for diaphragms

7.3 Pneumatic connection



DANGER!

Danger – high pressure in the equipment.

- ▶ Before loosening the lines and valves, turn off the pressure and vent the lines.



WARNING!

Risk of injury from unsuitable connection hoses.

Hoses which cannot withstand the pressure and temperature range may result in hazardous situations.

- ▶ Use only hoses which are authorised for the indicated pressure and temperature range.
- ▶ Observe the data sheet specifications from the hose manufacturers.



The operation of the diaphragm control valve Type 2730, 2731 and 2731 K is possible only in combination with an control unit.

Possible control units are:

Positioner Type 8635, 8692, 8694, 8792

Process controller Type 8693, 8793

Observe the type label.



The pneumatic connection of the control unit is described in the respective operating instructions for the control unit.

7.3.1 Connection of the actuator

Control functions A:

→ Connect the control medium to the lower pilot air port of the actuator (see “[Fig. 17: Pneumatic connection](#)”)

Control functions B:

→ Connect the control medium to the upper pilot air port of the actuator (see “[Fig. 17: Pneumatic connection](#)”)

Silencer

For reducing the exhaust air noise: plug the silencer into the free air discharge connection (see “[Fig. 17: Pneumatic connection](#)”)



If used in an aggressive environment, we recommend conveying all free pneumatic connections into a neutral atmosphere with the aid of a pneumatic hose.

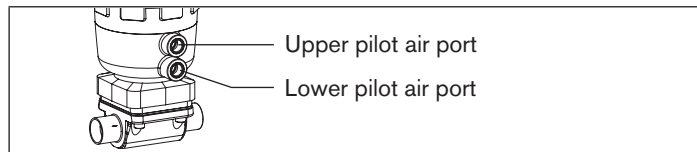

Fig. 17: Pneumatic connection

Control air hose:

Control air hoses of sizes 6/4 mm or 1/4" can be used.

8 REMOVAL



DANGER!

Risk of injury from discharge of medium and pressure.

It is dangerous to remove a device which is under pressure due to the sudden release of pressure or discharge of medium.

- ▶ Before removing a device, switch off the pressure and vent the lines.

→ Loosen the pneumatic connection.

→ Remove the device.

NOTE!

Deformation of the diaphragm.

- ▶ For prolonged storage of the valves, slacken the housing screws.

9 ELECTRICAL CONTROL UNIT

The valve Type 2730, 2731 and 2731K can be combined with following control units:

- Type 8635 Positioner SideControl
- Type 8692 Positioner TopControl
- Type 8694 Positioner TopControl Basic
- Type 8792 Positioner SideControl
- Type 8693 Process controller TopControl
- Type 8793 Process controller SideControl



The electrical connection of the control unit is described in the respective operating instructions for the control unit.

10 MALFUNCTIONS

Malfunction	Cause /remedial action
Actuator does not switch	Pilot air port interchanged ⁴⁾ CFA: Connecting lower pilot air port CFB: Connecting upper pilot air port
	Pilot pressure too low See pressure specifications on the type label.
	Medium pressure too high See pressure specifications on the type label.
Valve is not sealed	Medium pressure too high See pressure specifications on the type label.
	Pilot pressure too low See pressure specifications on the type label.
Flow rate reduced	PTFE diaphragm bulging → Replace diaphragm.

Tab. 11: Malfunctions

⁴⁾ see "Fig. 17: Pneumatic connection"

11 MAINTENANCE



DANGER!

Danger – high pressure in the equipment.

- ▶ Before loosening the lines and valves, turn off the pressure and vent the lines.

Risk of injury due to electrical shock.

- ▶ Before reaching into the system, switch off the power supply and secure to prevent reactivation!
- ▶ Observe applicable accident prevention and safety regulations for electrical equipment!



WARNING!

Risk of injury from improper maintenance.

- ▶ Installation may be carried out by authorized technicians only and with the appropriate tools!

Risk of injury from unintentional activation of the system and an uncontrolled restart.

- ▶ Secure system from unintentional activation.
- ▶ Following maintenance, ensure a controlled restart.

11.1 Maintenance and cleaning

11.1.1 Actuator

The actuator of the diaphragm control valve is maintenance-free provided it is used according to these operating instructions.

11.1.2 Wearing parts of the diaphragm control valve

Parts which are subject to natural wear:

- Seals
- Diaphragm

→ If leaks occur, replace the particular wearing part with an appropriate spare part (see chapter "[12 Replacement parts](#)").



A bulging PTFE diaphragm may reduce the flow.



The replacing of the wearing parts is described in chapter "[11.2](#)".

11.1.3 Inspection intervals

The following maintenance work is required for the diaphragm valve:

- After the first steam sterilization or when required retighten body screws crosswise.
- After maximum 10^5 switching cycles check the diaphragm for wear.



Muddy and abrasive media require correspondingly shorter inspection intervals!

11.1.4 Service life of the diaphragm

The service life of the diaphragm depends on the following factors:

- Diaphragm material
- Medium, medium pressure, medium temperature
- Actuator size
- Pilot pressure for CFB.

Protecting the diaphragm

→ For CFA match the actuator size (actuator force) to the medium pressure to be actuated. If required, select the actuator with reduced spring force EC04.

→ For CFB try and select the pilot pressure not higher than is required to actuate the medium pressure.

11.1.5 Cleaning

Commercially available cleaning agents can be used to clean the outside.

NOTE!

Avoid causing damage with cleaning agents.

- ▶ Before cleaning, check that the cleaning agents are compatible with the body materials and seals.

11.2 Replacing the diaphragm



DANGER!

Risk of injury from discharge of medium and pressure.

It is dangerous to remove a device which is under pressure due to the sudden release of pressure or discharge of medium.

- ▶ Before removing a device, switch off the pressure and vent the lines.

Fastening types

Orifice (Diaphragm size) [mm]	Fastening types for diaphragms	
	PTFE	EPDM / FKM
15	Diaphragm with bayonet catch	Diaphragm with bayonet catch
20		
25	Diaphragm with bayonet catch	Diaphragm screwed in
40		
50		

Tab. 12: Fastening types for diaphragms

Replacement for control function A

- Clamp the valve body in a holding device (applies only to valves not yet installed).

NOTICE!

Damage to the diaphragm or the seat contour!

- ▶ When removing the actuator, ensure that the valve is in open position.

- Pressurize lower pilot air port of the actuator with compressed air (5 bar): valve opens.
- Loosen the four body screws.
- Remove the actuator from the body.
- Unbutton or unscrew old diaphragm. If attachment is with a bayonet catch, remove the diaphragm by rotating it through 90°. For orifice DN25-DN50 observe chapter "[11.2.1](#)".
- Install new diaphragm.
- Align diaphragm.
The marker flap of the diaphragm must be perpendicular to the direction of flow (see "[Fig. 18](#)")!
- Place actuator back on the body.
- Insert the body screws and lightly cross-tighten until the diaphragm is between the body and actuator.
Do not tighten the screws yet.
- Actuate the diaphragm control valve twice.
- Without pressurization tighten the body screws to the permitted tightening torque (see "[Tab. 13: Tightening torques for diaphragms](#)").

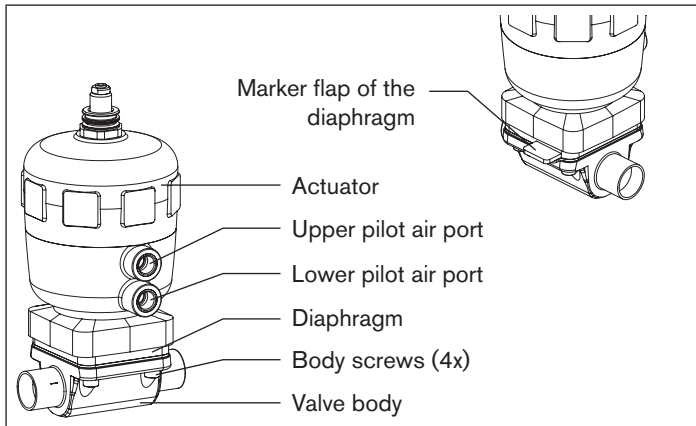

Fig. 18: Repairs

Replacement for control functions B

- Clamp the valve body in a holding device (applies only to valves not yet installed).
- Loosen the four body screws.
- Remove the actuator from the body.
- Unbutton or unscrew old diaphragm. If attachment is with a bayonet catch, remove the diaphragm by rotating it through 90°. For orifice DN25-DN50 observe chapter [“11.2.1”](#).
- Install new diaphragm.
- Align diaphragm.
The marker flap of the diaphragm must be perpendicular to the direction of flow (see [“Fig. 18”](#)).

- Place actuator back on the body.
- Lightly cross-tighten the body screws without pressurization until the diaphragm is between the body and actuator.
Do not tighten screws yet.
- Pressurize upper pilot air **port** of the actuator with compressed air (5 bar) (see [“Fig. 18”](#)).
- Actuate the diaphragm control valve twice.
- With pressurization tighten the body screws to the permitted tightening torque (see [“Tab. 13: Tightening torques for diaphragms”](#)).

Orifice DN (diaphragm size)	Tightening torques for diaphragms [Nm]	
	EPDM	PTFE
15	3.5	4
20	4	4.5
25	5	6
32	6	8
40	8	10
50	12	15

Tab. 13: Tightening torques for diaphragms

11.2.1 Switch between PTFE and EPDM diaphragms

Orifice DN15 and DN20:

→ Loosen PTFE diaphragm bayonet and attach new EPDM diaphragm.

Orifice DN25 up to DN50:

→ Loosen PTFE diaphragm bayonet.

→ Place the insert in the pressure piece.

→ Insert and screw in EPDM diaphragm.

12 REPLACEMENT PARTS



CAUTION!

Risk of injury and/or damage by the use of incorrect parts.

Incorrect accessories and unsuitable replacement parts may cause injuries and damage the device and the surrounding area.

- ▶ Use only original accessories and original replacement parts from Bürkert.

The diaphragm is available as a replacement part for the piston-controlled diaphragm control valve Type 2730, 2731 and 2731K.



If you have any queries, please contact your Bürkert sales office.

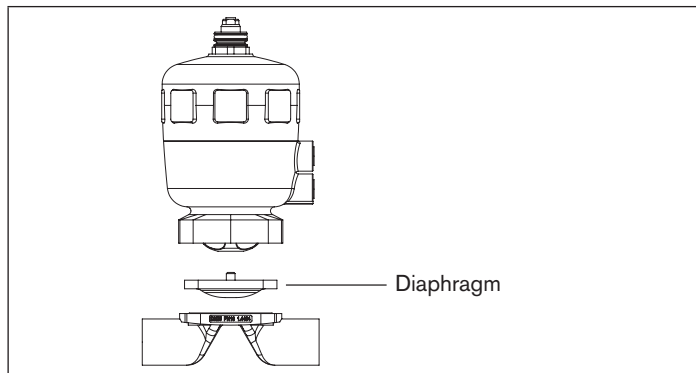

Fig. 19: Diaphragm replacement part

12.1 Order table

Orifice (Diaphragm size) [mm]	Order numbers for diaphragms					
	EPDM (AB*)		EPDM (AD*)		FKM (FF*)	
15	677 664	E02**	688 422	E03**	677 685	F01**
15 BC**	693 162	E02**	693 163	E03**	693 164	F01**
20	677 665	E02**	688 423	E03**	677 686	F01**
20 BC**	693 165	E02**	693 166	E03**	693 167	F01**
25	677 667	E01**	688 424	E03**	677 687	F01**
32	677 668	E01**	688 425	E03**	677 688	F01**
40	677 669	E01**	688 426	E03**	677 689	F01**
50	677 670	E01**	688 427	E03**	677 690	F01**
	PTFE (EA*)		Advanced PTFE (EU*)		Laminated advanced PTFE (ET*)	
15	677 675	E02- PTFE**	679 541	E02- PTFE+ Hole**	677 695	L02**
20	677 676	E02- PTFE**	679 542	E02- PTFE+ Hole**	677 696	L02**
25	677 677	E02- PTFE**	679 543	E02- PTFE+ Hole**	677 697	L01**

32	677 678	E02- PTFE**	679 544	E02- PTFE+ Hole**	-	
40	677 679	E02- PTFE**	679 545	E02- PTFE+ Hole**	677 698	L01**
50	677 680	E02- PTFE**	679 546	E02- PTFE+ Hole**	677 699	L01**

Tab. 14: Order numbers for diaphragms

* SAP Code

** Identification on the diaphragm

13 PACKAGING, TRANSPORT, STORAGE

NOTE!

Transport damages.

Inadequately protected equipment may be damaged during transport.

- During transportation protect the device against wet and dirt in shock-resistant packaging.
- Avoid exceeding or dropping below the permitted storage temperature.

Incorrect storage may damage the device.

- Store the device in a dry and dust-free location.
- Storage temperature -20 – +65 °C.

Damage to the environment caused by device components contaminated with media.

- Dispose of the device and packaging in an environmentally friendly manner.
- Observe applicable regulations on disposal and the environment.



Note:

Observe national waste disposal regulations.

www.burkert.com