

# DELIVERY CONTROLLER

## WITH PUMP START AND VALVE CONTROL



### Advantages

- Robust IP67 (NEMA4X) field enclosure. It is so rugged, **you can even stand on it!**
- Intrinsically Safe available - ATEX and IECEx approval for gas and dust applications.
- Programming can be done by your own crew, with the sensible menu-driven structure, saving cost and irritation. **Know one, know them all!**
- Very diverse mounting possibilities: walls, pipes, panels or directly onto outdoor sensors!

### Features

- Displays supplied quantity, flow rate and status.
- All control functions available for pump start, valve control and flow rate monitoring including flexible response times.
- Selectable on-screen engineering units; volumetric or mass.
- Communication link for customized ticket printing.
- Flow rate monitoring with high and low alarm values.
- Explosion/flame proof  II 2 GD EEx d IIB T5.
- Full Modbus communication RS232/485/TTL.
- Loop or battery powered, 8 - 24V AC/DC or 115 - 230V AC power supply.
- Sensor supply 3.2 / 8.2 / 12 / 24V DC.

### Signal output

- Two control outputs for pump-start and valve control.
- Communication option to monitor or control the process and to print the bill of loading.

### Signal input

#### Flow

- Ability to process all types of flow meter signals: Reed-switch, NAMUR, NPN/PNP pulse, Sine wave (coil), Active pulse signals.

#### Remote control

- Start, stop, pause or continuous signal.

### Applications

- The F-Series is your first and safest choice for field mount indicators. Especially in harsh weather conditions like rain, snow, salty atmospheres and temperatures between -40°C up to +80°C (-40°F up to 176°F) for safe and hazardous area applications!
- For delivery purposes, small scale gas stations or on board of ships or trucks for customer deliveries. For DIN panel mount indicators, check our D-Series.
- Suitable for filling-up multiple compartments within one delivery.

## General information

### Introduction

The F133 is a unique product as it is especially designed for a controlled delivery of undefined quantities. It offers all the functionality known from gas stations to fill-up your car. The unit incorporates special functions with delay times to start a pump first, control a valve and expect a flow within a certain period of time. Moreover, the flow rate and the allowed total dispensed quantity is monitored as well.

If, for whatever reason, no pulses are coming in, the delivery will be terminated after a pre-defined time. Sub-deliveries are also catered for allowing you to fill up several compartments within one and the same delivery. A wide selection of options further enhances the capabilities of this model, which includes Intrinsic Safety and full Modbus communication.

### Display

The display has large 17mm (0.67") and 8mm (0.31") digits which will zero after a start-command and display "leading eight's". During the delivery, the actual dispensed quantity is displayed together with the actual flow rate and the status of the controller. Several resettable and non-resettable totalizers are available as well as a batch counter. All values are backed-up in EEPROM memory every minute.

### Configuration

All configuration settings are accessed via a simple operator menu which can be password protected. Each setting is clearly indicated with an alphanumeric description, which avoids confusing abbreviations and baffling codes. Once familiar with one F-series product, you will be able to program all models in the series without a manual. All settings are safely stored in EEPROM memory in the event of sudden power failure.

### Control outputs

One output is available to control a pump after receiving a start-signal. After the start-up-time, a second output will be switched to control the valve to allow the product to be dispensed. The output signals can be passive NPN, active PNP or an isolated electro-mechanical relay.

### Signal input

The F133 will accept most pulse input signals for volumetric flow or mass flow measurement. The input signal type can be selected by the user in the configuration menu without having to adjust any sensitive mechanical dip-switches or jumpers. Further, two inputs are available to control the process remotely if desired.

### Communication

All process data and settings can be read and modified manually or through the Modbus communication link (RS232 / RS485). After the delivery, the dispensed quantity and batch number is available to be used for ticket printing (B.O.L.). The F133 has the ability to be locked-out until this information has been read and initialized.

### Hazardous areas

This model has been ATEX and IECEx certified Intrinsically Safe for gas and dust applications, with an allowed ambient temperature of -40°C to +70°C (-40°F to +158°F).

A flame proof enclosure with ATEX certification offers the rating  $\text{Ex II 2 GD EEx d IIB T5}$ .

### Enclosures

Various types of enclosures can be selected, all ATEX and IECEx approved. As standard the F133 is supplied in an GRP panel mount enclosure. Most popular is our rugged aluminum field mount enclosure with IP67 / NEMA 4X rating. Both European or U.S. cable gland entry threads are available.

## Overview application F133

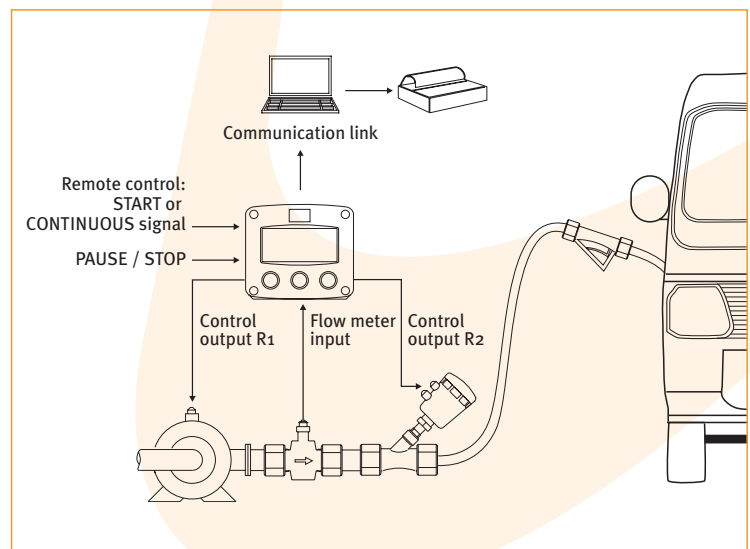

## Dimensions enclosures

### Aluminum & GRP panel mount enclosure

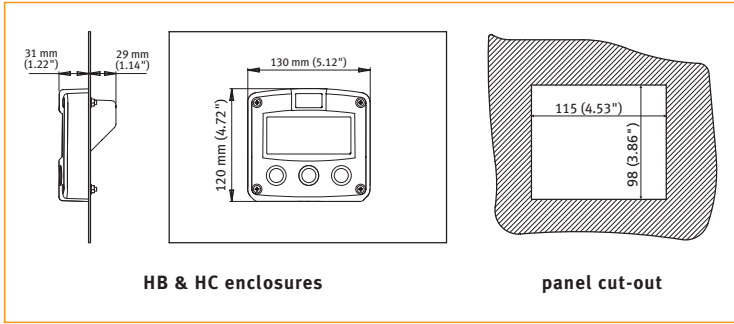

HB & HC enclosures

panel cut-out

### Aluminum & GRP field / wall mount enclosures

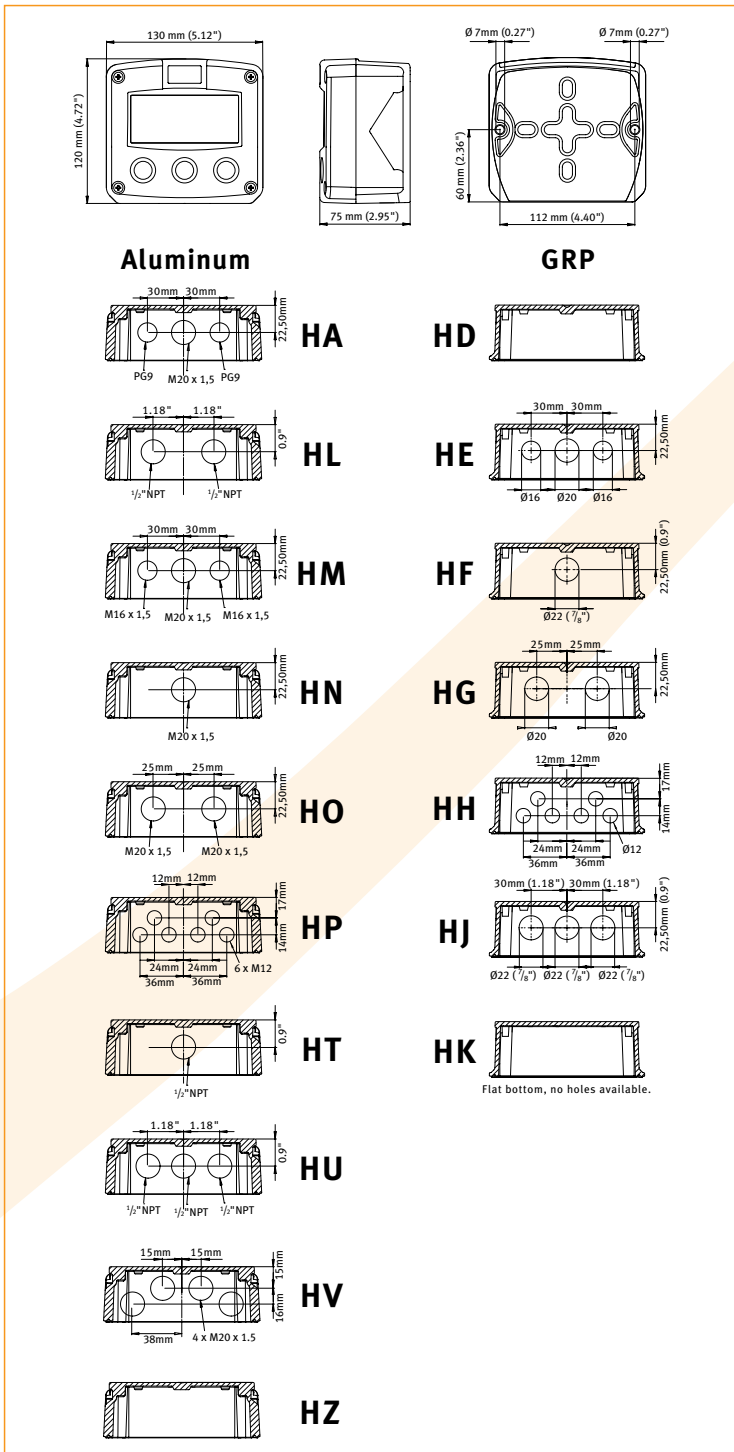

#### Aluminum

#### GRP

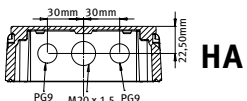

HA

HD

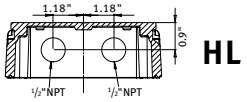

HL

HE

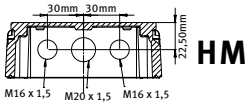

HM

HF

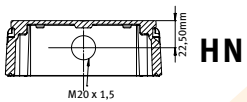

HN

HG

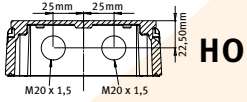

HO

HH

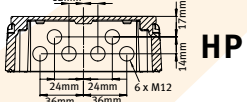

HP

HJ

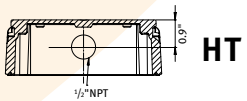

HT

HK

Flat bottom, no holes available.

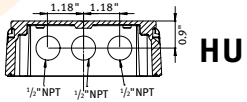

HU

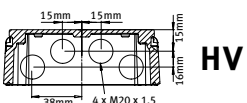

HV

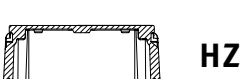

HZ

## Terminal connections

Terminal	Signal / Requirement
1	OPTIONAL POWER REQUIREMENTS: PD 8 - 24V AC
2	OPTIONAL POWER REQUIREMENTS: GND
3	CONTROL VALVE OUTPUT RZ: OA active 24V DC
4	CONTROL VALVE OUTPUT RZ: OT passive trans.
5	CONTROL PUMP OUTPUT RI: OA active 24V DC
6	CONTROL PUMP OUTPUT RI: OT passive trans.
7	BASIC POWER REQUIREMENT: PX 8 - 30V DC
8	BASIC POWER REQUIREMENT: -
9	FLOW METER INPUT: P coil
10	FLOW METER INPUT: P read switch / NPN
11	FLOW METER INPUT: P PNP
12	ADDITIONAL INPUT: IR Start, stop or continuous
13	ADDITIONAL INPUT: -
14	ADDITIONAL INPUT: -
15	ADDITIONAL INPUT: IR Pause or stop
16	ADDITIONAL INPUT: -
17	COMMUNICATION: -
18	COMMUNICATION: -
19	COMMUNICATION: -
20	COMMUNICATION: -
21	COMMUNICATION: -
22	COMMUNICATION: -
23	COMMUNICATION: -
24	COMMUNICATION: -
25	COMMUNICATION: -
26	COMMUNICATION: GB RS232
27	COMMUNICATION: CH RS485 - 2 wire
28	COMMUNICATION: CH RS485 - 4 wire
29	COMMUNICATION: CT TTL Intrinsic Safe
30	COMMUNICATION: DTR +12V
31	COMMUNICATION: TXD

### Display example - 90 x 40mm (3.5" x 1.6")



Typical wiring diagram F133-P-CH-OT-PB-(PX)

Typical wiring diagram F133-P-CH-OT-PX

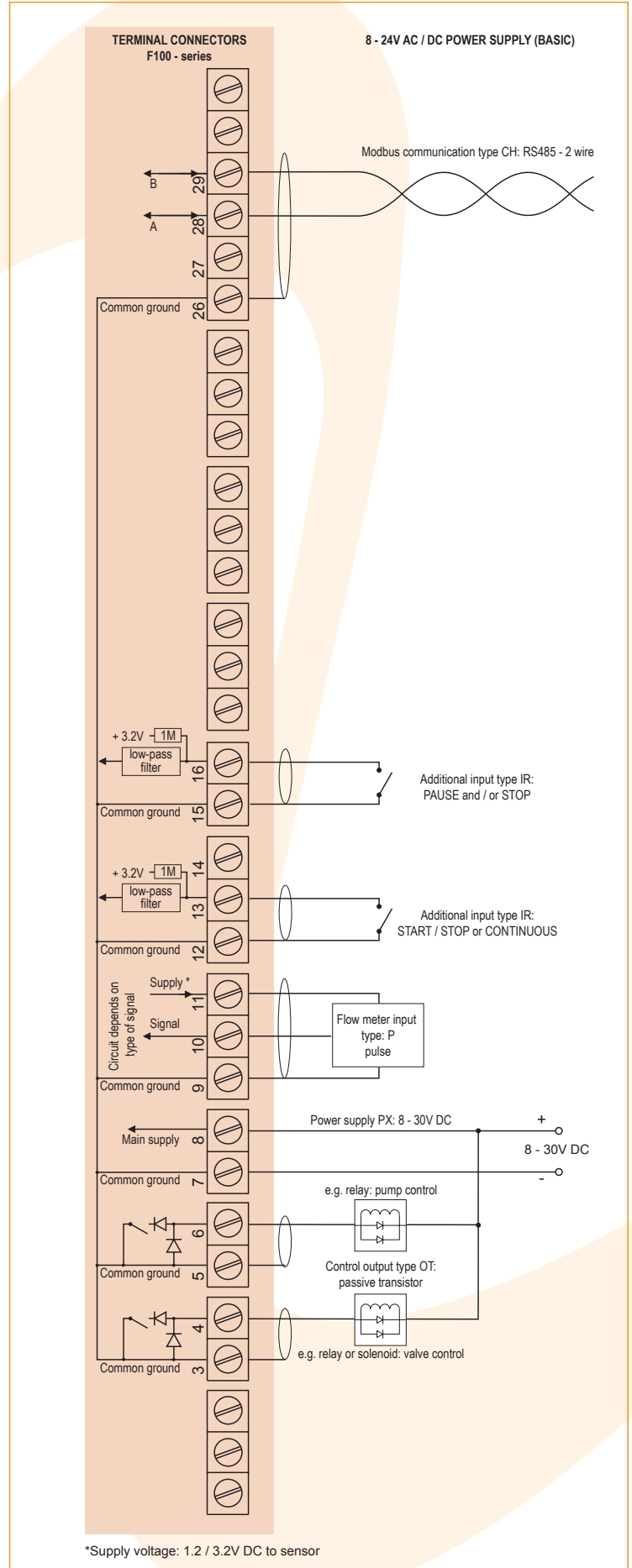
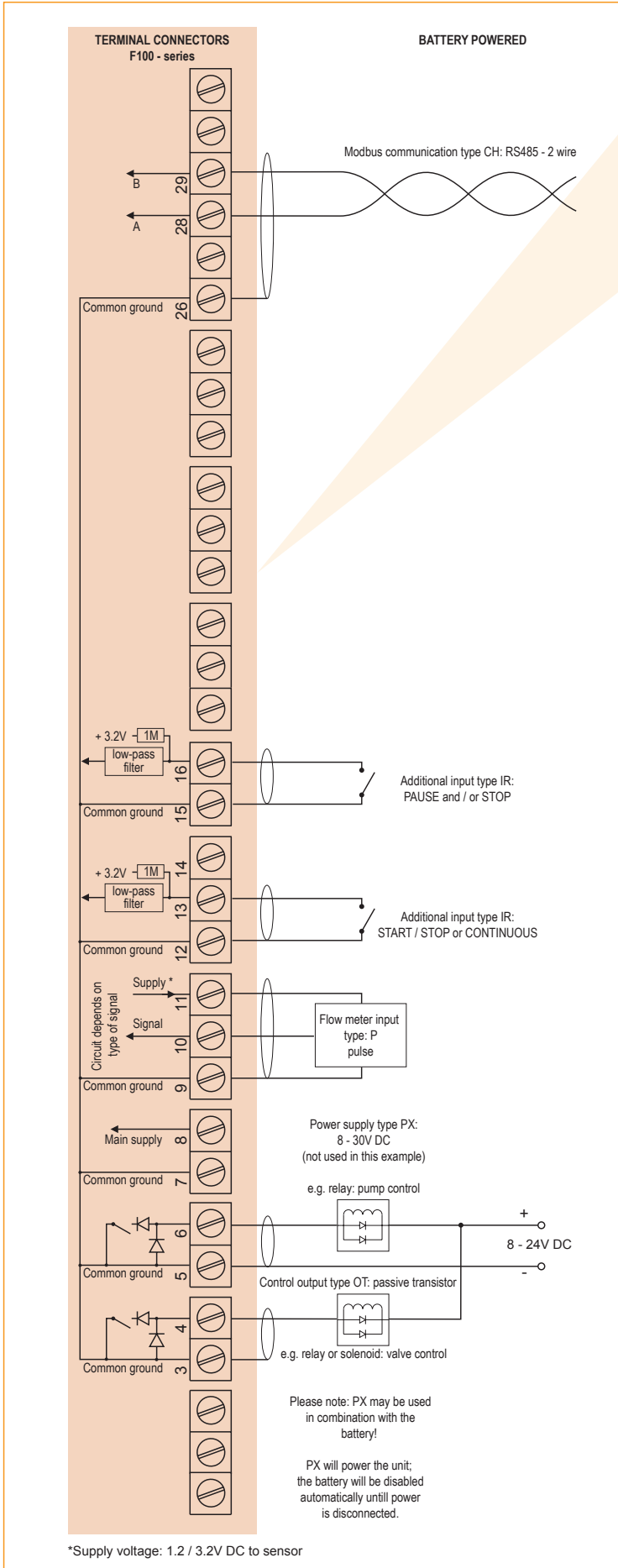

Typical wiring diagram F133-P-CB-OA-PD

Typical wiring diagram F133-P-CI-OR-PM

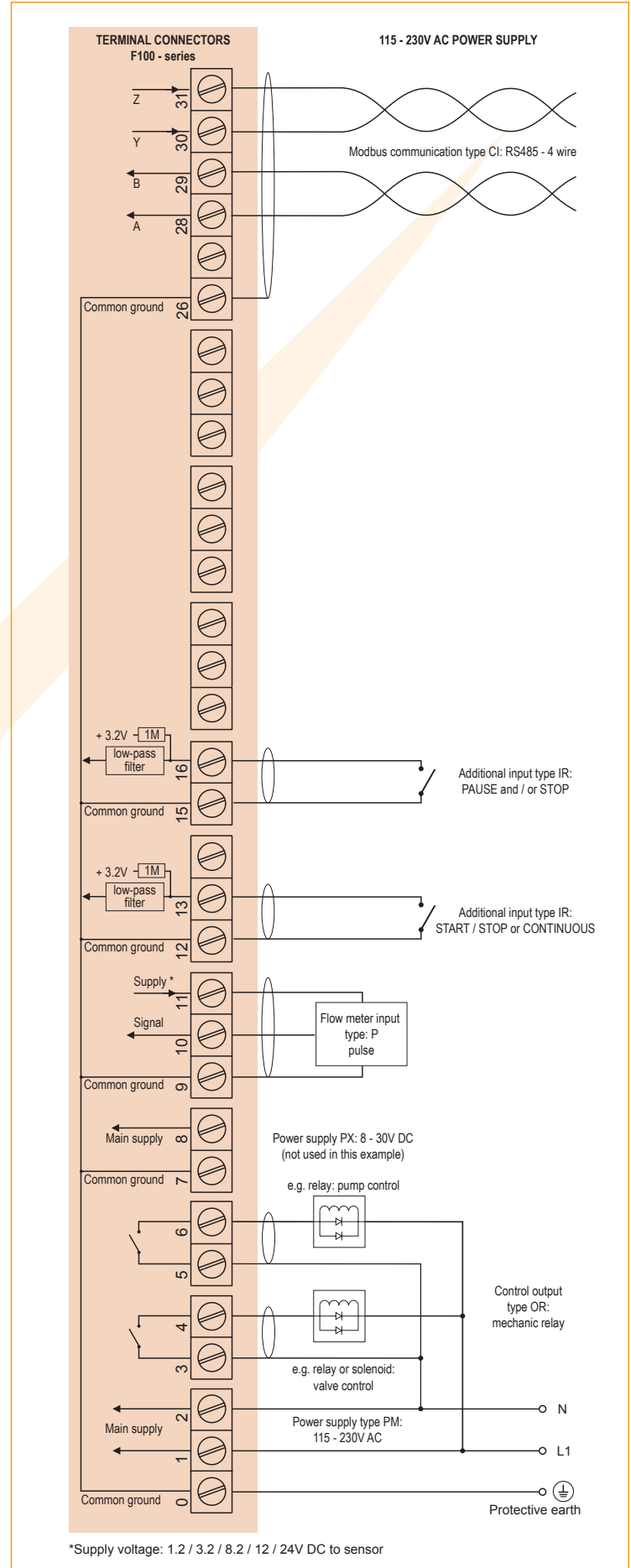
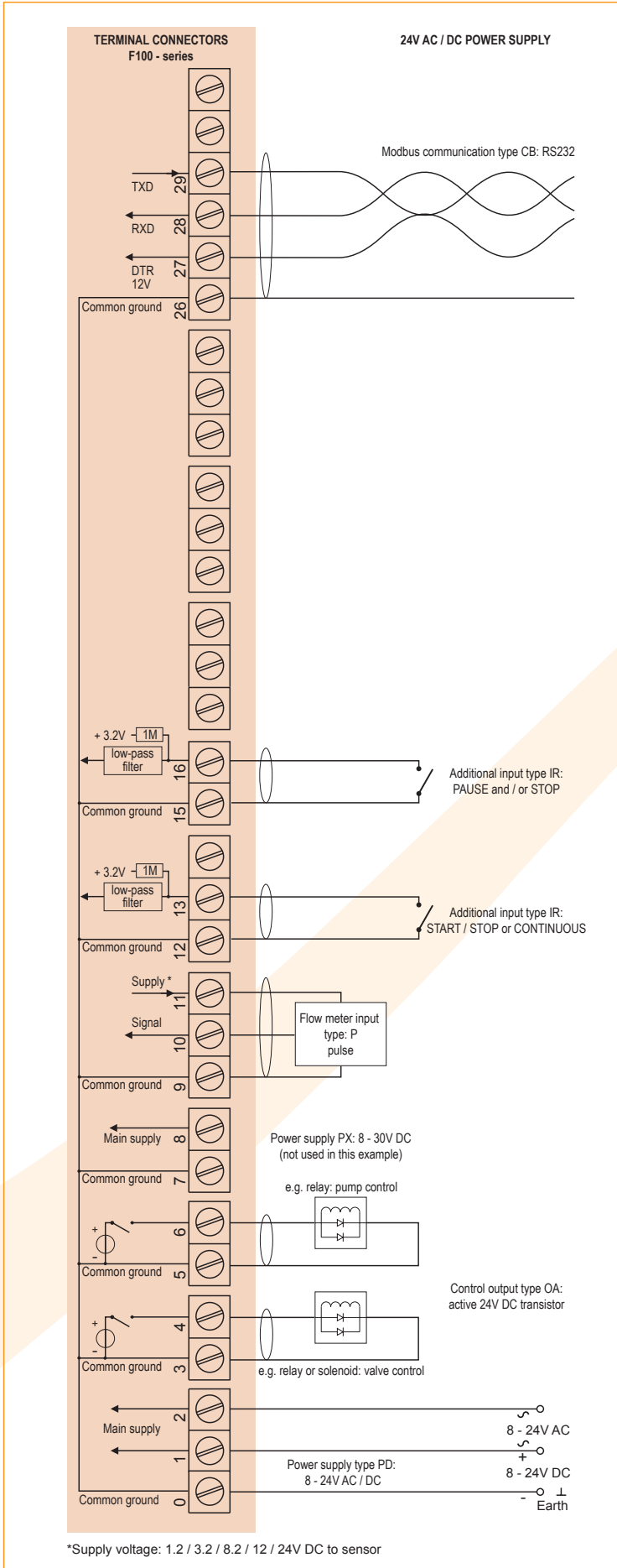

## Hazardous area applications

The F133-XI has been certified according ATEX and IECEx by DEKRA for use in Intrinsically Safe applications with an ambient temperature of -40°C to +70°C (-40°F to +158°F).

- The ATEX markings for gas and dust applications are:

**Ex II 1 G Ex ia IIB/IIC T4 Ga**  
**II 1 D Ex ia IIIC T100 °C Da IP6X.**

- The IECEx markings for gas and dust applications are: **Ex ia IIC/IIB T4 Ga** and **Ex ia IIIC T100 °C Da IP6X.**

Besides the I.S. power supplies for the control outputs, it is allowed to connect up to two I.S. power supplies in IIB/IIC applications or one in IIC applications. Consult the certificate for the maximum input and output values of the circuits. Full functionality of the F133 remains available, including pump and valve control and Modbus communication (type CT). Power supply type PD-XI offers a 8.2V sensor supply e.g. for one Namur sensor.

A flame proof enclosure with rating ATEX **Ex II 2 GD EEx d IIB T5** is available as well. Please contact your supplier for further details.

## Certificate of conformity KEMA 03ATEX1074 X

• IECEx DEK 11.0042X

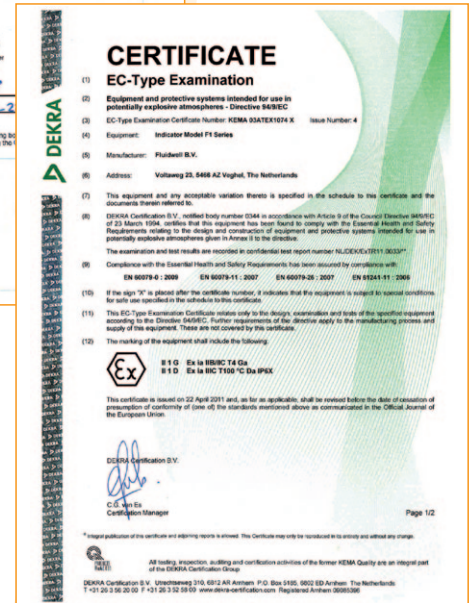

## Configuration example IIB / IIIC and IIC - F133-P-(CT)-OT-PC-(PX)-XI - Battery powered unit

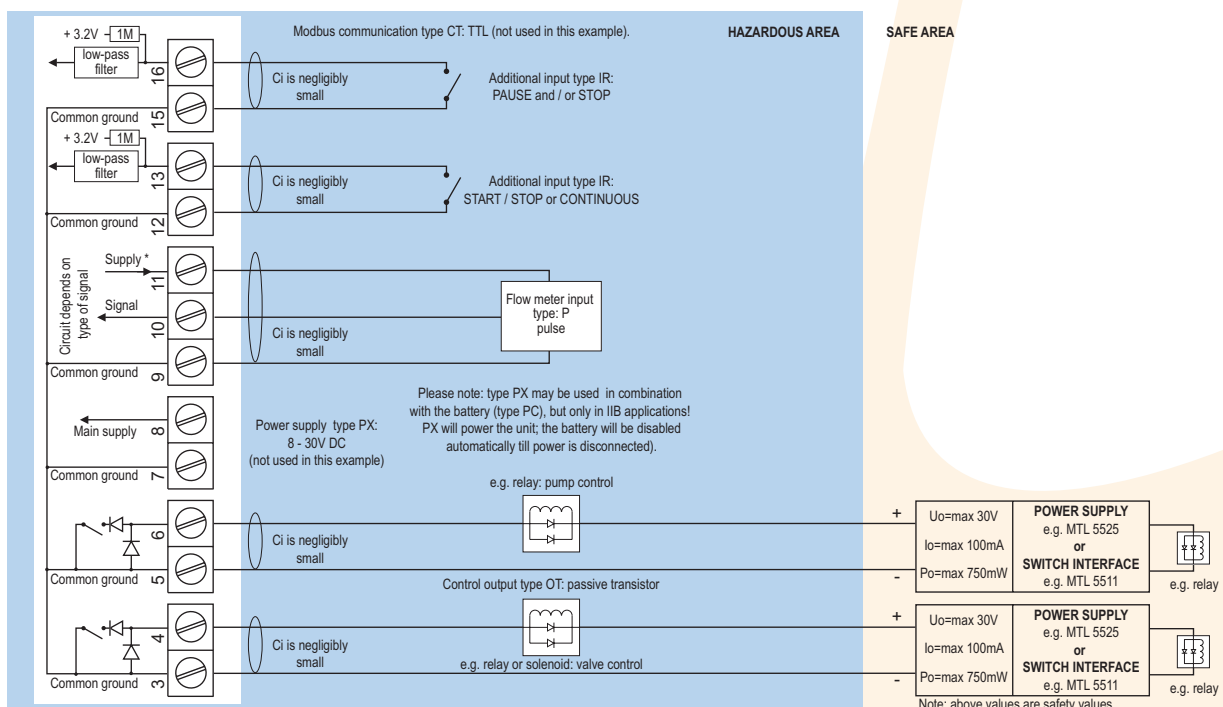

\* Note sensor supply voltage: 1.2V DC for coil sensors or 3.2V DC for other pulse sensors.

Note: above values are safety values. Consult the technical specification for operational values.

# Configuration example IIB / IIIC and IIC - F133-P-(CT)-OT-PX-XI - Basic power requirement 8 - 30V DC

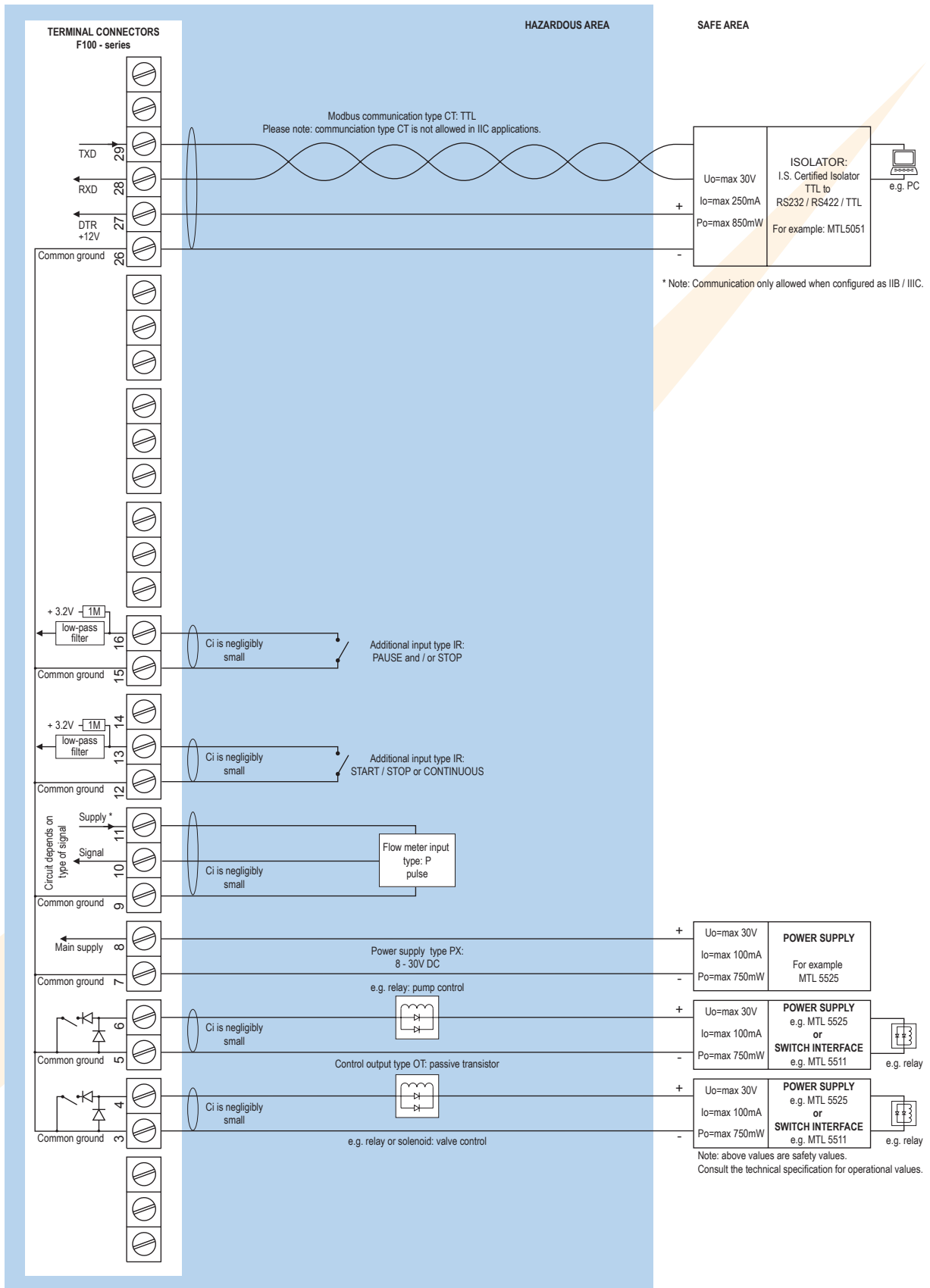

\* Note sensor supply voltage: 1.2 V DC for coil sensors or 3.2V DC for other pulse sensors.

Configuration example IIB / IIC and IIC - F133-P-(CT)-OT-PD-XI - Power requirement 16 - 30V DC

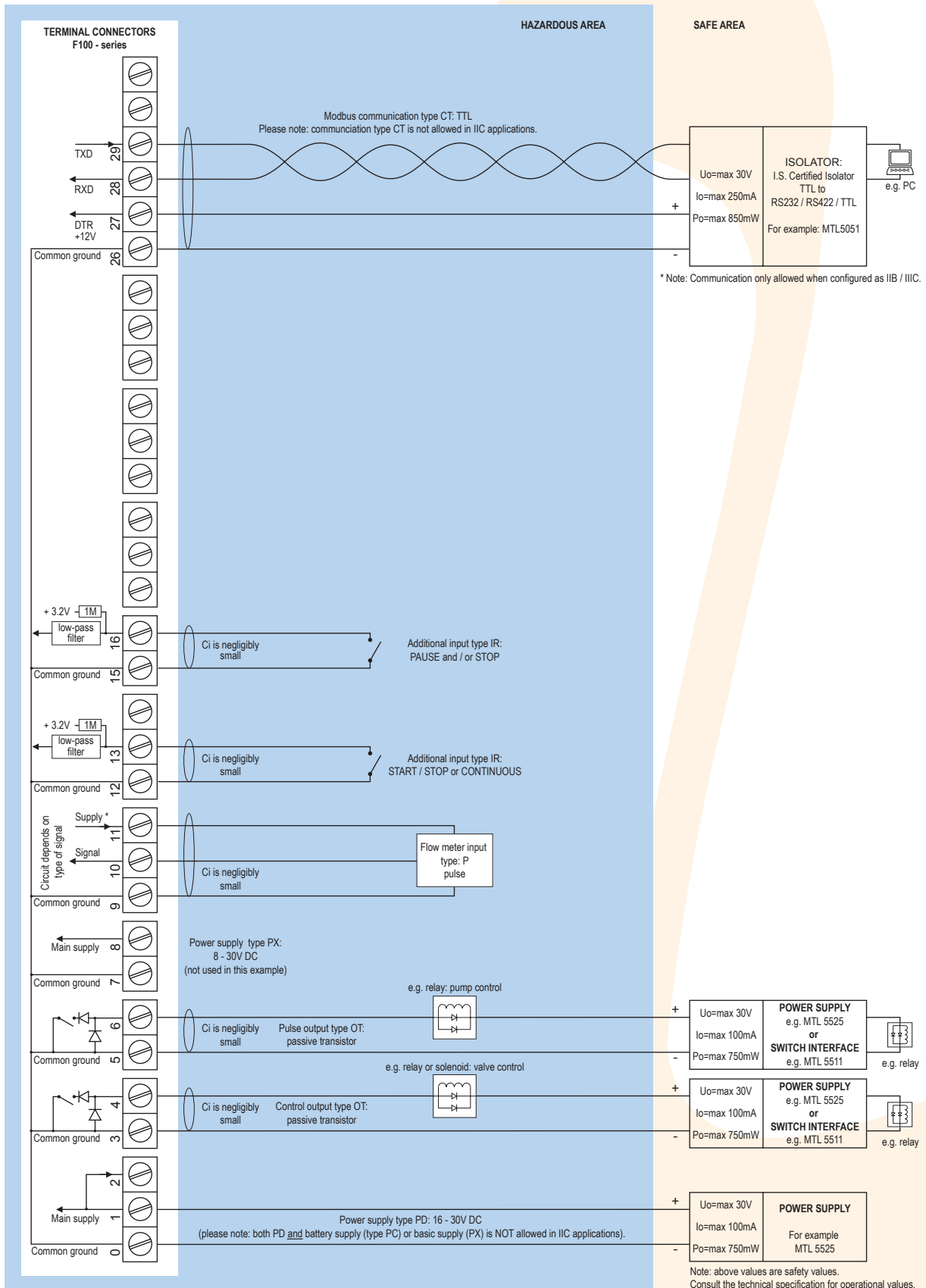

\* Note power supply type PD: the supply voltage to pulse sensors is maximum 8.7V (U<sub>o</sub>=max 8.7V I<sub>o</sub>=max 25mA P<sub>o</sub>=max 150mW) and to analog sensors as connected to terminal 1 (internally linked).



## Configuration example IIB / IIIC - F133-P-CT-OT-PX-XI - Basic power requirement 8 - 30V DC

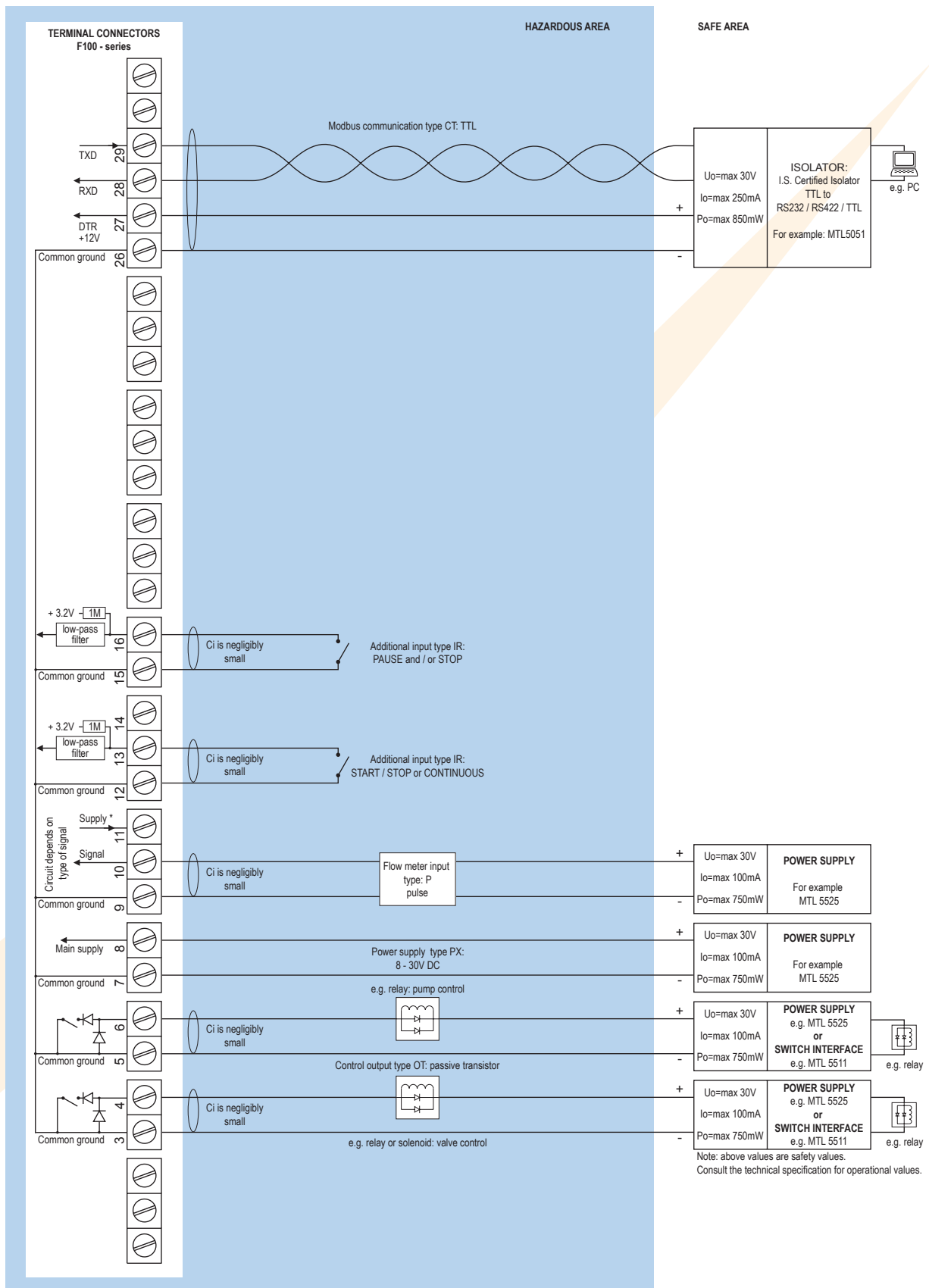

\* Note sensor supply voltage: 1.2 V DC for coil sensors or 3.2V DC for other pulse sensors.

## Technical specification

### General

Display	
Type	High intensity reflective numeric and alphanumeric LCD, UV-resistant.
Dimensions	90 x 40mm (3.5" x 1.6").
Digits	Seven 17mm (0.67") and eleven 8mm (0.31") digits. Various symbols and measuring units.
Refresh rate	User definable: fast, 1sec, 3sec, 15sec, 30sec, off.
Option ZB	Transflective LCD with adjustable green LED backlight. Good readings in full sunlight and darkness.
Note ZB	Only available for safe area applications.

### Ambient temperature

Safe areas	-40°C to +80°C (-40°F to +176°F).
Intrinsically Safe	-40°C to +70°C (-40°F to +158°F).

### Power requirements

Type PB	Long life Lithium battery - life-time depends upon settings and configuration - up to 5 years.
Type PC	Intrinsically Safe long life lithium battery - life-time depends upon settings and configuration - up to 5 years.
Type PD	8 - 24V AC / DC ± 10%. Power consumption max. 10 Watt. Intrinsically Safe: 16 - 30V DC; power consumption max. 0.75 Watt.
Type PF	24V AC / DC ± 10%. Power consumption max. 15 Watt.
Type PM	115 - 230V AC ± 10%. Power consumption max. 15 Watt.
Type PX	8 - 30V DC. Power consumption max. 0.5 Watt.
Type ZB	12 - 24V DC ± 10% or internally powered with type PD / PF / PM. Power consumption max. 1 Watt.
Note PB/PF/PM	Not available Intrinsically Safe.
Note PF/PM	The total consumption of the sensors and outputs may not exceed 400mA @ 24V.
Note	For Intrinsically Safe applications, consult the safety values in the certificate.

### Sensor excitation

Type PB/PC/PX	3.2V DC for pulse signals and 1.2V DC for coil pick-up.
Note	This is not a real sensor supply. Only suitable for sensors with a very low power consumption like coils (sine wave) and reed-switches.
Type PD	1.2 / 3.2 / 8.2 / 12 / 24V DC - max. 50mA @ 24V DC.
Type PD-XI	1.2 / 3.2 / 8.2V DC - max. 7mA @ 8.2V DC and mains power supply voltage (as connected to terminal 1).
Type PF / PM	1.2 / 3.2 / 8.2 / 12 / 24V DC - max. 400mA @ 24V DC.

### Terminal connections

Type	Removable plug-in terminal strip. Wire max. 1.5mm <sup>2</sup> and 2.5mm <sup>2</sup> .
------	--

### Data protection

Type	EEPROM backup of all settings. Backup of running totals every minute. Data retention at least 10 years.
Password	Configuration settings can be password protected.

### Directives & Standards

EMC	Directive 2004/108/EC, FCC 47 CFR part 15.
Low voltage	Directive 2006/95/EC
ATEX / IECEx	Directive 94/9/EC, IEC 60079-0, IEC 60079-11, IEC 60079-26.
IP & NEMA	EN 60529 & NEMA 250

### Enclosure

#### General

Window	Polycarbonate window.
Sealing	Silicone.
Control keys	Three industrial micro-switch keys. UV-resistant silicone keypad.

#### Aluminum wall / field mount enclosures

General	Die-cast aluminum wall/field mount enclosure IP67 / NEMA 4X with 2-component UV-resistant coating.
Dimensions	130 x 120 x 75mm (5.12" x 4.72" x 2.95") - W x H x D.
Weight	1100 gr.
Type HA	Cable entry: 2 x PG9 and 1 x M20.
Type HL	Cable entry: 2 x 1/2" NPT.
Type HM	Cable entry: 2 x M16 and 1 x M20.
Type HN	Cable entry: 1 x M20.
Type HO	Cable entry: 2 x M20.
Type HP	Cable entry: 6 x M12.
Type HT	Cable entry: 1 x 1/2" NPT.
Type HU	Cable entry: 3 x 1/2" NPT.
Type HV	Cable entry: 4 x M20.
Type HZ	Cable entry: no holes.

#### GRP wall / field mount enclosures



General	GRP wall/field mount enclosure IP67 / NEMA 4X, UV-resistant and flame retardant.
Dimensions	130 x 120 x 75mm (5.12" x 4.72" x 2.95") - W x H x D.
Weight	600 gr.
Type HD	Cable entry: no holes.
Type HE	Cable entry: 2 x Ø 16mm and 1 x Ø 20mm.
Type HF	Cable entry: 1 x Ø 22mm (7/8").
Type HG	Cable entry: 2 x Ø 20mm.
Type HH	Cable entry: 6 x Ø 12mm.
Type HJ	Cable entry: 3 x Ø 22mm (7/8").
Type HK	Flat bottom, cable entry: no holes.

#### Panel mount enclosures

Dimensions	130 x 120 x 60mm (5.12" x 4.72" x 2.36") - W x H x D.
Panel cut-out	115 x 98mm (4.53" x 3.86") L x H.
Type HB	Die-cast aluminum panel mount enclosure IP65 / NEMA 4X.
Weight	600 gr.
Type HC	GRP panel mount enclosure IP65 / NEMA 4X, UV-resistant and flame retardant.
Weight	450 gr.

## Hazardous area

### Intrinsically Safe (Type XI)

ATEX certification	 II 1 G Ex ia IIB/IIC T4 Ga. II 1 D Ex ia IIIC T100 °C Da IP6X.
IECEX certification	 Ex ia IIC/IIB T4 Ga. Ex ia IIIC T100 °C Da IP6X.
Ambient Ta	-40°C to +70°C (-40°F to +158°F).

### Explosion proof (Type XF)

ATEX certification	 II 2 GD EEx d IIB T5.
Dimensions	300 x 250 x 200mm (11.8" x 9.9" x 7.9") L x H x D.
Weight	Appr. 15kg.

## Signal inputs

### Flow meter

Type P	Coil / sine wave (HI: 20mVpp or LO: 80mVpp - sensitivity selectable), NPN/PNP, open collector, reed-switch, Namur, active pulse signals 8 - 12 and 24V DC.
Frequency	Minimum 0Hz - maximum 7kHz for total and flow rate. Maximum frequency depends on signal type and internal low-pass filter. E.g. reed switch with low-pass filter: max. frequency 120Hz.
K-Factor	0.000010 - 9,999,999 with variable decimal position.
Low-pass filter	Available for all pulse signals.
Option ZF	coil sensitivity 10mVpp.

### Additional inputs

Function	Remote control: Two terminal inputs to start, pause and stop or continuous signal.
Type IR	Internally pulled-up switch contact - NPN.
Duration	Minimum pulse duration 300msec.

## Signal outputs

### Digital outputs

Function	To control a pump and a valve.
Type OA	Two active 24V DC transistor outputs (PNP); max. 50mA per output (requires PD, PF or PM).
Type OR	Two electro-mechanical relay outputs (N.O.) - isolated; max. switch power 230V AC - 0.5A per relay (requires PF or PM).
Type OT	Two passive transistor outputs (NPN) - not isolated. Max. 50V DC - 300mA per output.

### Communication option

Function	Reading display information, reading / writing all configuration settings + lockout function.
Protocol	Modbus RTU.
Speed	1200 - 2400 - 4800 - 9600 baud.
Addressing	Maximum 255 addresses.
Type CB	RS232
Type CH	RS485 2-wire
Type CI	RS485 4-wire
Type CT	TTL Intrinsically Safe.

## Operational

### Operator functions

Displayed functions	<ul style="list-style-type: none"><li>• Leading eight's before zeroing.</li><li>• Supplied quantity.</li><li>• Flow rate.</li><li>• Resettable supplied quantity (automatically after new start-command).</li><li>• Non-resettable accumulated supplied quantity.</li><li>• Resettable total measured quantity.</li><li>• Non-resettable accumulated total measured quantity.</li><li>• Non-resettable batch counter.</li><li>• High flow rate monitoring</li><li>• Low flow rate monitoring</li></ul>
---------------------	--

### Total

Digits	7 digits.
Units	L, m <sup>3</sup> , GAL, USGAL, kg, lb, bbl, no unit.
Decimals	0 - 1 - 2 or 3.
Note	Total can be reset to zero.

### Accumulated total

Digits	11 digits.
Units / decimals	According to selection for total.
Note	Can not be reset to zero.

### Flow rate

Digits	7 digits.
Units	mL, L, m <sup>3</sup> , Gallons, kg, Ton, lb, bl, cf, RND, ft <sup>3</sup> , scf, Nm <sup>3</sup> , NI, igal - no units.
Decimals	0 - 1 - 2 or 3.
Time units	/sec - /min - /hr - /day.

### Alarm values

Digits	7 digits.
Units	According to selection for flow rate.
Decimals	According to selection for flow rate.
Time units	According to selection for flow rate.
Type of alarm	Low, high flow rate alarm. Includes alarm delay time.

### Batch counter

Function	Value will be incremented after every successful delivery.
Digits	7.
Note	Non-resettable.

## Accessories

### Mounting accessories

ACFo2	Stainless steel wall mounting kit.
ACFo5	Stainless steel pipe mounting kit (worm gear clamps not included).
ACFo6	Two stainless steel worm gear clamps Ø 44 - 56mm.
ACFo7	Two stainless steel worm gear clamps Ø 58 - 75mm.
ACFo8	Two stainless steel worm gear clamps Ø 77 - 95mm.
ACFo9	Two stainless steel worm gear clamps Ø 106 - 138mm.
ACF10	Customized Grevopal tagplates for ACFo2 and ACFo5, including stainless steel screws. Dimension: 95mm x 12.5mm (3.75" x 0.50").

## Ordering information

Standard configuration: F133-P-AX-CX-EX-HC-IR-OT-PX-TX-XX-ZX.

Ordering information: F133 - -AX -C -EX -H -IR -O -P -TX -X -Z

### Flow meter input signal

**P**  Pulse input: coil, npn, pnp, namur, reed-switch.

### Analog output signal

**AX**  No analog output.

### Communication

**CB** Communication RS232 - Modbus RTU.

**CH** Communication RS485 - 2 wire - Modbus RTU.

**CI** Communication RS485 - 4 wire - Modbus RTU.

**CT**  Intrinsically Safe TTL - Modbus RTU.

**CX**  No communication.

### Flow equations

**EX**  No flow equations.

### Panel mount enclosures - IP65 / NEMA4X

**HB**  Aluminum enclosure.

**HC**  GRP enclosure.

### GRP field / wall mount enclosures - IP67 / NEMA4X

**HD**  Cable entry: no holes.

**HE**  Cable entry: 2 x Ø 16mm & 1 x Ø 20mm.

**HF**  Cable entry: 1 x Ø 22mm (7/8").

**HG**  Cable entry: 2 x Ø 20mm.

**HH**  Cable entry: 6 x Ø 12mm.

**HJ**  Cable entry: 3 x Ø 22mm (7/8").

**HK**  Flat bottom, cable entry: no holes.

### Aluminum field / wall mount enclosures - IP67 / NEMA4X

**HA**  Cable entry: 2 x PG9 + 1 x M20.

**HL**  Cable entry: 2 x 1/2"NPT.

**HM**  Cable entry: 2 x M16 + 1 x M20.

**HN**  Cable entry: 1 x M20.

**HO**  Cable entry: 2 x M20.

**HP**  Cable entry: 6 x M12.

**HT**  Cable entry: 1 x 1/2"NPT.

**HU**  Cable entry: 3 x 1/2"NPT.

**HV**  Cable entry: 4 x M20.

**HZ**  Cable entry: no holes.

### Additional input signal

**IR**  Remote control input to start, pause or stop.

### Digital output signals

**OA** Two active transistor outputs - requires PD, PF or PM.

**OR** Two mechanical relay outputs - requires PF or PM.

**OT**  Two passive transistor outputs - standard configuration.

### Power requirements

**PB** Lithium battery powered.

**PC**  Lithium battery powered - Intrinsically Safe.

**PD**  8 - 24V AC / DC + sensor supply - with XI: 16 - 30V DC.

**PF** 24V AC / DC + sensor supply.

**PM** 115 - 230V AC + sensor supply.

**PX**  Basic power supply 8 - 30V DC (no real sensor supply).

### Temperature input signal

**TX**  No temperature input signal.

### Hazardous area

**XI**  Intrinsically Safe, according ATEX and IECEx.

**XF** EExd enclosure - 3 keys.

**XX** Safe area only.

### Other options

**ZB** Adjustable backlight.

**ZF** Coil input 10mVpp.

**ZX**  No options.

The bold marked text contains the standard configuration.

 Available Intrinsically Safe.

Specifications are subject to change without notice.



Quality  
ISO 9001

www.dekra-seal.com

Fluidwell bv

P.O. Box 6

5460 AA - Veghel - The Netherlands

Telephone: +31 (0)413 343 786

Telefax: +31 (0)413 363 443

email: displays@fluidwell.com

Internet: www.fluidwell.com

