

# RATIO CONTROLLER

WITH ANALOG CONTROL OUTPUT  
AND HIGH / LOW ALARMS



## Advantages

- Robust IP67 (NEMA4X) field enclosure. It is so rugged, **you can even stand on it!**
- Intrinsically Safe available - ATEX and IECEx approval for gas and dust applications.
- Programming can be done by your own crew, with the sensible menu-driven structure, saving cost and irritation. **Know one, know them all!**
- Very diverse mounting possibilities: walls, pipes, panels or directly onto outdoor sensors!

## Features

- Controls the desired ratio between a main and an additive flow.
- Displays flow rate A and B, alarms, ratio setpoint and actual ratio in percentage.
- Safety mode input to place the controller in a safe predefined position.
- Two alarm values can be entered in %: low and high ratio alarm.
- Easy operation mode switching : Hand/Local/Ratio.
- Explosion/flame proof  II 2 GD EEx d IIB T5.
- Full Modbus communication RS232/485/TTL.
- Loop or battery powered, 8 - 24V AC / DC or 115 - 230V AC power supply.

## Signal output

- (0)4 - 20mA / 0 - 10V DC control output.
- Two alarm outputs for low and high ratio alarm.

## Signal input

### Flow

- Ability to process all types of flow meter signals: Reed-switch, NAMUR, NPN/PNP pulse, Sine wave (coil), Active pulse signals, (0)4 - 20mA, 0 - 10V DC.

### Remote control

- Safety mode input.

## Applications

- The F-Series is your first and safest choice for field mount indicators. Especially in harsh weather conditions like rain, snow, salty atmospheres and temperatures between -40°C up to +80°C (-40°F up to 176°F) for safe and hazardous area applications!
- In-line blending can be significantly affected by its control operations. The F124 ratio controller will show a strong influence of maintaining a good and constant quality of products and saves money on the blending components. For DIN panel mount indicators, check our [D-Series](#).

## General information

### Introduction

The F124 has been designed to ensure that two flows are kept at the same ratio even if the flows are changing. The F124 is a key product of the Fluidwell Process Controller family and is the alternative to replace existing pneumatic controllers in local control loops.

### Operational

There are three operation modes:

*Hand:* the control output can be manually changed, there is no loop connection.

*Local:* the setpoint can be set and/or changed, corresponding with the process value of flow B.

*Ratio:* (normal operation) set the desired ratio in %, the process value corresponds with flow  $B/A$ .

### Display

The display has large 17mm segments which show flowrate A and B, desired ratio and actual ratio. On-screen engineering units are easily configured from a comprehensive selection.

### Configuration

All configuration settings are accessed via a simple operator menu which can be password protected. Each setting is clearly indicated with an alphanumerical description, which avoids confusing abbreviations and baffling codes. Once familiar with one F-series product, you will be able to program all models in the series without a manual. All settings are safely stored in EEPROM memory in the event of sudden power loss.

### Analog output signal

The valve of the additive flow is controlled via the (o)4 - 20mA or o - 10V DC output signal. The output signal is updated eight times per second. The output signal can be passive, active or isolated where the passive output type will loop power the F124 as well.

### Signal input

The F124 accepts most pulse and analog input signals for volumetric flow or mass flow. The input signal type can be selected by the user in the configuration menu without having to adjust any sensitive mechanical dip-switches or jumpers. The analog input is available with linear and square root calculation and even as 4 - 20mA input loop powered.

### Alarm output

Two fixed alarm outputs are available to transmit the ratio alarm condition, 1 low and 1 high alarm output. The output signals can be a passive NPN, active PNP or an isolated electro-mechanical relay. If there is a no-flow the alarm output will be disabled.

### Safety mode

The F124 has a safety mode that keeps on transmitting a pre-defined value as long as the contact is made. After releasing the contact, the former value and function will be reinstalled.

### Communication

All process data and settings can be read and modified manually or through the Modbus communication link (RS232 / RS485). Full Modbus functionality remains available for the Intrinsically Safe version (TTL).

### Hazardous areas

This model has been ATEX and IECEx certified Intrinsically Safe for gas and dust applications, with an allowed ambient temperature of -40°C to +70°C (-40°F to +158°F).

A flame proof enclosure with ATEX certification offers the rating  $\text{Ex II 2 GD EEx d IIB T5}$ .

### Enclosures

All enclosures are ATEX and IECEx approved. As standard the F124 is supplied in an GRP panel mount enclosure, which can be converted to an IP67 / NEMA 4X GRP field mount enclosure by the addition of a back case. Most popular is our rugged aluminum field mount enclosure.

## Overview application F124

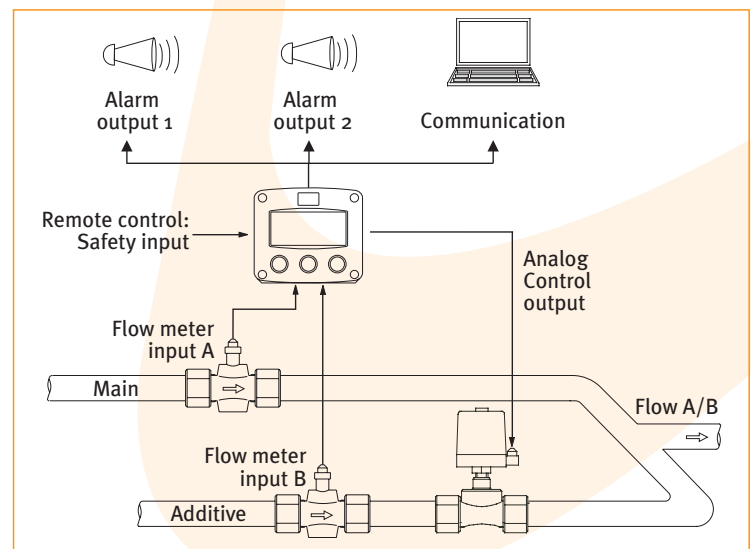

# Dimensions enclosures

## Aluminum & GRP panel mount enclosure

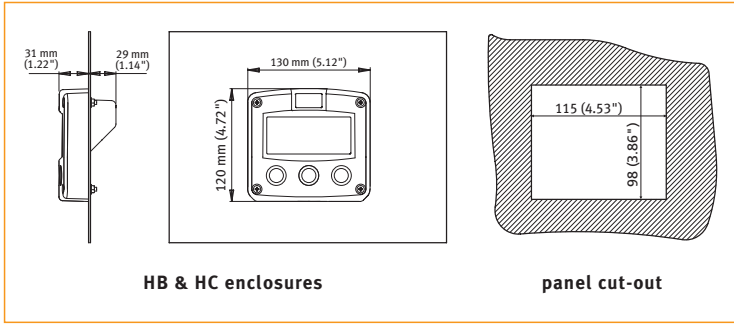

HB & HC enclosures

panel cut-out

## Aluminum & GRP field / wall mount enclosures

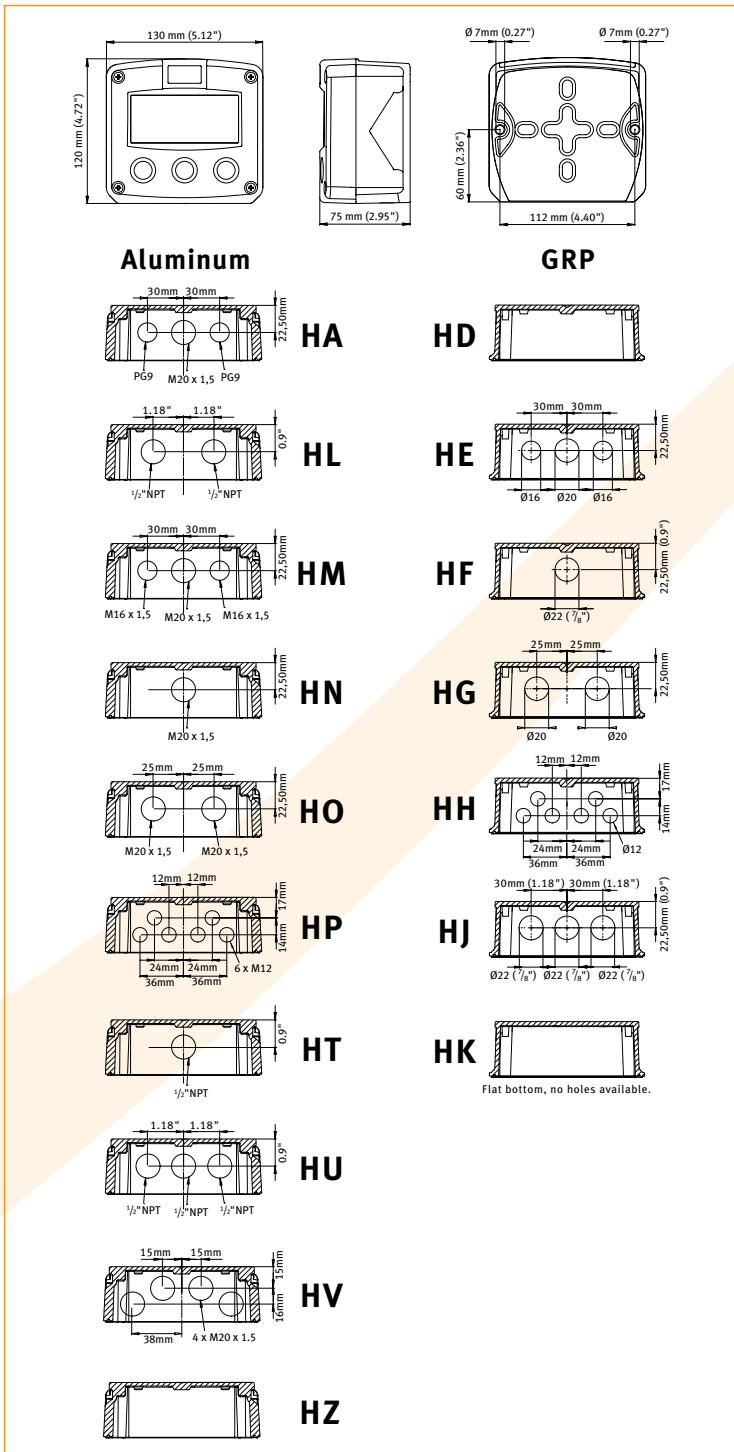

Aluminum

GRP

# Terminal connections

|                    |    |    |    |    |    |    |    |    |    |    |    |    |    |    |    |                  |    |              |    |         |    |                      |   |       |   |                   |   |                     |   |                           |  |              |  |             |  |       |  |       |  |            |  |       |  |       |  |                  |  |   |  |   |  |                        |  |   |  |   |  |
|--------------------|----|----|----|----|----|----|----|----|----|----|----|----|----|----|----|------------------|----|--------------|----|---------|----|----------------------|---|-------|---|-------------------|---|---------------------|---|---------------------------|--|--------------|--|-------------|--|-------|--|-------|--|------------|--|-------|--|-------|--|------------------|--|---|--|---|--|------------------------|--|---|--|---|--|
| 31                 | 30 | 29 | 28 | 27 | 26 | 25 | 24 | 23 | 22 | 21 | 20 | 19 | 18 | 17 | 16 | 15               | 14 | 13           | 12 | 11      | 10 | 9                    | 8 | 7     | 6 | 5                 | 4 | 3                   | 2 | 1                         |  |              |  |             |  |       |  |       |  |            |  |       |  |       |  |                  |  |   |  |   |  |                        |  |   |  |   |  |
| COMMUNICATION      |    |    |    |    |    |    |    |    |    |    |    |    |    |    |    | CR RS232         |    | DTR +12V TXD |    | RXD TXD |    | CI RS485 - 2 wire    |   | A B   |   | CI RS485 - 4 wire |   | A B Y Z             |   | CT TTL Intrinsically Safe |  | DTR +12V TXD |  | RXD TXD     |  |       |  |       |  |            |  |       |  |       |  |                  |  |   |  |   |  |                        |  |   |  |   |  |
| ADDITIONAL INPUT   |    |    |    |    |    |    |    |    |    |    |    |    |    |    |    | Safety input     |    | +            |    | +       |    | +                    |   | +     |   | +                 |   | +                   |   | +                         |  | +            |  | +           |  | +     |  |       |  |            |  |       |  |       |  |                  |  |   |  |   |  |                        |  |   |  |   |  |
| FLOW-METER INPUT B |    |    |    |    |    |    |    |    |    |    |    |    |    |    |    | P coil           |    | ~            |    | ~       |    | P. reed switch / NPN |   | +     |   | +                 |   | +                   |   | +                         |  | +            |  | +           |  | +     |  | +     |  | +          |  | +     |  |       |  |                  |  |   |  |   |  |                        |  |   |  |   |  |
| FLOW-METER INPUT A |    |    |    |    |    |    |    |    |    |    |    |    |    |    |    | P coil           |    | ~            |    | ~       |    | P. reed switch / NPN |   | +     |   | +                 |   | +                   |   | +                         |  | +            |  | +           |  | +     |  | +     |  | +          |  | +     |  | +     |  |                  |  |   |  |   |  |                        |  |   |  |   |  |
| ANALOG OUTPUT      |    |    |    |    |    |    |    |    |    |    |    |    |    |    |    | AA-4 - 20mA      |    | I+ I-        |    | I+ I-   |    | AB-0 - 20mA          |   | I+ I- |   | I+ I-             |   | AF-4 - 20mA         |   | I- I+                     |  | I+ I-        |  | AI-4 - 20mA |  | I+ I- |  | I+ I- |  | AU-0 - 10V |  | U+ U- |  | U+ U- |  |                  |  |   |  |   |  |                        |  |   |  |   |  |
| ALARM OUTPUT 1     |    |    |    |    |    |    |    |    |    |    |    |    |    |    |    | OA active 24V DC |    | +            |    | +       |    | OT positive fault    |   | +     |   | +                 |   | OR mech. relay      |   | =                         |  | =            |  | =           |  | =     |  | =     |  | =          |  | =     |  | =     |  |                  |  |   |  |   |  |                        |  |   |  |   |  |
| ALARM OUTPUT 2     |    |    |    |    |    |    |    |    |    |    |    |    |    |    |    | OA active 24V DC |    | +            |    | +       |    | OT positive fault    |   | +     |   | +                 |   | OR mech. relay      |   | =                         |  | =            |  | =           |  | =     |  | =     |  | =          |  | =     |  | =     |  |                  |  |   |  |   |  |                        |  |   |  |   |  |
| POWER REQUIREMENTS |    |    |    |    |    |    |    |    |    |    |    |    |    |    |    | PD-8 - 24V AC    |    | ~            |    | ~       |    | PD-8 - 24V DC        |   | +     |   | +                 |   | PD-XI - 15 - 30V DC |   | +                         |  | +            |  | PF-24V AC   |  | ~     |  | ~     |  | PF-24V DC  |  | +     |  | +     |  | PM-115 - 230V AC |  | ~ |  | ~ |  | PXZB: Backlight supply |  | - |  | + |  |

(With PD / PF / PM terminals 1/2 are not available, backlight power supply is integrated)

PX: 8 - 30V DC  
Output loop covered unit with type AP (terminals GND-1, -2 are not available)

PS: PC, battery powered  
Power source: battery  
(terminals GND-1, -2 are not available)

## Display example - 90 x 40mm (3.5" x 1.6")



Typical wiring diagram F124-A-AP-CH-OT-PX

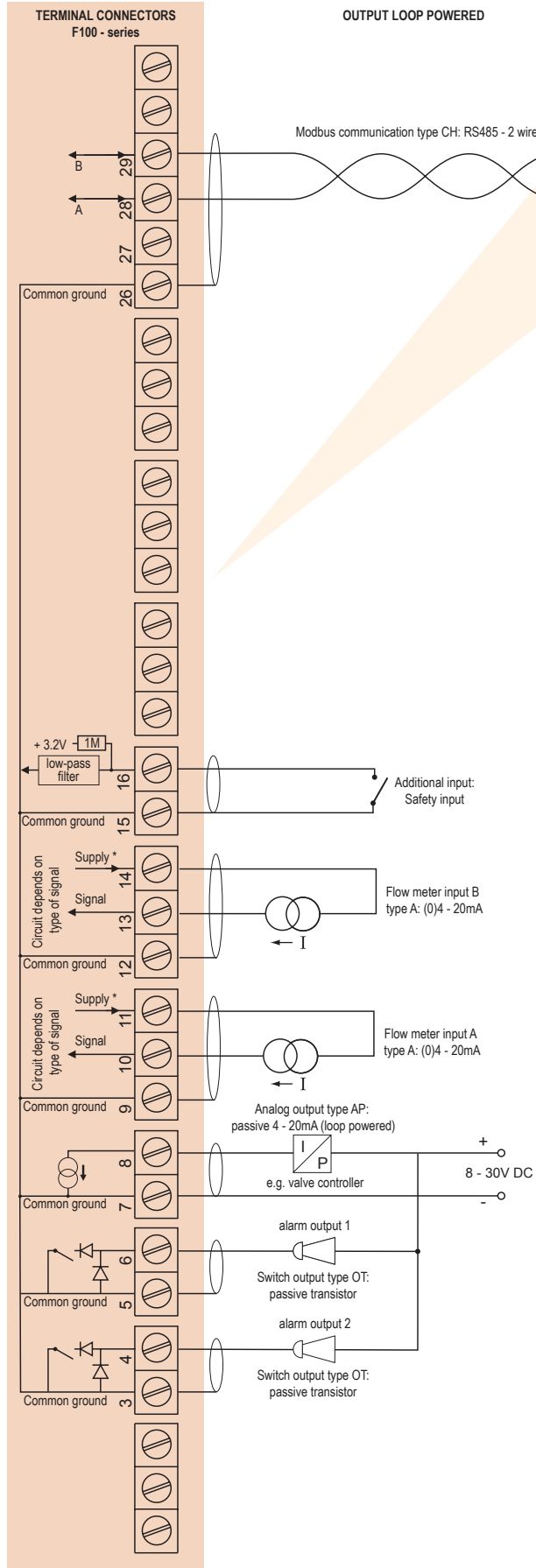

\*Supply voltage: 1.2 / 3.2V DC to sensor

Typical wiring diagram F124-P-AP-CH-PF

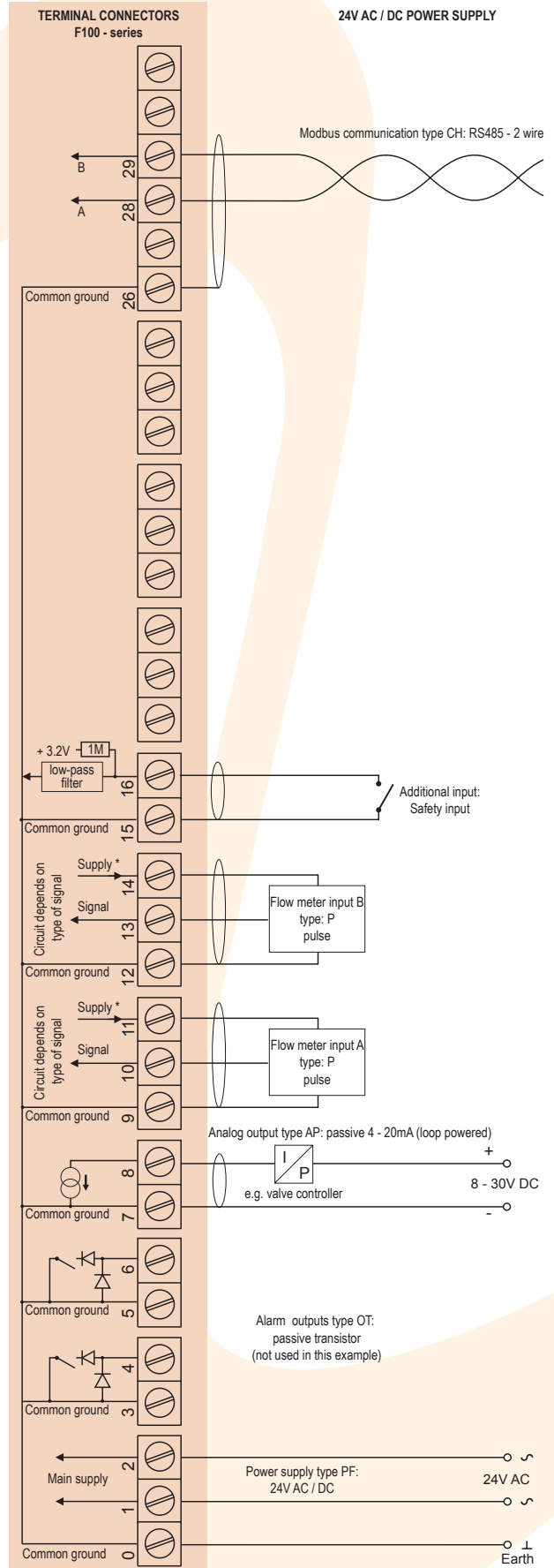

\*Supply voltage: 1.2 / 3.2 / 8.2 / 12 / 24V DC to sensor

Typical wiring diagram F124-P-AA-CB-OA-PD

Typical wiring diagram F124-A-AI-CI-OR-PM

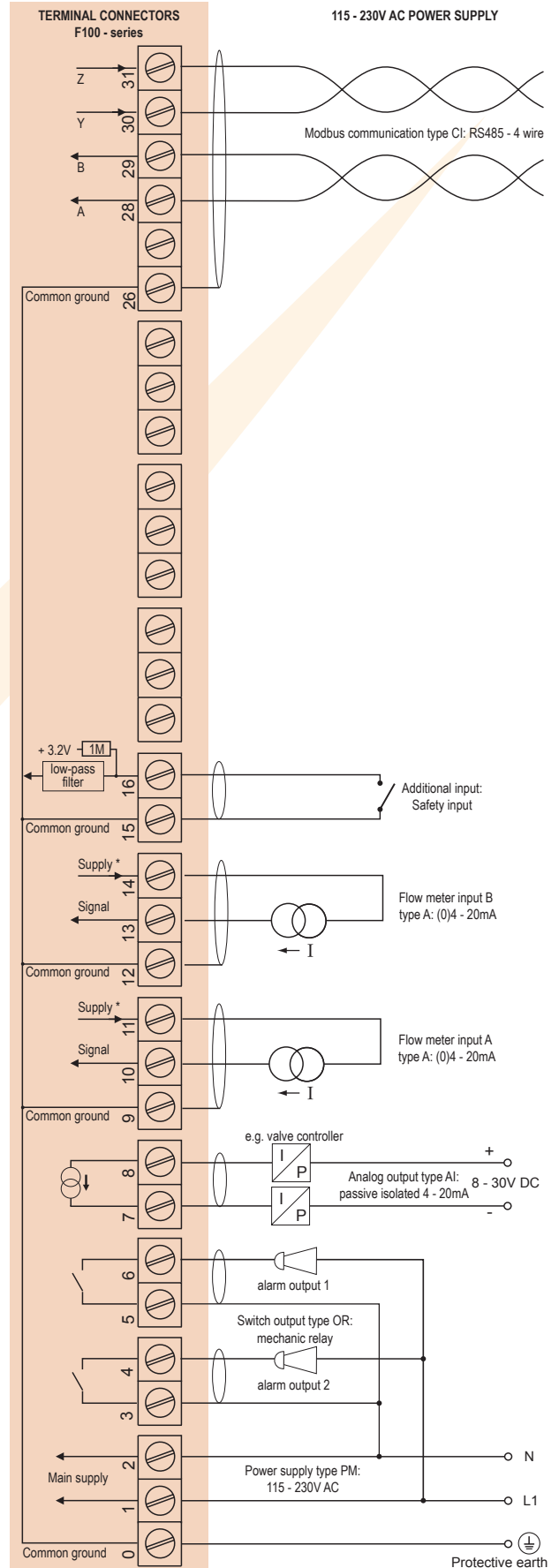
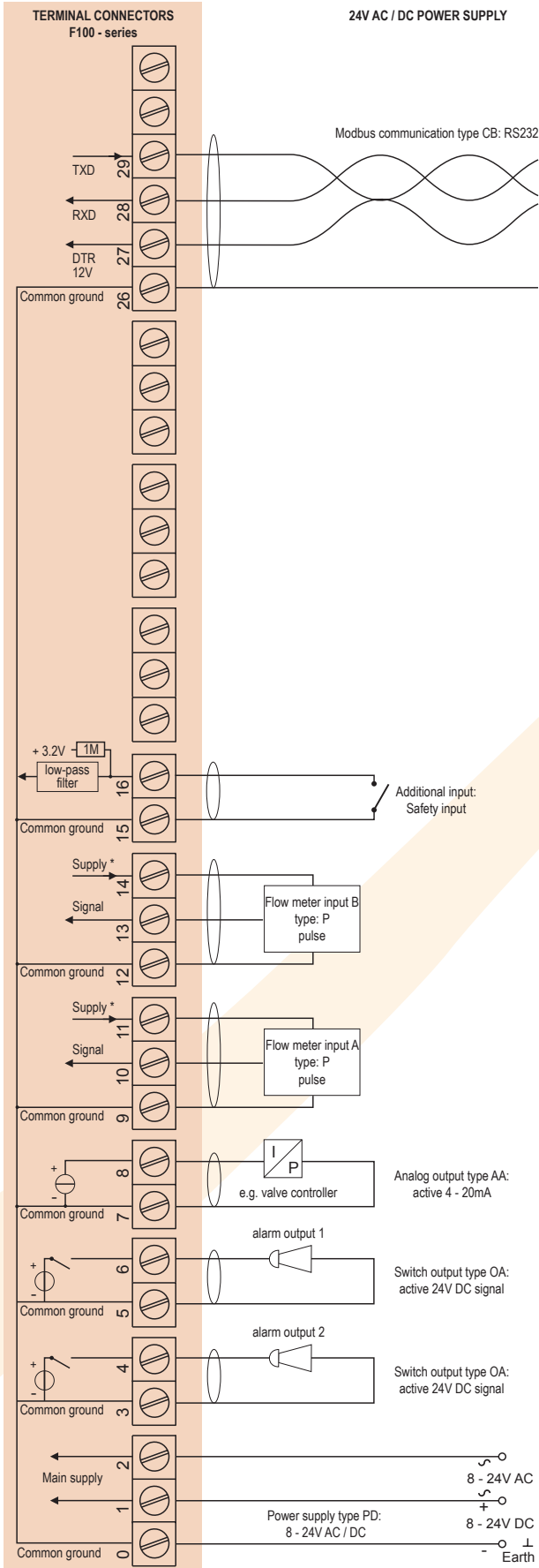

\*Supply voltage: 1.2 / 3.2 / 8.2 / 12 / 24V DC to sensor

\*Supply voltage: 1.2 / 3.2 / 8.2 / 12 / 24V DC to sensor

## Hazardous area applications

The F124-XI has been certified according ATEX and IECEx by DEKRA for use in Intrinsically Safe applications with an ambient temperature of -40°C to +70°C (-40°F to +158°F).

- The ATEX markings for gas and dust applications are:

**II 1 G Ex ia IIB/IIC T4 Ga**  
**II 1 D Ex ia IIIC T100 °C Da IP6X.**

- The IECEx markings for gas and dust applications are: **Ex ia IIC/IIB T4 Ga** and **Ex ia IIIC T100 °C Da IP6X.**

It is allowed to connect up to six barriers in IIB/IIIC applications or one barrier in IIC applications. Consult the certificate for the maximum input and output values of the circuits. Full functionality of the F124 remains available, including 8.2V sensor excitation for e.g. Namur sensors (type PD) and the Modbus communication type CT. A flame proof enclosure is available as well with rating ATEX **II 2 GD EEx d IIB T5**. Please contact your supplier for further details.

## Certificate of conformity KEMA 03ATEX1074 X • IECEx DEK 11.0042X

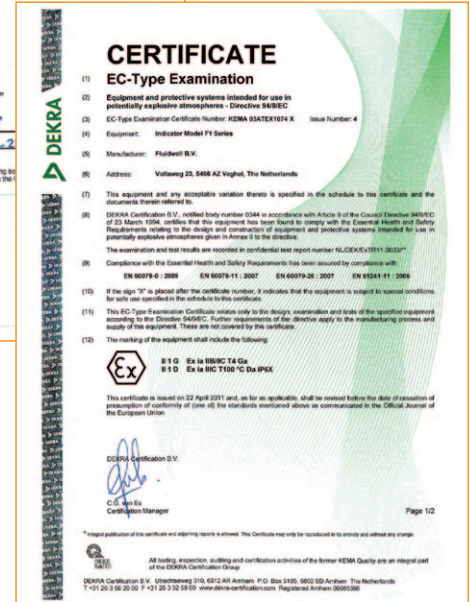
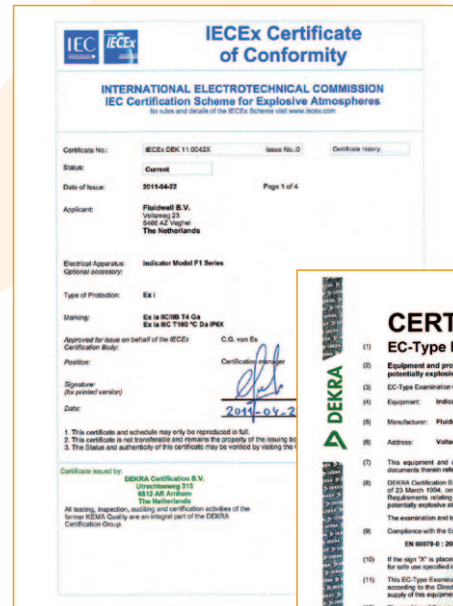

## Configuration example IIB / IIIC and IIC - F124-P-AP-OT-PX-XI - Output loop powered unit

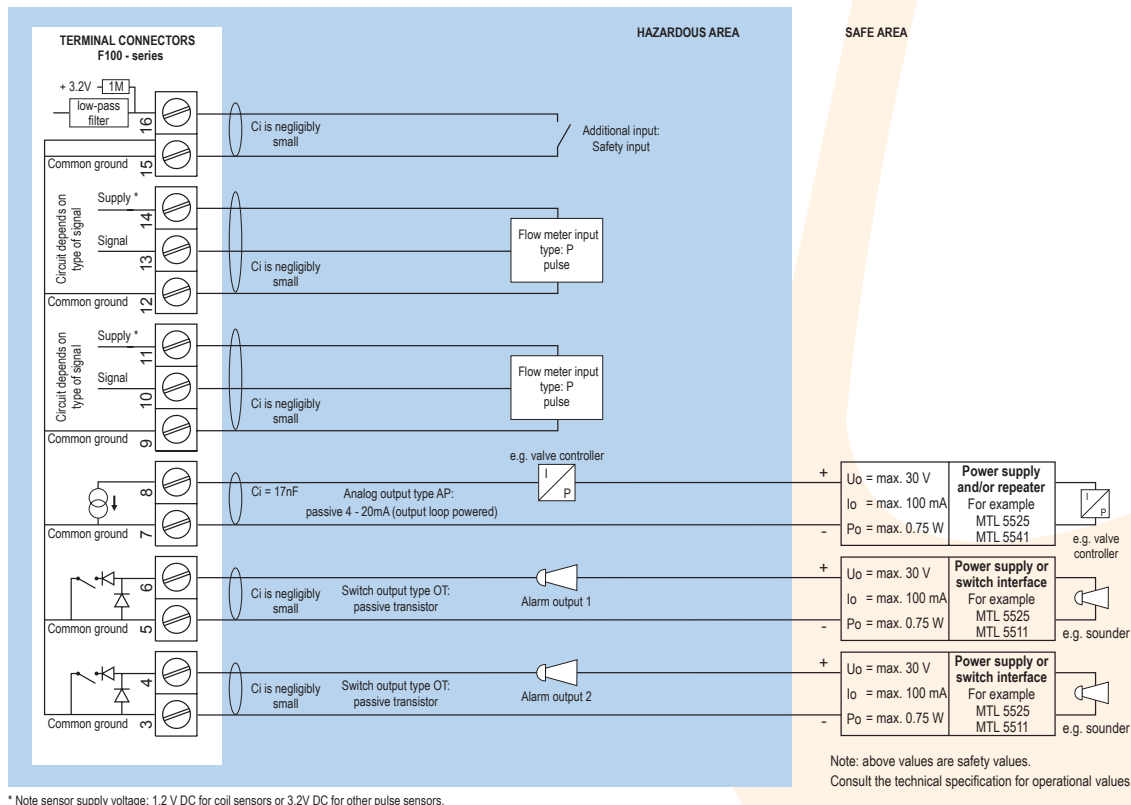

## Configuration example IIB / IIIC - F124-A-AP-CT-OT-PX-XI - Output loop powered unit

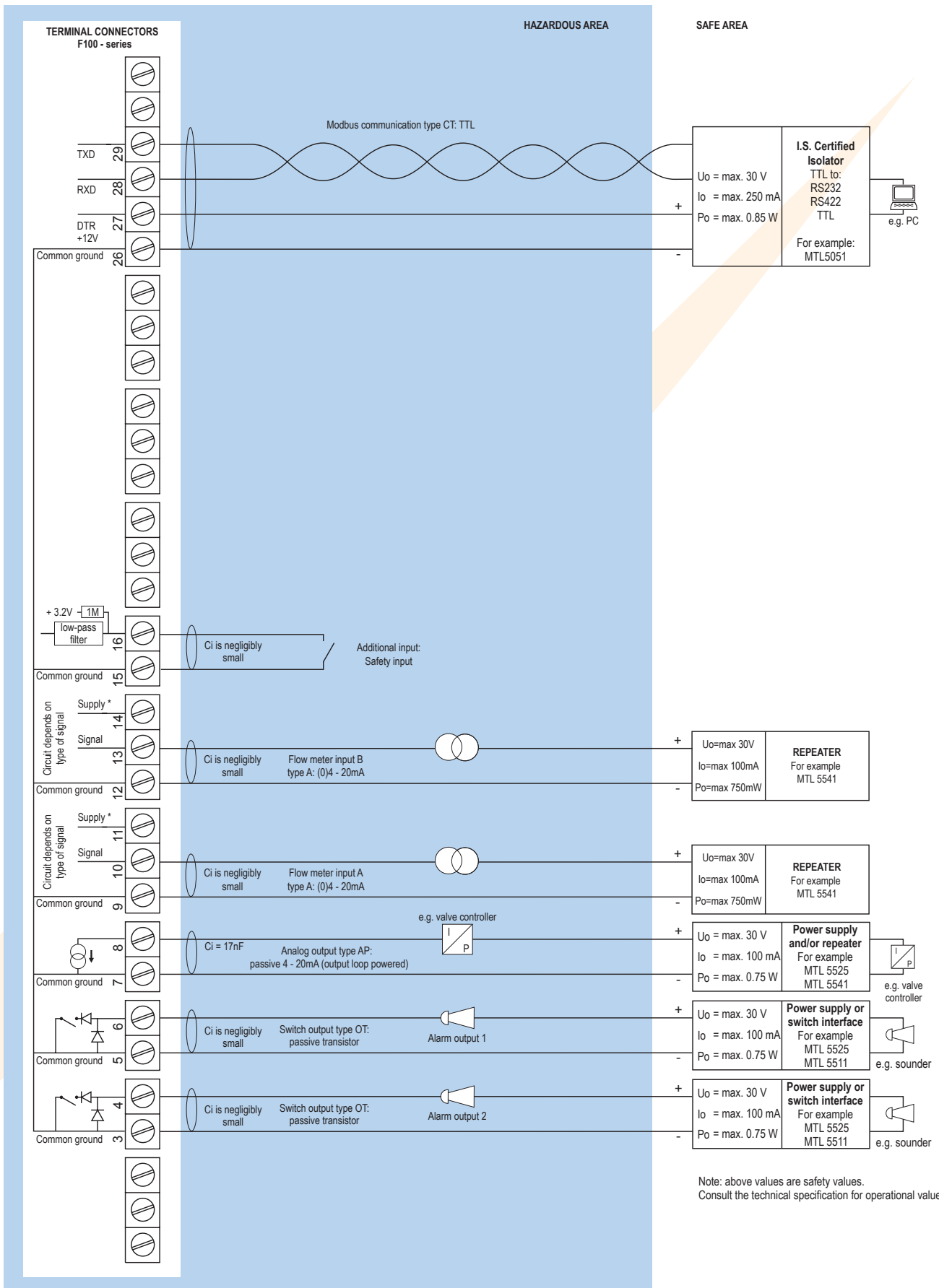

## Configuration example IIB / IIIC and IIC - F124-A-AP-CT-OT-PD-XI - Power requirement 16 - 30V DC

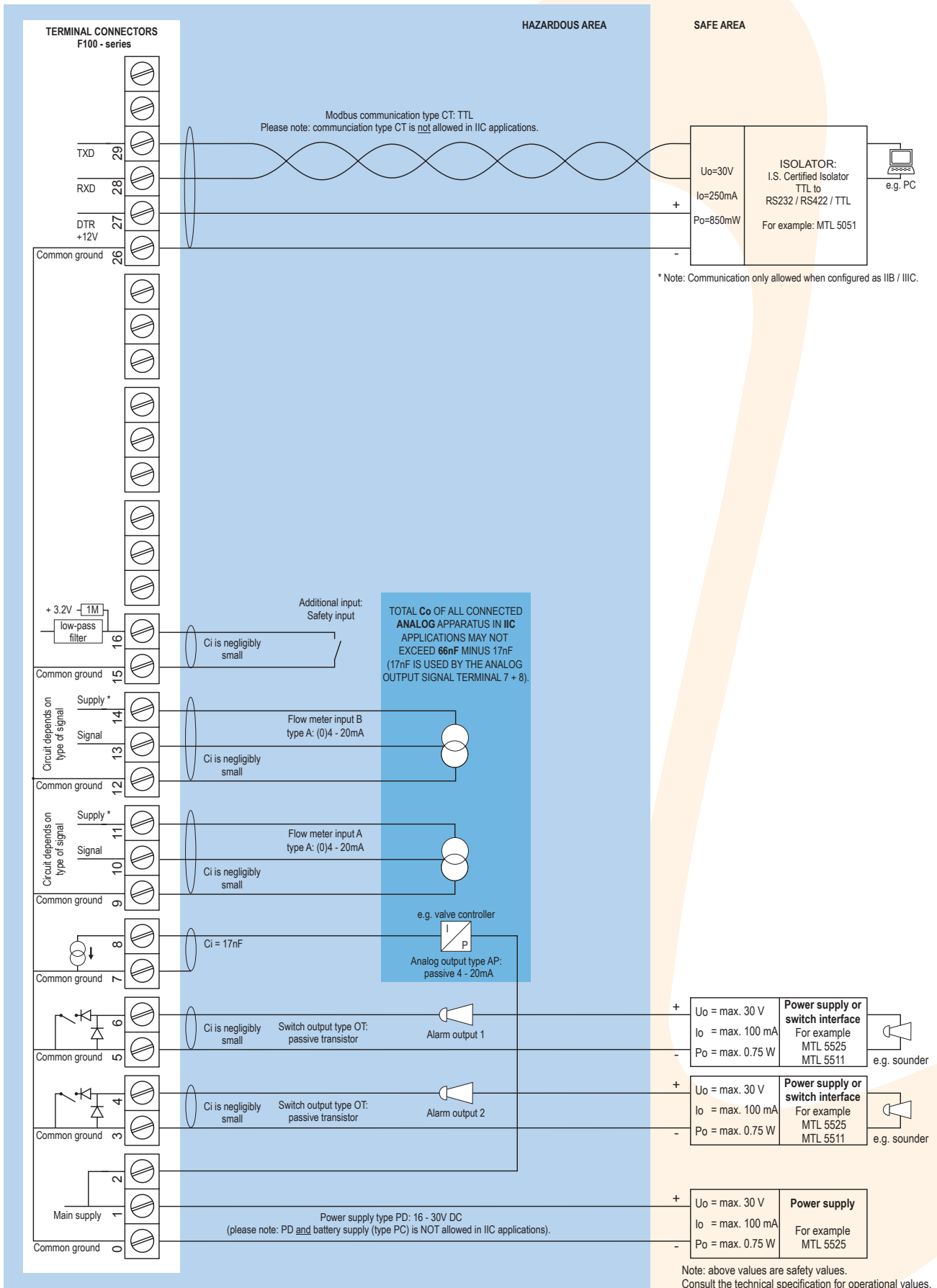

\* Note power supply type PD: the supply voltage to pulse sensors is maximum 8.7V (U<sub>o</sub>=max 8.7V I<sub>o</sub>=max 25mA P<sub>o</sub>=max 150mW) and to analog sensors as connected to terminal 1 (internally linked).



## Configuration example IIB / IIIC - F124-P-AF-CT-OT-PD-XI - Power requirement 16 - 30V DC

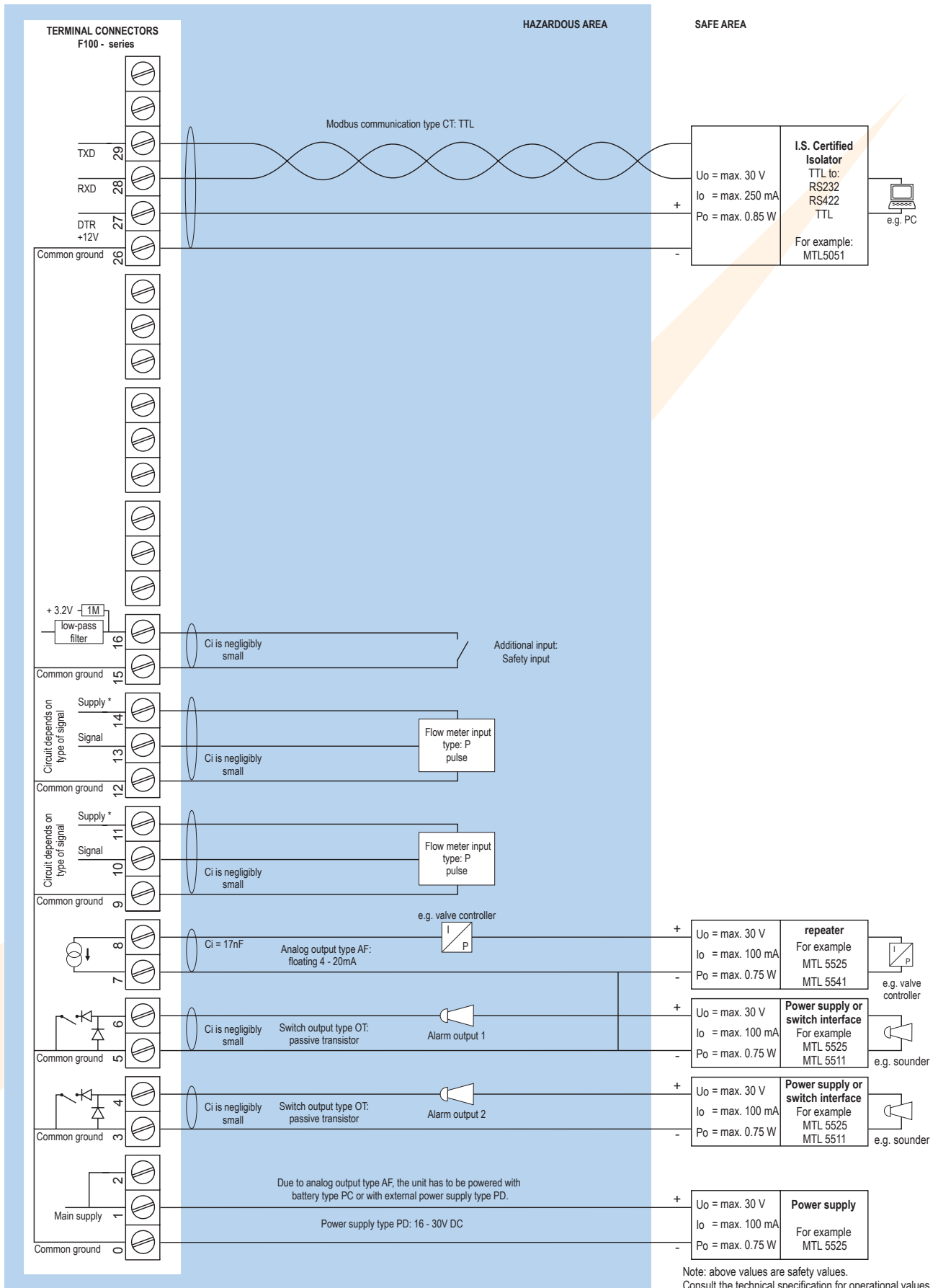

\* Note power supply type PD: the supply voltage to pulse sensors is maximum 8.7V ( $U_o = \max. 8.7\text{ V}$   $I_o = \max. 25\text{ mA}$   $P_o = \max. 150\text{ mW}$ ) and to analog sensors as connected to terminal 1 (internally linked).

## Technical specification

### General

| Display      |   |
|--------------|---|
| Type         | High intensity reflective numeric and alphanumeric LCD, UV-resistant.                               |
| Dimensions   | 90 x 40mm (3.5" x 1.6").  |
| Digits       | Seven 17mm (0.67") and eleven 8mm (0.31") digits. Various symbols and measuring units.              |
| Refresh rate | User definable: fast, 1sec, 3sec, 15sec, 30sec, off.  |
| Option ZB    | Transflective LCD with adjustable green LED backlight. Good readings in full sunlight and darkness. |
| Note ZB      | Only available for safe area applications.  |

### Ambient temperature

|                    |                                   |
|--------------------|-----------------------------------|
| Safe areas         | -40°C to +80°C (-40°F to +176°F). |
| Intrinsically Safe | -40°C to +70°C (-40°F to +158°F). |

### Power requirements

|               |   |
|---------------|---|
| Type PB       | Long life Lithium battery - life-time depends upon settings and configuration - up to 5 years.                            |
| Type PC       | Intrinsically Safe long life lithium battery - life-time depends upon settings and configuration - up to 5 years.         |
| Type PD       | 8 - 24V AC / DC ± 10%. Power consumption max. 10 Watt. Intrinsically Safe: 16 - 30V DC; power consumption max. 0.75 Watt. |
| Type PF       | 24V AC / DC ± 10%. Power consumption max. 15 Watt.  |
| Type PM       | 115 - 230V AC ± 10%. Power consumption max. 15 Watt.  |
| Type PX       | 8 - 30V DC. Power consumption max. 0.5 Watt.  |
| Type ZB       | 12 - 24V DC ± 10% or internally powered with type PD / PF / PM. Power consumption max. 1 Watt.                            |
| Note PB/PF/PM | Not available Intrinsically Safe.   |
| Note PF/PM    | The total consumption of the sensors and outputs may not exceed 400mA @ 24V.  |
| Note          | For Intrinsically Safe applications, consult the safety values in the certificate.  |

### Sensor excitation

|               |   |
|---------------|---|
| Type PB/PC/PX | 3.2V DC for pulse signals and 1.2V DC for coil pick-up.   |
| Note          | This is not a real sensor supply. Only suitable for sensors with a very low power consumption like coils (sine wave) and reed-switches.                               |
| Type PD       | 1.2 / 3.2 / 8.2 / 12 / 24V DC - max. 50mA @ 24V DC.   |
| Type PD-XI    | 1.2 / 3.2 / 8.2V DC - max. 7mA @ 8.2V DC and mains power supply voltage (as connected to terminal 1).   |
| Note          | In case PD-XI and signal A or U: the sensor supply voltage is according to the power supply voltage connected to terminal 1. Also terminal 2 offers the same voltage. |
| Type PF / PM  | 1.2 / 3.2 / 8.2 / 12 / 24V DC - max. 400mA @ 24V DC.  |

### Terminal connections

|      |  |
|------|--|
| Type | Removable plug-in terminal strip.<br>Wire max. 1.5mm <sup>2</sup> and 2.5mm <sup>2</sup> . |
|------|--|

### Data protection

|          |  |
|----------|--|
| Type     | EEPROM backup of all settings. Data retention at least 10 years. |
| Password | Configuration settings can be password protected.                |

### Directives & Standards

|              |   |
|--------------|---|
| EMC          | Directive 2004/108/EC, FCC 47 CFR part 15.                  |
| Low voltage  | Directive 2006/95/EC  |
| ATEX / IECEx | Directive 94/9/EC, IEC 60079-0, IEC 60079-11, IEC 60079-26. |
| IP & NEMA    | EN 60529 & NEMA 250   |

### Enclosure

#### General

|              |   |
|--------------|---|
| Window       | Polycarbonate window.   |
| Sealing      | Silicone.   |
| Control keys | Three industrial micro-switch keys. UV-resistant silicone keypad. |

### Aluminum wall / field mount enclosures

|            |  |
|------------|--|
| General    | Die-cast aluminum wall/field mount enclosure IP67 / NEMA 4X with 2-component UV-resistant coating. |
| Dimensions | 130 x 120 x 75mm (5.12" x 4.72" x 2.95") - W x H x D.  |
| Weight     | 1100 gr.   |
| Type HA    | Cable entry: 2 x PG9 and 1 x M20.  |
| Type HL    | Cable entry: 3 x 1/2" NPT.   |
| Type HM    | Cable entry: 2 x M16 and 1 x M20.  |
| Type HN    | Cable entry: 1 x M20.  |
| Type HO    | Cable entry: 2 x M20.  |
| Type HP    | Cable entry: 6 x M12.  |
| Type HT    | Cable entry: 1 x 1/2" NPT.   |
| Type HU    | Cable entry: 3 x 1/2" NPT.   |
| Type HV    | Cable entry: 4 x M20.  |
| Type HZ    | Cable entry: no holes.   |

### GRP wall / field mount enclosures



|            |  |
|------------|--|
| General    | GRP wall/field mount enclosure IP67 / NEMA 4X, UV-resistant and flame retardant. |
| Dimensions | 130 x 120 x 75mm (5.12" x 4.72" x 2.95") - W x H x D.                            |
| Weight     | 600 gr.  |
| Type HD    | Cable entry: no holes.   |
| Type HE    | Cable entry: 2 x Ø 16mm and 1 x Ø 20mm.  |
| Type HF    | Cable entry: 1 x Ø 22mm (7/8").  |
| Type HG    | Cable entry: 2 x Ø 20mm.   |
| Type HH    | Cable entry: 6 x Ø 12mm.   |
| Type HJ    | Cable entry: 3 x Ø 22mm (7/8").  |
| Type HK    | Flat bottom, cable entry: no holes.  |

### Panel mount enclosures

|               |   |
|---------------|---|
| Dimensions    | 130 x 120 x 60mm (5.12" x 4.72" x 2.36") - W x H x D.                       |
| Panel cut-out | 115 x 98mm (4.53" x 3.86") L x H.   |
| Type HB       | Die-cast aluminum panel mount enclosure IP65 / NEMA 4X.                     |
| Weight        | 600 gr.   |
| Type HC       | GRP panel mount enclosure IP65 / NEMA 4X, UV-resistant and flame retardant. |
| Weight        | 450 gr.   |

## Hazardous area

### Intrinsically Safe (Type XI)

|                     |   |
|---------------------|---|
| ATEX certification  |  II 1 G Ex ia IIB/IIC T4 Ga.<br>II 1 D Ex ia IIIC T100 °C Da IP6X. |
| IECEX certification |  Ex ia IIC/IIB T4 Ga.<br>Ex ia IIIC T100 °C Da IP6X.               |
| Ambient Ta          | -40°C to +70°C (-40°F to +158°F).   |

### Explosion proof (Type XF)

|                    |   |
|--------------------|---|
| ATEX certification |  II 2 GD EEx d IIB T5. |
| Dimensions         | 300 x 250 x 200mm (11.8" x 9.9" x 7.9") L x H x D.  |
| Weight             | Appr. 15kg.   |

## Signal inputs

### Flow meter

|                 |   |
|-----------------|---|
| Type P          | Coil / sine wave (HI: 20mVpp or LO: 80mVpp - sensitivity selectable), NPN/PNP, open collector, reed-switch, Namur, active pulse signals 8 - 12 and 24V DC.                              |
| Frequency       | Minimum 0Hz - maximum 7kHz for total and flow rate. Maximum frequency depends on signal type and internal low-pass filter. E.g. reed switch with low-pass filter: max. frequency 120Hz. |
| K-Factor        | 0.000010 - 9,999,999 with variable decimal position.  |
| Low-pass filter | Available for all pulse signals.  |
| Option ZF       | coil sensitivity 10mVpp.  |
| Type A          | (0)4 - 20mA. Analog input signal can be scaled to any desired range within 0 - 20mA.  |
| Type U          | 0 - 10V DC. Analog input signal can be scaled to any desired range within 0 - 10V DC.   |
| Accuracy        | Resolution: 14 bit. Error < 0.025mA / ± 0.125% FS.<br>Low level cut-off programmable.   |
| Span            | 0.000010 - 9,999,999 with variable decimal position.  |
| Update time     | Four times per second.  |
| Voltage drop    | Type A: 2.5V @ 20mA.  |
| Load impedance  | Type U: 3kOhm.  |
| Relationship    | Linear and square root calculation.   |
| Note            | For signal type A and U: external power to sensor is required; e.g. type PD.  |

### Additional input

|             |  |
|-------------|--|
| Function    | Standard available: Safety input.<br>Terminal input to activate the predefined safety ratio. |
| Description | Internally pulled-up switch contact - NPN.   |
| Duration    | Minimum pulse duration 100msec.  |

## Signal outputs

### Communication option

|            |  |
|------------|--|
| Function   | Reading display information, reading / writing all configuration settings. |
| Protocol   | Modbus RTU.  |
| Speed      | 1200 - 2400 - 4800 - 9600 baud.  |
| Addressing | Maximum 255 addresses.   |
| Type CB    | RS232  |
| Type CH    | RS485 2-wire   |
| Type CI    | RS485 4-wire   |
| Type CT    | TTL Intrinsically Safe.  |

## Analog output

|             |   |
|-------------|---|
| Function    | Controlling the ratio between flow A and B.   |
| Accuracy    | 10 bit. Error < 0.05%. Analog output signal can be scaled to any desired range.   |
| Update time | Eight times per second.   |
| Type AA     | Active 4 - 20mA output (requires PD, PF or PM).   |
| Type AB     | Active 0 - 20mA output (requires PD, PF or PM).   |
| Type AF     | Passive floating 4 - 20mA output for Intrinsically Safe applications (requires XI + PC or PD).                          |
| Type AI     | Passive galvanically isolated 4 - 20mA output - also available for battery powered models (requires PB, PD, PF, or PM). |
| Type AP     | Passive 4 - 20mA output - not isolated. Unit will be loop powered.  |
| Type AU     | Active 0 - 10V DC output (requires PD, PF or PM).   |

## Digital outputs

|          |  |
|----------|--|
| Function | Low or high ratio alarm output.<br>Alarm value limits: 0 - 100%.   |
| Type OA  | Two active 24V DC transistor outputs (PNP); max. 50mA per output (requires PD, PF or PM).                    |
| Type OR  | Two electro-mechanical relay outputs isolated (N.O.) - max. switch power 230V AC - 0.5A (requires PF or PM). |
| Type OT  | Two passive transistor outputs (NPN) - not isolated. Max. 50V DC - 300mA per output.                         |

## Operational

### Operator functions

|                     |   |
|---------------------|---|
| Displayed functions | <ul style="list-style-type: none"> <li>Ratio setpoint in %.</li> <li>Actual ratio in %.</li> <li>Flowrate A</li> <li>Flowrate B</li> <li>Low ratio alarm value.</li> <li>High ratio alarm value.</li> <li>Operation modes: Hand, Local or Ratio.</li> <li>Safety mode.</li> </ul> |
|---------------------|---|

### Flowrate

|            |   |
|------------|---|
| Digits     | 7 digits.   |
| Units      | mL, L, m³, Gallons, kg, Ton, lb, bl, cf, RND, ft³, scf, Nm³, NL, igal - no units. |
| Decimals   | 0 - 1 - 2 or 3.   |
| Time units | /sec - /min - /hr - /day.   |

### Control Parameters



|                        |   |
|------------------------|---|
| Operation mode         | Hand, Local, Ratio.                             |
| Control action         | Direct / Reverse.                               |
| Proportional band      | 0.1 to 999,9%.                                  |
| Integral time          | 0.1 to 6,000.0 s or OFF (0.0).                  |
| Safety output          | -5.0 to 105.0% (0) = Run / (1) = Safety output. |
| Control output limiter | -5.0 to 105.0% for both high and low limits.    |

## Ordering information



Standard configuration: F124-P-AP-CX-EX-HC-IX-OT-PX-TX-XX-ZX.

Ordering information: F124 \_ -A \_ -C \_ -EX -H \_ -IX -O \_ -P \_ -TX -X \_ -Z \_



### Flow meter input signal

- A  (0)4 - 20mA input.
- P  **Pulse input: coil, npn, pnp, namur, reed-switch.**
- U  0 - 10V DC input.

### Analog output signal

- AA Active 4 - 20mA output - requires PD, PF or PM.
- AB Active 0 - 20mA output - requires PD, PF or PM.
- AF  I.S. floating 4 - 20mA output - requires XI + PC or PD.
- AI Isolated 4 - 20mA output - requires PB, PD, PF or PM.
- AP  **Passive 4 - 20mA output, loop powered unit.**
- AU Active 0 - 10V DC output - requires PD, PF or PM.



### Communication

- CB Communication RS232 - Modbus RTU.
- CH Communication RS485 - 2-wire - Modbus RTU.
- CI Communication RS485 - 4-wire - Modbus RTU.
- CT  Intrinsically Safe TTL - Modbus RTU.
- CX  **No communication.**







### Flow equations

- EX  **No flow equations.**











### Panel mount enclosures - IP65 / NEMA4X

- HB  Aluminum enclosure.
- HC  GRP enclosure.

### GRP field / wall mount enclosures - IP67 / NEMA4X

- HD  Cable entry: no holes.
- HE  Cable entry: 2 x Ø 16mm & 1 x Ø 20mm.
- HF  Cable entry: 1 x Ø 22mm (7/8").
- HG  Cable entry: 2 x Ø 20mm.
- HH  Cable entry: 6 x Ø 12mm.
- HJ  Cable entry: 3 x Ø 22mm (7/8").
- HK  Flat bottom, cable entry: no holes.

### Aluminum field / wall mount enclosures - IP67 / NEMA4X

- HA  Cable entry: 2 x PG9 + 1 x M20.
- HL  Cable entry: 2 x 1/2" NPT.
- HM  Cable entry: 2 x M16 + 1 x M20.
- HN  Cable entry: 1 x M20.
- HO  Cable entry: 2 x M20.
- HP  Cable entry: 6 x M12.
- HT  Cable entry: 1 x 1/2" NPT.
- HU  Cable entry: 3 x 1/2" NPT.
- HV  Cable entry: 4 x M20.
- HZ  Cable entry: no holes.



### Additional input signal

- IX  **No additional input - Safety input is standard available.**

### Digital output signals

- OA Two active transistor outputs - requires PD, PF or PM.
- OR Two mechanical relay outputs - requires PF or PM.
- OT  **Two passive transistor outputs - standard configuration.**

### Power requirements

- PB Lithium battery powered.
- PC  Lithium battery powered - Intrinsically Safe.
- PD  8 - 24V AC/DC + sensor supply - with XI: 16 - 30V DC.
- PF 24V AC/DC + sensor supply.
- PM 115 - 230V AC + sensor supply.
- PX  **Basic power supply 8 - 30V DC (no real sensor supply). Unit requires external loop AP.**



### Temperature input signal

- TX  **No temperature input signal.**

### Hazardous area

- XI  Intrinsically Safe, according ATEX and IECEx.
- XF EExd enclosure - 3 keys.
- XX **Safe area only.**

### Other options

- ZB Adjustable backlight.
- ZF  Coil input 10mVpp.
- ZX  **No options.**

The bold marked text contains the standard configuration.

 Available Intrinsically Safe.

Specifications are subject to change without notice.



Quality  
ISO 9001

www.dekra-seal.com

Fluidwell bv

P.O. Box 6  
5460 AA - Veghel - The Netherlands  
Telephone: +31 (0)413 343 786  
Telefax: +31 (0)413 363 443  
email: displays@fluidwell.com  
Internet: www.fluidwell.com

