

INLINE flowmeter with paddle wheel, ELEMENT design



- Size of measurement pipes: DN06 to DN65
- Configurable outputs: one or two transistor output(s) and single or dual 4...20 mA analog output(s)
- Removable backlit display/configuration module for indication of flow rate and volume with two flow totalizers
- Automatic calibration using Teach-In, all outputs can be checked without the need of actual flow

Type 8036 can be combined with...



Type 8619
multiCELL
transmitter/controller



Type 8611
Universal process
controller eCONTROL

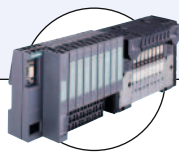

Type 8644
Valve islands

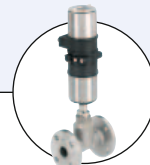

Type 2101 (8692)
ELEMENT control
valve system



Type 2030
On/Off diaphragm
valve

The Bürkert flowmeter Type 8036 is a compact device, specially designed for measuring the flow rate in solid-free liquids, in a variety of applications (water, waste water monitoring, chemical processing etc.).

Type 8036 is available with:

- 2 configurable outputs: one transistor output (NPN) and one 4...20 mA current output (2-wire)
- 3 configurable outputs: two transistor outputs (NPN/PNP) and one 4...20 mA current output (2-wire)
- 4 configurable outputs: two transistor outputs (NPN/PNP) and two 4...20 mA current outputs (3-wire).

Type 8036 converts the measured signal, displays different values in different units (if display/configuration module mounted) and computes the output signals, which are provided via one or two M12 fixed connectors. Thanks to 1 or 2 transistor outputs, the flowmeter can be used to switch a solenoid valve, activate an alarm and, thanks to 1 or 2 current outputs, establish one or two control loops.

General data	
Compatibility	Any pipe from DN06...DN65 which are fitted out with Bürkert INLINE sensor-fitting S030 (see corresponding datasheet)
Materials	See exploded view, on next page
Housing	Stainless steel 1.4404, PPS
Cover	PC
Seals	EPDM, silicone
Screws	Stainless steel
Fixed connector mounting plate	Stainless steel 1.4404 (316L)
Fixed connector	Brass nickel plated (stainless steel on request)
Display	PC
Navigation key	PBT
Quarter turn system	PC
Wetted parts	
Sensor-fitting, sensor armature	Brass, stainless steel 1.4404/316L, PVC, PP or PVDF
Seal	FKM or EPDM (depending on S030 version)
Axis and bearings	Ceramics (Al ₂ O ₃)
Paddle wheel	PVDF
Display (accessories)	Grey dot matrix 128 x 64 with backlighting
Electrical connections	
2 or 3 outputs transmitter	1 x 5-pin M12 male fixed connector
4 outputs transmitter	1 x 5-pin M12 male and 1 x 5-pin M12 female fixed connectors
Connection cable	Shielded cable
Environment	
Ambient temperature	-10...+60°C (+14...+140°F) (operating and storage)
Relative humidity	≤ 85%, without condensation

8036 / SE36 ELEMENT

bürkert

Complete device data (Sensor-fitting S030 + transmitter SE36)	
Pipe diameter	DN06...DN65
Measuring range	0.3...10 m/s
Medium temperature with sensor-fitting in PVC/ PP PVDF, brass or stainless steel	0...+50°C (+32...+122°F) / 0...+80°C (+32...+176°F) -15...+100°C (+5...+212°F)
Medium pressure max.	PN10 (145 PSI) (with plastic sensor-fitting) - PN16 (232 PSI) (with metal sensor-fitting) - (PN40 on request, see S030 datasheet) - see pressure/temperature chart
Viscosity / Particles rate	300 cSt max. / 1% max.
Measurement deviation ²⁾ Teach-In Standard K-factor	±1% of the measured value (at Teach-In flow rate value) ¹⁾ ±2.5% of the measured value ¹⁾
Linearity	±0.5% of F.S.* ¹⁾
Repeatability	±0.4% of the measured value ¹⁾
Electrical data	
Power supply 2 or 3 outputs transmitter (2-wire) 4 outputs transmitter (3-wire)	14...36 V DC, filtered and regulated 12...36 V DC, filtered and regulated
Characteristics of the power source (not provided) of UL recognized devices	Limited power source (according to § 9.4 of the UL61010-1 standard) or, Class 2 type power source (according to the 1310/1585 and 60950-1 standards)
Current consumption with sensor 2 or 3 outputs transmitter (2-wire) 4 outputs transmitter (3-wire)	≤ 1 A (with transistors load) ≤ 25 mA (at 14 V DC without transistors load, with current loop) ≤ 5 mA (at 12 V DC without transistors load, without current loop)
Power consumption	40 W max.
Protection	Reversed polarity of DC: protected Voltage peak: protected Short circuit: protected for transistor outputs
Output Transistor 1 transistor output (transmitter 2-wire) 2 transistor outputs (transmitter 2 or 3-wire) Current 1 current output (transmitter 2-wire) 2 current outputs (transmitter 3-wire)	NPN, open collector, 1...36 V DC, max. 700 mA Adjustable as sourcing or sinking (respectively both as PNP or NPN), open collector, max. 700 mA, 0.5 A max. per transistor if the 2 transistor outputs are wired NPN-output: 1...36 V DC PNP-output: Power supply 4...20 mA adjustable as sourcing or sinking (in the same mode as transistor), max. loop impedance: 1100 Ω at 36 V DC ; 610 Ω at 24 V DC; 180 Ω at 14 V DC max. loop impedance: 1100 W at 36 V DC; 610 Ω at 24 V DC; 100 Ω at 12 V DC
4...20 mA output uncertainty	±1%
Standards, directives and certifications	
Protection class	IP65, IP67 (according to EN60529) with device wired and M12 cable plug mounted and tightened and cover fully screwed down
Standards and directives CE	The applied standards, which verify conformity with the EU Directives, can be found on the EU Type Examination Certificate and/or the EU Declaration of conformity (if applicable)
Pressure	Complying with article 4, §1 of 2014/68/EU directive*
Certification UL-Recognized for US and Canada 	UL61010-1 + CAN/CSA-C22.2 No.61010-1

¹⁾ Under reference conditions i.e. measuring fluid = water, ambient and water temperature = 20°C (68°F), while maintaining the minimum inlet and outlet distances and the appropriate internal diameter of the pipes.

* F.S. = Full scale (10 m/s)

²⁾ = "measurement bias" as defined in the standard JCGM 200:2012



If the device is mounted in a humid environment or outside, then the maximum allowed voltages are **35 V DC** instead of 36 V DC.

Pressure/temperature chart

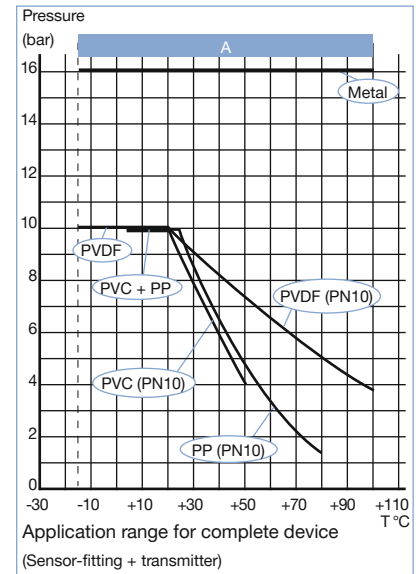

Materials view

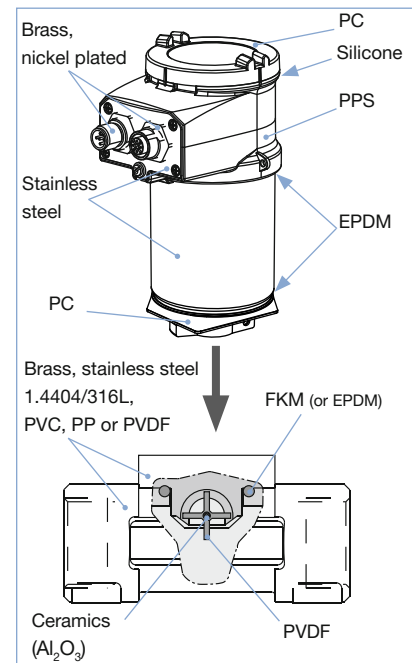

* For the 2014/68/EU pressure directive, the device can only be used under the following conditions (depends on max. pressure, pipe diameter and fluid).

Type of Fluid	Conditions
Fluid group 1, article 4, §1.c.i	DN ≤ 25
Fluid group 2, article 4, §1.c.i	DN ≤ 32 or PN*DN ≤ 1000
Fluid group 1, article 4, §1.c.ii	DN ≤ 25 or PN*DN ≤ 2000
Fluid group 2, article 4, §1.c.ii	DN ≤ 200 or PN ≤ 10 or PN*DN ≤ 5000

Design and operating principle

The device 8036 is made up of a compact INLINE sensor-fitting (S030) equipped with a sensor with paddle wheel and an enclosure with cover containing the electronic module (SE36). A removable display/configuration module completes this flowmeter. The flowmeter can operate without the display/configuration module, but it will be required for configuration of the device (i.e. set parameters, restore default parameters, enter information to be displayed, enter access codes, adjust 4...20 mA output(s) ...) and also for visualizing continuously the measured and processed data.

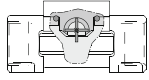

When liquid flows through the pipe, the paddle wheel with 4 inserted magnets is set in rotation, producing a measuring signal in the sensor (Hall sensor). The frequency modulated induced voltage is proportional to the flow velocity of the fluid.

A conversion coefficient (K-factor, available in the instruction manual of the S030 sensor-fitting), specific to each pipe (size and material) enables the conversion of this frequency into flow rate.

The electronic component converts the measured signal into several outputs (according to the flowmeter version) and displays the actual value. Totalizers are used to obtain the volume of fluid passed through the pipe.

Installation

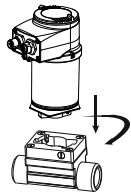

The sensor-fitting (S030) ensures simple installation into pipes from DN06...DN65. The transmitter SE36 can easily be installed into any Bürkert INLINE sensor-fitting system (S030), by means of a quarter turn.

Minimum straight upstream and downstream distances must be observed. According to the pipe's design, necessary distances can be bigger or use a flow conditioner to obtain the best accuracy. For more information, please refer to EN ISO 5167-1.

EN ISO 5167-1 prescribes the straight inlet and outlet distances that must be complied with when installing fittings in pipe lines in order to achieve calm flow conditions. The most important layouts that could lead to turbulence in the flow are shown below, together with the associated prescribed minimum inlet and outlet distances.

These ensure calm, problem-free measurement conditions at the measurement point.

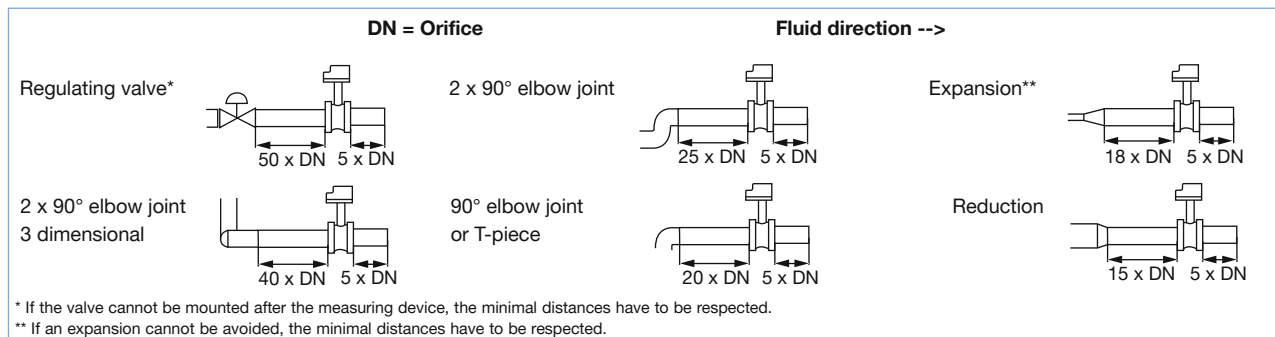

The flowmeter can be installed into either horizontal or vertical pipes.

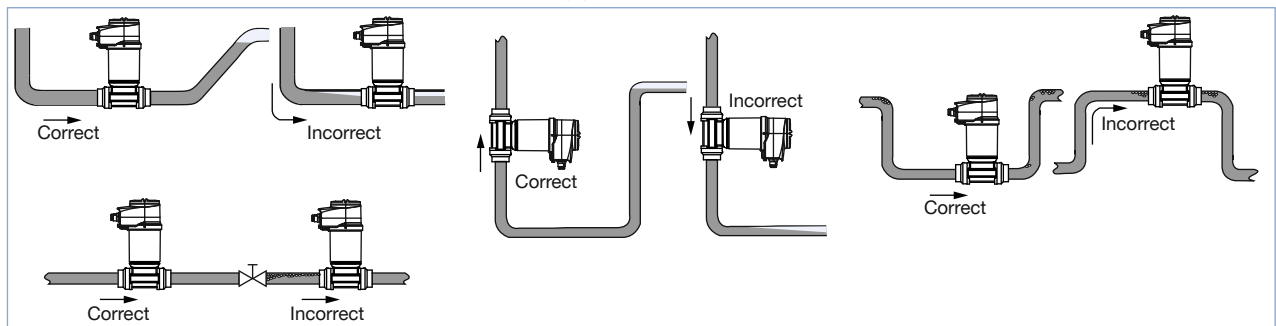

Pressure and temperature ratings must be respected according to the selected sensor-fitting material. The suitable pipe size is selected using the diagram Flow/Velocity/DN. The flowmeter is not designed for gas flow measurement.

Selection of sensor-fitting/pipe size

Example:

- Specification of nominal flow: 10 m³/h
- Ideal flow velocity: 2...3 m/s

For these specifications, the diagram indicates a pipe size of DN40 (or DN50 for (*) mentioned sensor-fittings)

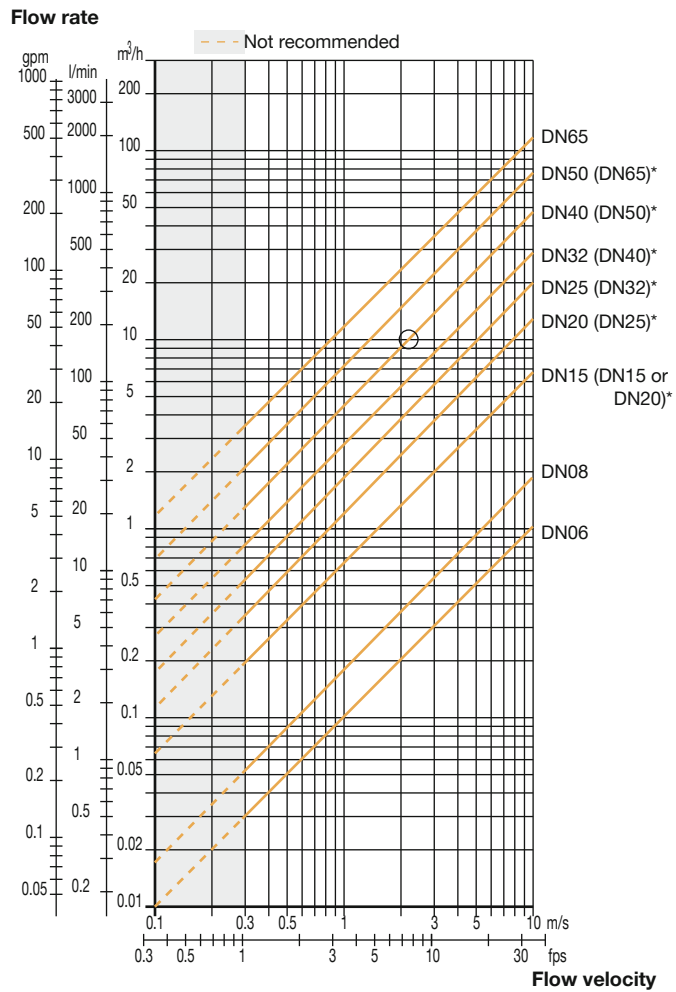

* for following sensor-fittings with:
 - external threads acc. to SMS 1145
 - weld ends acc. to SMS 3008, BS4825-1/ASME BPE/DIN 11866 series C or DIN 11850 series 2/DIN 11866 series A/DIN EN 10357 series A
 - Clamp acc. to SMS 3017, BS 4825-3/ASME BPE or DIN 32676 series A

Dimensions [mm] of flowmeter Type 8036

Transmitter SE36

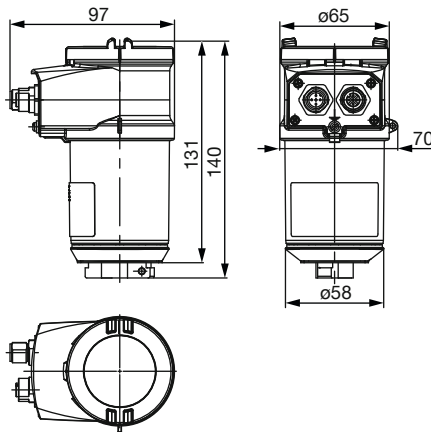

Flowmeter

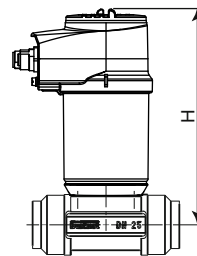

DN	H with S030 sensor-fitting
06	162
08	162
15	167
20	165
25	165
32	168
40	172
50	179
65	179

Ordering information for compact flowmeter Type 8036

A complete flowmeter Type 8036 consists of a compact flow ELEMENT transmitter Type SE36, a removable display/configuration module and a Bürkert INLINE sensor-fitting Type S030.

The following information is necessary for the selection of a complete device:

- Item no. of the desired compact flow transmitter **Type SE36** (see ordering chart on p. 6)
- Item no. of the selected INLINE sensor-fitting **Type S030** (see separate datasheet)

You always have to order the two components separately.









Attention!

When you order devices without the display/configuration module, please take care that you also order at least one display/configuration module for the operation.

Order no. of the removable display/configuration module (see ordering chart on p.6)

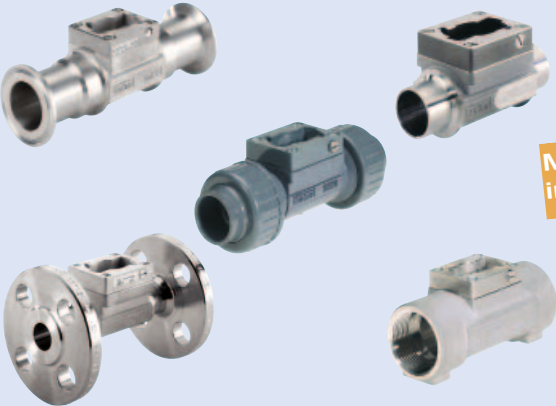

When you click on the orange box “More info.” below, you will come to our website for the resp. product where you can download the datasheet.

Example

<p>Compact transmitter with display/ configuration module Type SE36</p> 		<p>Complete flowmeter Type 8036</p>   
<p>Compact transmitter without display/ configuration module Type SE36</p> 	<p>Removable display/configu- ration module</p> 	
<p>INLINE sensor-fitting Type S030</p> 		







Ordering chart for compact flow transmitter Type SE36

Specification	Voltage supply	Output	Electrical connection	UL certification	Item no. without display/ configuration module	Item no. with display/ configuration module
2 outputs	14...36 V DC	1 x transistor NPN + 1 x 4...20 mA (2 wires)	5-pin M12 male fixed connector	No	560 880	561 880
				 Recognized	560 883	561 883
3 outputs	14...36 V DC	2 x transistors NPN/PNP + 1 x 4...20 mA (2 wires)	5-pin M12 male fixed connector	No	560 881	561 881
				 Recognized	560 884	561 884
4 outputs	12...36 V DC	2 x transistors NPN/PNP + 2 x 4...20 mA (2 wires)	5-pin M12 male and 5-pin M12 female fixed connectors	No	560 882	561 882
				 Recognized	560 885	561 885

Note: Order separately (see accessories)

- M12 cable plugs (only female for one 4...20 mA output, 1 male + 1 female for two 4...20 mA outputs flowmeter)

Ordering chart - accessories (has to be ordered separately)

Specification	Item no.
Removable display/configuration module (with instruction sheet)	559 168
Blind cover with seal (1 screw cover with EPDM seal + 1 quarter turn closing cover with silicone seal)	560 948
Transparent cover with seal (1 screw cover with EPDM seal + 1 quarter turn closing cover with silicone seal)	561 843
 5 pin M12 female straight cable plug with plastic threaded locking ring, to be wired	917 116
 5 pin M12 male straight cable plug with plastic threaded locking ring, to be wired	560 946
 5 pin M12 female straight cable plug moulded on cable (2 m, shielded)	438 680
 5 pin M12 male straight cable plug moulded on cable (2 m, shielded)	559 177

Interconnection possibilities with other Bürkert devices

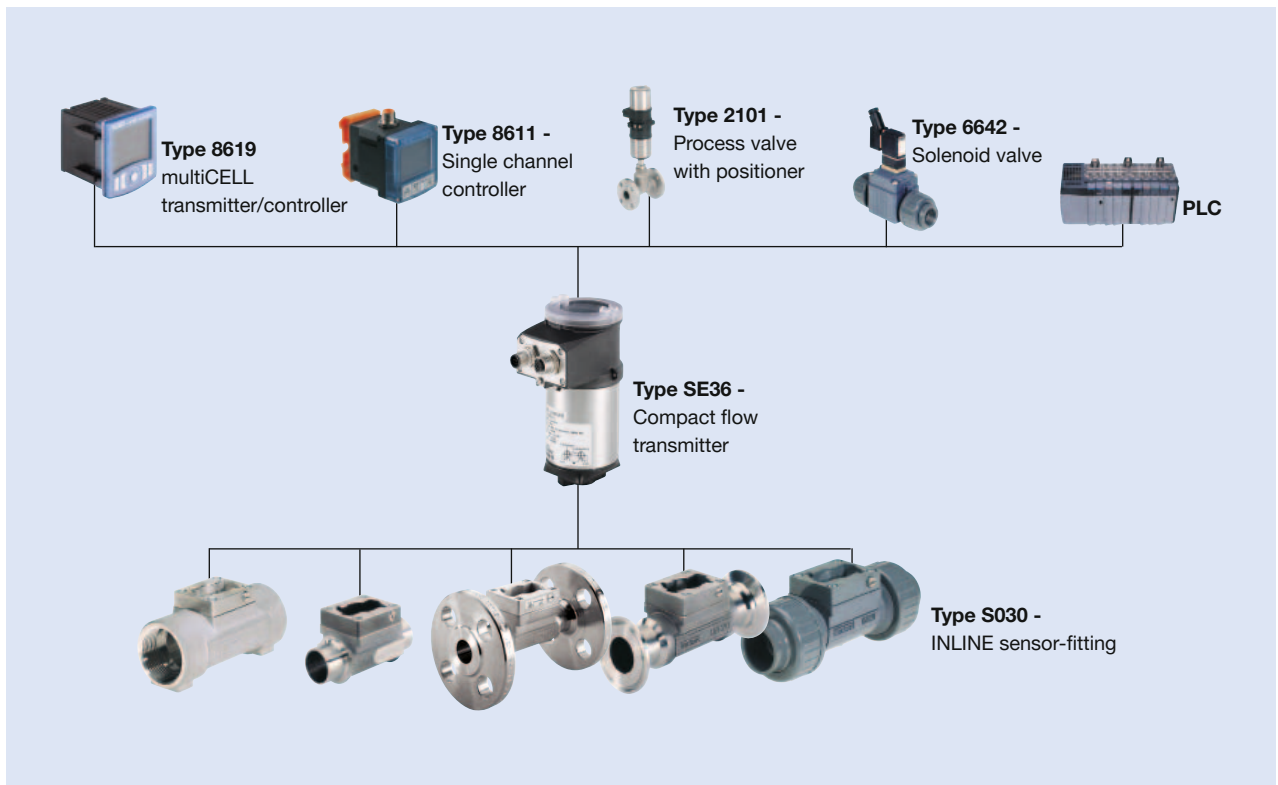

DTS 1000128709 EN Version: L Status: RL (released | freigegeben | validé) printed: 28.03.2017

To find your nearest Bürkert facility, click on the orange box →

www.burkert.com

In case of special application conditions,
please consult for advice.

Subject to alteration.
© Christian Bürkert GmbH & Co. KG

1703/11_EU-en_00895130