

Isys ISO Series

The Isys ISO valve conforms to international standards 15407 and 5599, providing maximum flexibility for end users. As Parker's premier manifold mount product offering, Isys ISO offers machine builders a complete offering with a wide variety of accessories and options in a valve family with flow ranges from 0.55 Cv up to 6.0 Cv. Individual wiring is available with DIN or central connectors, and collective solutions offer installation time savings with either multi-pin connectors or fieldbus solutions.

Ports, Flow

- HB: 1/8 inch, 0.55 Cv
- HA: 1/4 inch, 1.1 Cv
- H1: 3/8 inch, 1.5 Cv
- H2: 1/2 inch, 3.0 Cv
- H3: 3/4 inch, 6.0 Cv

Mounting

- Manifold or subbase

Solenoids

- HB & HA: 24 VDC, 1.0 Watt, and 120 VAC, 1.0 VA
- H1, H2, & H3: 24 VDC, 3.2 Watt, and 120 VAC, 4.5 VA

Certification / approval

- IP65 rated
- CSA / C-US approved

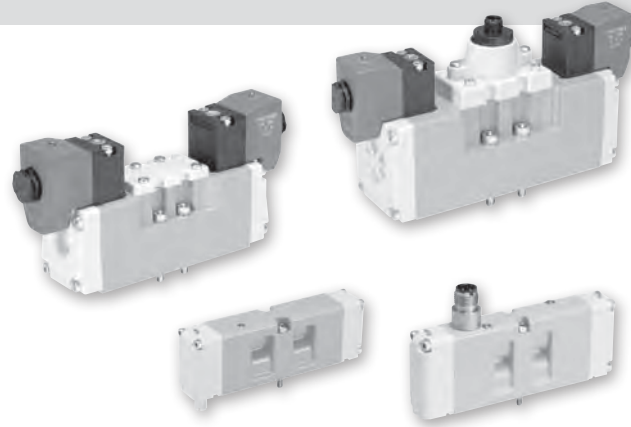

Operating information

Operating pressure:	Vacuum to 145 PSIG (Vacuum to 10 bar)
Pilot pressure:	See chart
Temperature range:	5°F to 120°F (-15°C to 49°C)

Material specifications

Body	Aluminum
End caps	PBT
End plates	Aluminum
Fasteners	Zinc plated steel
Manifolds	Aluminum
Seals	Nitrile
Spool	Aluminum

Operating Pressure

Maximum: 145 PSIG (1000 kPa)

Minimum:

Operator / function	Internal pilot	PSIG (Min. kPa) HB	PSIG (Min. kPa) HA	PSIG (Min. kPa) H1	PSIG (Min. kPa) H2	PSIG (Min. kPa) H3
1	Single solenoid - 2-position	30	25	25	25	35
2	Double solenoid- 2-position	(207)	(173)	(173)	(173)	(241)
3	Single remote pilot - 2-position **	Vacuum	Vacuum	Vacuum	Vacuum	Vacuum
4	Double remote pilot - 2-position**	Vacuum	Vacuum	Vacuum	Vacuum	Vacuum
5, 6, 7	Double solenoid - 3-position APB, CE, PC	35 (241)	35 (241)	35 (241)	50 (345)	50 (345)
8, 9, 0	Double remote pilot - 3-position** APB, CE, PC	Vacuum	Vacuum	Vacuum	Vacuum	Vacuum
E	Single solenoid pilot - 2-position					
	Air return / spring assist	30 (207)	30 (207)	35 (241)	45 (310)	45 (310)
F	Single remote pilot - 2-position**					
	Air return / spring assist					
N, P, Q	Double solenoid - dual 3/2	30 (207)	N/A	N/A	N/A	N/A
	External pilot *	*	*	*	*	*
All	Isys	Vacuum	Vacuum	Vacuum	Vacuum	Vacuum

* External Pilot Pressure / Remote Pilot Supply - Must meet or exceed minimum pilot pressure for internal pilot option. Not available on Operator / Function N, P, or Q.

** Must be equal to or greater than operating pressure.

Most popular.

Modulflex Series

Isys Micro Series

Isys ISO Series

Fieldbus Series

DX ISOMAX Series

Valvair II Series

D

Subbase & Manifold Valve Products

ISO Pneumatic Valve Standard Definitions

Modulflex Series
Isys Micro Series
Isys ISO Series
Fieldbus
DX ISOMAX Series
Valvair II Series
D
Subbase & Manifold Valve Products

15407-1: Non-Plug-in Standards for Size 01 (26mm) & Size 02 (18mm) Wide Valves

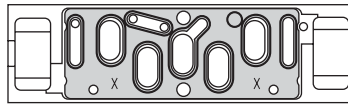

15407-2: Plug-in Standards for Size 01 (26mm) & Size 02 (18mm) Wide Valves

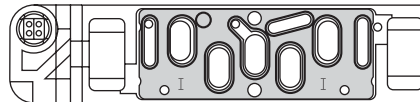

5599-1: Non-Plug-in Standards for Sizes 1, 2, 3

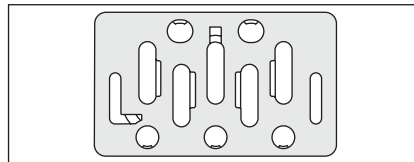

5599-2: Plug-in Standards for Size 1, 2, 3

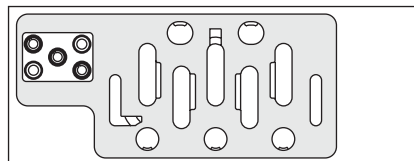





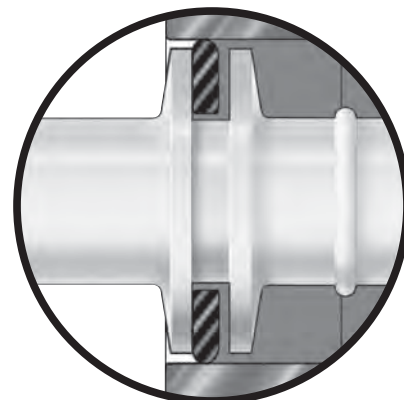











Wear Compensation System

- Maximum Performance
 - Low Friction
 - Fast Response
 - Lower Operating Pressures
 - Less Wear
- Long Cycle Life - Under pressure, radial expansion of the seal occurs to maintain sealing contact with the valve bore.
- Non-Lube Service - No lubrication required for continuous valve shifting.
- Bi-Directional Spool Seals - Common spool used for any pressure, including vacuum.





15407-2, Plug-in, Size 18mm (HB)

Symbol	Type	Cv	Operator	Voltage	Pilot	Non-locking	Locking
 Sol. 14	4-way, 2-position, spring return	0.55	Single solenoid	24 VDC	Internal	HBEVXBG0G9A	HBEVXBH0G9A
					External	HBEVXLG0G9A	HBEVXLH0G9A
 Sol. 14	4-way, 2-position, air return	0.55	Single solenoid	24 VDC	Internal	HB1VXBG0G9A	HB1VXBH0G9A
					External	HB1VXLG0G9A	HB1VXLH0G9A
 Sol. 14 Sol. 12	4-way, 2-position	0.55	Double solenoid	24 VDC	Internal	HB2VXBG0G9A	HB2VXBH0G9A
					External	HB2VXLG0G9A	HB2VXLH0G9A
 #14 #12	4-way, 3-position, all ports blocked	0.5	Double solenoid	24 VDC	Internal	HB5VXBG0G9A	HB5VXBH0G9A
					External	HB5VXLG0G9A	HB5VXLH0G9A
 #14 #12	4-way, 3-position, center exhaust	0.5	Double solenoid	24 VDC	Internal	HB6VXBG0G9A	HB6VXBH0G9A
					External	HB6VXLG0G9A	HB6VXLH0G9A
 #14 #12	4-way, 3-position, pressure center	0.5	Double solenoid	24 VDC	Internal	HB7VXBG0G9A	HB7VXBH0G9A
					External	HB7VXLG0G9A	HB7VXLH0G9A
 #14 #12	3-way, 2-position, dual valve, NC/NC	0.45	Double solenoid	24 VDC	Internal	HBNVXBG0G9A	HBNVXBH0G9A
					External	HBNVXLG0G9A	HBNVXLH0G9A
 #14 #12	3-way, 2-position, dual valve, NO/NO	0.45	Double solenoid	24 VDC	Internal	HBPVXBG0G9A	HBPVXBH0G9A
					External	HBPVXLG0G9A	HBPVXLH0G9A

Symbol	Type	Cv	Operator	Voltage	Pilot	Non-locking	Locking
 Sol. 14	4-way, 2-position, spring return	0.55	Single solenoid	120 VAC	Internal	HBEVXBG023A	HBEVXBH023A
					External	HBEVXLG023A	HBEVXLH023A
 Sol. 14	4-way, 2-position, air return	0.55	Single solenoid	120 VAC	Internal	HB1VXBG023A	HB1VXBH023A
					External	HB1VXLG023A	HB1VXLH023A
 Sol. 14 Sol. 12	4-way, 2-position	0.55	Double solenoid	120 VAC	Internal	HB2VXBG023A	HB2VXBH023A
					External	HB2VXLG023A	HB2VXLH023A
 #14 #12	4-way, 3-position, all ports blocked	0.5	Double solenoid	120 VAC	Internal	HB5VXBG023A	HB5VXBH023A
					External	HB5VXLG023A	HB5VXLH023A
 #14 #12	4-way, 3-position, center exhaust	0.5	Double solenoid	120 VAC	Internal	HB6VXBG023A	HB6VXBH023A
					External	HB6VXLG023A	HB6VXLH023A
 #14 #12	4-way, 3-position, pressure center	0.5	Double solenoid	120 VAC	Internal	HB7VXBG023A	HB7VXBH023A
					External	HB7VXLG023A	HB7VXLH023A
 #14 #12	3-way, 2-position, dual valve, NC/NC	0.45	Double solenoid	120 VAC	Internal	HBNVXBG023A	HBNVXBH023A
					External	HBNVXLG023A	HBNVXLH023A
 #14 #12	3-way, 2-position, dual valve, NO/NO	0.45	Double solenoid	120 VAC	Internal	HBPVXBG023A	HBPVXBH023A
					External	HBPVXLG023A	HBPVXLH023A

15407-2, Plug-in, Size 18mm (HB), 2-Station Manifold Bases

End ported bases	Enclosure / Lead length	Solenoid addresses	1/8" NPT	1/8" BSPP
	Circuit board	Single solenoid - 1 address	PS561151JP	PS561152JP
	Circuit board	Double solenoid - 2 addresses	PS561151MP	PS561152MP
	Circuit board with 32 output expansion	Single solenoid - 1 address	PS561151NP	PS561152NP
	Circuit board with 32 output expansion	Double solenoid - 2 addresses	PS561151PP	PS561152PP
Bottom / end ported bases				
	Circuit board	Single solenoid - 1 address	PS561161JP	PS561162JP
	Circuit board	Double solenoid - 2 addresses	PS561161MP	PS561162MP
	Circuit board with 32 output expansion	Single solenoid - 1 address	PS561161NP	PS561162NP
	Circuit board with 32 output expansion	Double solenoid - 2 addresses	PS561161PP	PS561162PP



Modulflex Series

Isys Micro Series

Isys ISO Series

Fieldbus Series







DX ISOMAX Series

Valvair II Series

D





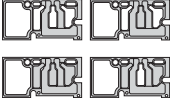

Subbase & Manifold Valve Products

15407-2, Plug-in, Size 18mm (HB) Accessories

	Accessories	Description	Part number
Modulflex Series		Common pressure	2-60 PSIG w/ gauge PS5638155P
		Common pressure	5-125 PSIG w/ gauge PS5638166P
		Independent pressure	2-60 PSIG w/ gauge PS5638255P
		Independent pressure	5-125 PSIG w/ gauge PS5638266P
		Gauge adapter kit	Includes 1/8" coupling and long nipple PS5651160P
Isys Micro Series		Blanking plate kit	PS5634P
		Sandwich supply module	1/8" NPT PS561600P
1/8" BSPP PS561601P			
Isys ISO Series		Sandwich exhaust module	1/8" NPT PS561700P
		1/8" BSPP PS561701P	
		Intermediate air supply module	1/8" NPT D02P-01-80
Fieldbus		Sandwich flow control	PS5635P
		Standard	PS561AP
Blocked #1 port		PS561BP	
Blocked #1, 3, 5, ports		PS561CP	
Blocked #3, 5 ports		PS561DP	







Modulflex Series
 Isys Micro Series
 Isys ISO Series
 Fieldbus
 DX ISOMAX Series
 Valvair II Series
D
 Subbase & Manifold Valve Products

15407-2, Plug-in, Size 26mm (HA)

Symbol	Type	Cv	Operator	Voltage	Pilot	Non-locking	Locking
 Sol. 14	4-way, 2-position, spring return	1.1	Single solenoid	24 VDC	Internal	HAEVXBG0G9A	HAEVXBH0G9A
					External	HAEVXLG0G9A	HAEVXLH0G9A
 Sol. 14	4-way, 2-position, air return	1.1	Single solenoid	24 VDC	Internal	HA1VXBG0G9A	HA1VXBH0G9A
					External	HA1VXLG0G9A	HA1VXLH0G9A
 Sol. 14 Sol. 12	4-way, 2-position	1.1	Double solenoid	24 VDC	Internal	HA2VXBG0G9A	HA2VXBH0G9A
					External	HA2VXLG0G9A	HA2VXLH0G9A
 #14 #12	4-way, 3-position, all ports blocked	1.0	Double solenoid	24 VDC	Internal	HA5VXBG0G9A	HA5VXBH0G9A
					External	HA5VXLG0G9A	HA5VXLH0G9A
 #14 #12	4-way, 3-position, center exhaust	1.0	Double solenoid	24 VDC	Internal	HA6VXBG0G9A	HA6VXBH0G9A
					External	HA6VXLG0G9A	HA6VXLH0G9A
 #14 #12	4-way, 3-position, pressure center	1.0	Double solenoid	24 VDC	Internal	HA7VXBG0G9A	HA7VXBH0G9A
					External	HA7VXLG0G9A	HA7VXLH0G9A

Modulflex Series

Isys Micro Series

Symbol	Type	Cv	Operator	Voltage	Pilot	Non-locking	Locking
 Sol. 14	4-way, 2-position, spring return	1.1	Single solenoid	120 VAC	Internal	HAEVXBG023A	HAEVXBH023A
					External	HAEVXLG023A	HAEVXLH023A
 Sol. 14	4-way, 2-position, air return	1.1	Single solenoid	120 VAC	Internal	HA1VXBG023A	HA1VXBH023A
					External	HA1VXLG023A	HA1VXLH023A
 Sol. 14 Sol. 12	4-way, 2-position	1.1	Double solenoid	120 VAC	Internal	HA2VXBG023A	HA2VXBH023A
					External	HA2VXLG023A	HA2VXLH023A
 #14 #12	4-way, 3-position, all ports blocked	1.0	Double solenoid	120 VAC	Internal	HA5VXBG023A	HA5VXBH023A
					External	HA5VXLG023A	HA5VXLH023A
 #14 #12	4-way, 3-position, center exhaust	1.0	Double solenoid	120 VAC	Internal	HA6VXBG023A	HA6VXBH023A
					External	HA6VXLG023A	HA6VXLH023A
 #14 #12	4-way, 3-position, pressure center	1.0	Double solenoid	120 VAC	Internal	HA7VXBG023A	HA7VXBH023A
					External	HA7VXLG023A	HA7VXLH023A

Isys ISO Series

Fieldbus Series

DX ISOMAX Series



15407-2, Plug-in, Size 26mm (HA), Single Subbase

Enclosure / Lead length	Solenoid addresses	1/4" NPT	1/4" BSPP
 Terminal strip in the base	Double solenoid - 2 addresses	PS55113CP	PS55114CP

Valvair II Series







D

15407-2, Plug-in, Size 26mm (HA), 2-Station Manifold Bases

End ported bases	Enclosure / Lead length	Solenoid addresses	1/4" NPT	1/4" BSPP
	Circuit board	Single solenoid - 1 address	PS551153JP	PS551154JP
	Circuit board	Double solenoid - 2 addresses	PS551153MP	PS551154MP
	Circuit board with 32 output expansion	Single solenoid - 1 address	PS551153NP	PS551154NP
	Circuit board with 32 output expansion	Double solenoid - 2 addresses	PS551153PP	PS551154PP
	Terminal strip in the base	Double solenoid - 2 addresses	PS551153CP	PS551154CP
Bottom / end ported bases				
	Circuit board	Single solenoid - 1 address	PS551163JP	PS551164JP
	Circuit board	Double solenoid - 2 addresses	PS551163MP	PS551164MP
	Circuit board with 32 output expansion	Single solenoid - 1 address	PS551163NP	PS551164NP
	Circuit board with 32 output expansion	Double solenoid - 2 addresses	PS551163PP	PS551164PP
	Terminal strip in the base	Double solenoid - 2 addresses	PS551163CP	PS551164CP

Subbase & Manifold Valve Products

15407-2, Plug-in, Size 26mm (HA) Accessories

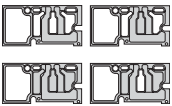
	Accessories	Description	Part number
Modulflex Series		Common pressure	2-60 PSIG w/ gauge PS5538155P
		Common pressure	5-125 PSIG w/ gauge PS5538166P
		Independent pressure	2-60 PSIG w/ gauge PS5538255P
		Independent pressure	5-125 PSIG w/ gauge PS5538266P
		Gauge adapter kit	Includes 1/8" coupling and long nipple PS5651160P
Isys Micro Series		Blanking plate kit PS5534P	
		Sandwich supply module	1/4" NPT PS551600P
			1/4" BSPP PS551601P
Isys ISO Series		Sandwich exhaust module	1/4" NPT PS551700P
			1/4" BSPP PS551701P
		Intermediate air supply module	1/4" NPT D01P-02-80
Fieldbus		Sandwich flow control PS5535P	
DX ISOMAX Series		Standard	PS561AP
		Blocked #1 port	PS561BP
		Blocked #1, 3, 5, ports	PS561CP
		Blocked #3, 5 ports	PS561DP

Modulflex Series

Isys Micro Series

Isys ISO Series

Fieldbus









DX ISOMAX Series

Valvair II Series

D

Subbase & Manifold Valve Products

15407-2, Plug-in, Size 18mm & 26mm End Plate Kits

	Electrical option	NPT port	BSP port
	No connector - use with terminal strip in base	PS5631010P	PS5631011P
	25-pin, D-Sub	PS5620L20P	PS5620L21P
	19-pin, round, Brad Harrison	PS5620L30P	PS5620L31P
	12-pin, M23	PS5620L40P	PS5620L41P
	16-point terminal strip	PS5620L50P	PS5620L51P
	19-pin, M23	PS5620M20P	PS5620M21P
	Moduflex fieldbus	PS5620M40P	PS5620M41P
	Isysnet, with valve driver module	PS5620L60P	PS5620L61P
	Turck fieldbus with valve driver module - 16 outputs	PS5620T10P	PS5620T11P
	Turck fieldbus with valve driver module - 32 outputs	PS5620T20P	PS5620T21P

15407-2 End Plate Kits with Transition to H2

	Electrical option	NPT port	BSP port
	25-pin, D-sub	PS5624L20P	PS5624L21P
	19-pin, round, Brad Harrison	PS5624L30P	PS5624L31P
	12-pin, M23	PS5624L40P	PS5624L41P
	16-point terminal strip	PS5624L50P	PS5624L51P
	19-pin, M23	PS5624M20P	PS5624M21P
	Moduflex fieldbus	PS5624M40P	PS5624M41P
	Isysnet, with valve driver module	PS5624L60P	PS5624L61P
	Turck fieldbus with valve driver module - 16 outputs	PS5624T10P	PS5624T11P
	Turck fieldbus with valve driver module - 32 outputs	PS5624T20P	PS5624T21P

Turck, Isysnet, and Moduflex communication modules must be ordered separately. See Fieldbus Section for more information.

Note:

For cable part numbers and pin out information see Fieldbus System Accessories.

Moduflex Series
Isys Micro Series
Isys ISO Series
Fieldbus
DX ISOMAX Series
Valvair II Series
D
Subbase & Manifold Valve Products

How To Order Plug-in Add-A-Fold Assemblies

1. List Add-A-Fold Assembly call out. This automatically includes the end plate kit assembly.
2. List complete Valve, Regulator, Flow Control and Base model number. List left to right, LOOKING AT THE CYLINDER PORTS on the #12 end of the manifold. The left most station is station 1. (If a blank station is needed, list the blanking plate part number and the individual manifold number in the station specified.)

Example

Application requires a 4-Station manifold.
 (Two 18mm + Two 26mm Stations)

Item	Qty.	Part No.	Location
01	1	AAHBD004	
02	1	HB1VXBGOG9A	Station 1
03	1	HB2VXLGOG9A	Station 2
04	1	PS561151MP	Station 1 & 2
05	2	HA1VXBGOG9A	Station 3 & 4
06	1	PS551151MP	Station 3 & 4

NOTE: Construct manifold assemblies from left to right while looking at the ports. Valves must be ordered as External Pilot when using Sandwich Regulator.

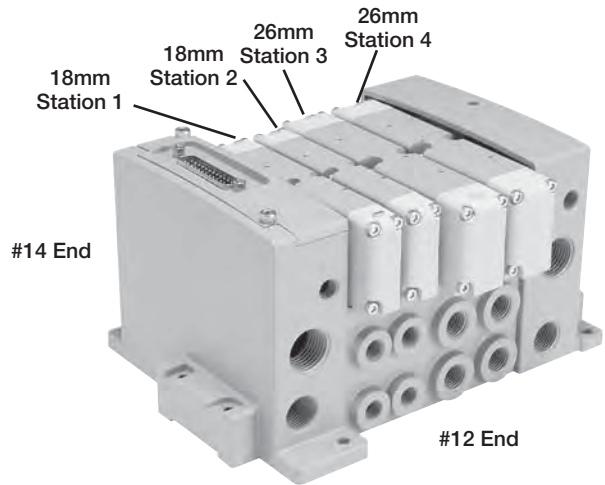

Example:
 4-Station Manifold with (2) 18mm and (2) 26mm Valves on Manifold Bases with 25-pin, D-Sub End Plates

**Maximum Number of Solenoids
 (Maximum energized simultaneously)**

Voltage	Voltage code	25-pin D-sub	19-pin M23 or		Modulflex Isysnet	Turck		
			Brad Harrison	12-pin M23		16	32	
24VDC	G9	24 (24)	16 (16)	8 (8)	16 (16)	32 (32)	16 (16)	32 (32)
120VAC*	23	24 (24)	16 (16)	8 (8)	N/A	N/A	N/A	N/A

* Not CSA certified for 25-pin, D-Sub option.

When using an HA or HB manifold base with the "N" Enclosure / Lead Length option:

- Outputs 1 – 24 can be single or double address bases. Use a base with "J" or "M" Enclosure / Lead Length option.
- Outputs 25 – 26 are a single address base. Use a base with "N" Enclosure / Lead Length option (this is a single address board with a ribbon connection from the valve driver module, PSSV32A).
- Outputs 27 – 32 can be single or double. Use a base with "J" or "M" Enclosure / Lead Length option.

When using an HA or HB manifold base with the "P" Enclosure / Lead Length option:

- Outputs 1 – 24 can be single or double address bases. Use a base with "J" or "M" Enclosure / Lead Length option.
- Outputs 25 – 28 are a double address base. Use a base with "P" Enclosure / Lead Length option (this is a double address board with a ribbon connection from the valve driver module, PSSV32A).
- Outputs 29 – 32 can be single or double. Use a base with "J" or "M" Enclosure / Lead Length option.

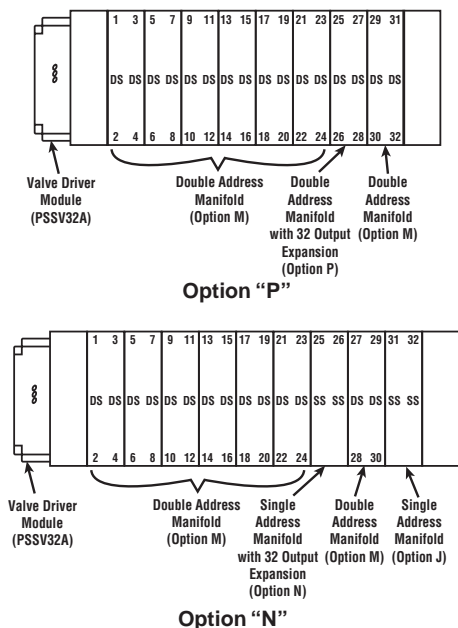

Add-A-Fold Assembly Model Number

AA	HB	D	0	04
Valve series		End plate type		Number of stations*
Right & left end plate 15407-2 (plug-in, HB 18mm & HA 26mm)		Turck fieldbus with valve driver module - 16 outputs Turck fieldbus with valve driver module - 32 outputs 25-pin, D-sub 19-pin, Brad Harrison 16 Point terminal strip 12-pin, M23 19-pin, M23 Modulflex fieldbus Isysnet, with valve driver module		02 04 • 24 • 32
* Common end plates for HA & HB.				Thread type
				0 NPT 1* BSPP "G"
				* Must be ordered in multiples of (2) unless using the HB / HA to H2 Transition Plate.
				* BSPP conforms to ISO 1179-1 with 228-1 threads.
				*Must order communication modules separately.

15407-2, Plug-in, Size 18mm (HB) & 26mm (HA)

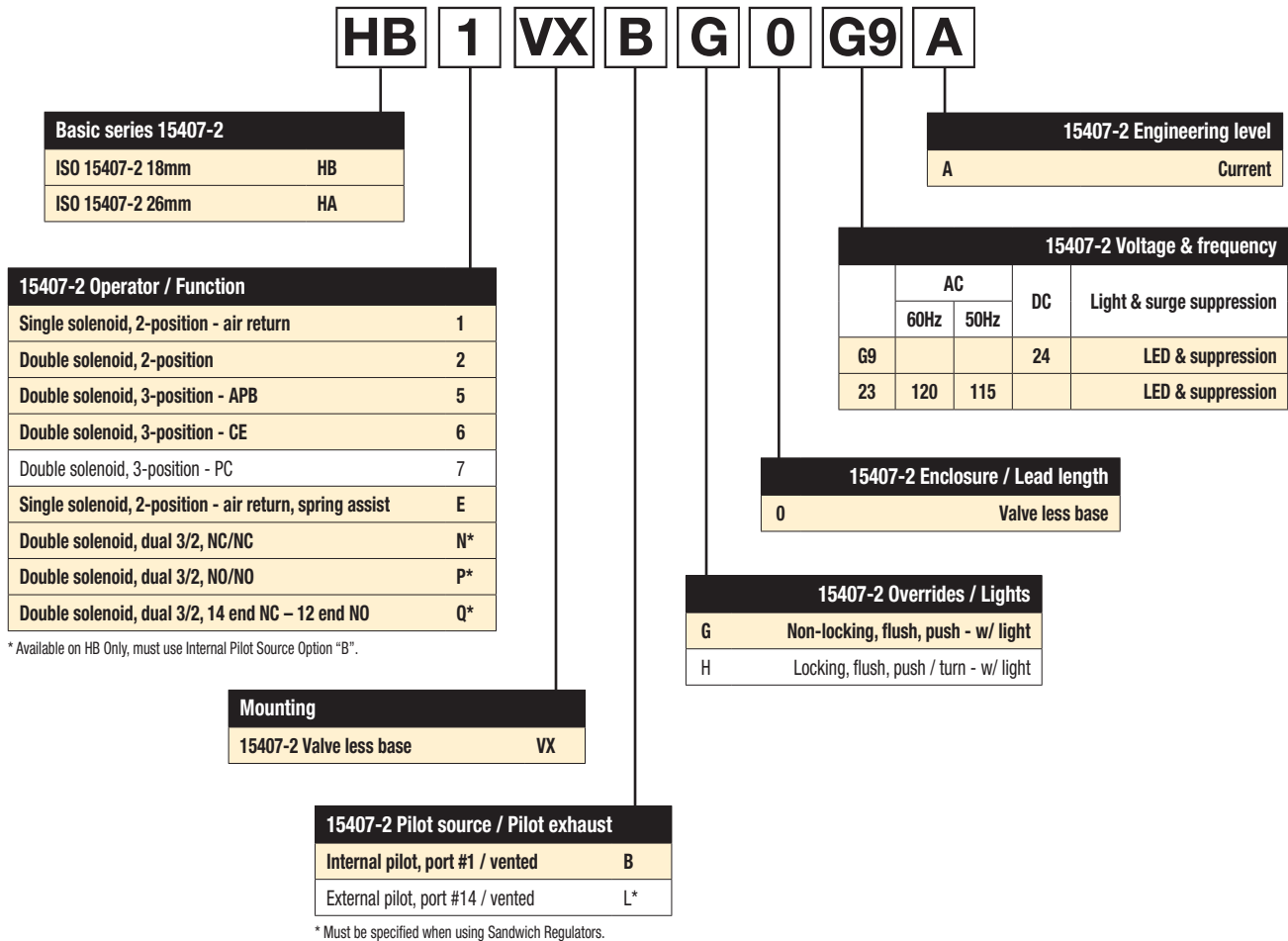

* Must be specified when using Sandwich Regulators.

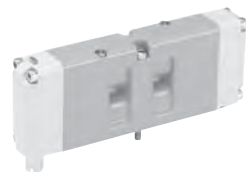

HB: 18mm

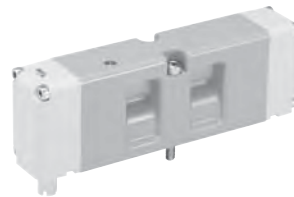









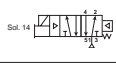
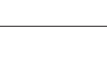

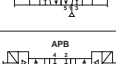

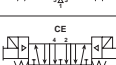
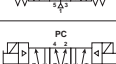

HA: 26mm

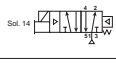
 Most popular.

Modulflex Series
Isys Micro Series
Isys ISO Series
Fieldbus
DX ISOMAX Series
Valvair II Series
D
Subbase & Manifold Valve Products

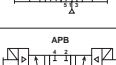
5599-2, Plug-in, Size 1 (H1)

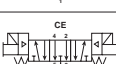
Symbol	Type	Cv	Operator	Voltage	Pilot	Non-locking	Locking	
 Sol. 14		4-way, 2-position, spring return	1.5	Single solenoid	24 VDC	Internal	H1EVXBG0B9D	H1EVXBH0B9D
						External	H1EVXXG0B9D	H1EVXXH0B9D
 Sol. 14		4-way, 2-position, air return	1.5	Single solenoid	24 VDC	Internal	H11VXBG0B9D	H11VXBH0B9D
						External	H11VXXG0B9D	H11VXXH0B9D
 Sol. 14		4-way, 2-position	1.5	Double solenoid	24 VDC	Internal	H12VXBG0B9D	H12VXBH0B9D
						External	H12VXXG0B9D	H12VXXH0B9D
 #14		4-way, 3-position, all ports blocked	1.2	Double solenoid	24 VDC	Internal	H15VXBG0B9D	H15VXBH0B9D
						External	H15VXXG0B9D	H15VXXH0B9D
							4-way, 3-position, center exhaust	1.2
External	H16VXXG0B9D	H16VXXH0B9D						
	4-way, 3-position, pressure center	1.2	Double solenoid	24 VDC	Internal	H17VXBG0B9D	H17VXBH0B9D	
					External	H17VXXG0B9D	H17VXXH0B9D	

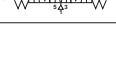
Symbol	Type	Cv	Operator	Voltage	Pilot	Non-locking	Locking	
 Sol. 14		4-way, 2-position, spring return	1.5	Single solenoid	120 VAC	Internal	H1EVXBG023D	H1EVXBH023D
						External	H1EVXXG023D	H1EVXXH023D
 Sol. 14		4-way, 2-position, air return	1.5	Single solenoid	120 VAC	Internal	H11VXBG023D	H11VXBH023D
						External	H11VXXG023D	H11VXXH023D
 Sol. 14		4-way, 2-position	1.5	Double solenoid	120 VAC	Internal	H12VXBG023D	H12VXBH023D
						External	H12VXXG023D	H12VXXH023D
 #14		4-way, 3-position, all ports blocked	1.2	Double solenoid	120 VAC	Internal	H15VXBG023D	H15VXBH023D
						External	H15VXXG023D	H15VXXH023D
							4-way, 3-position, center exhaust	1.2
External	H16VXXG023D	H16VXXH023D						
	4-way, 3-position, pressure center	1.2	Double solenoid	120 VAC	Internal	H17VXBG023D	H17VXBH023D	
					External	H17VXXG023D	H17VXXH023D	

5599-2, Plug-in Single Subbase, Size 1 (H1)

Side ported	Enclosure / Lead length	Solenoid addresses	3/8" NPT	3/8" BSPP
	Terminal strip in base	Double solenoid - 2 address	PS401115CDP	PS401116CDP
	6" flying leads	Double solenoid - 2 addresses	PS401115ADP	PS401116ADP
	4-pin, M12 micro connector in base, SAE / Ford wiring	Double solenoid - 2 addresses	PS4011158FDP	PS4011168FDP





5599-2, Plug-in Manifold Bases, Size 1 (H1)

Bottom / End	Enclosure / Lead length	Solenoid addresses	3/8" NPT	3/8" BSPP
	Circuit board	Single solenoid - 1 address	PS401165JCP	PS401166JCP
	Circuit board	Double solenoid - 2 addresses	PS401165MCP	PS401166MCP
	Terminal strip in base	Double solenoid - 2 address	PS401165CCP	PS401166CCP
	6" flying leads	Double solenoid - 2 addresses	PS401165ACP	PS401166ACP
	4-pin, M12 micro connector in base, SAE / Ford wiring	Double solenoid - 2 addresses	PS4011658FCP	PS4011668FCP





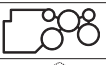
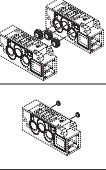

End Ported	Enclosure / Lead length	Solenoid addresses	3/8" NPT	3/8" BSPP
	Circuit board	Single solenoid - 1 address	PS401155JCP	PS401156JCP
	Circuit board	Double solenoid - 2 addresses	PS401155MCP	PS401156MCP
	Terminal strip in base	Double solenoid - 2 address	PS401155CCP	PS401156CCP
	6" flying leads	Double solenoid - 2 addresses	PS401155ACP	PS401156ACP

Modulflex Series
 Isys Micro Series
 Isys ISO Series
 Fieldbus Series
 DX ISOMAX Series
 Valvair II Series
 Subbase & Manifold Valve Products

5599-2, Size 1 (H1) Accessories

Accessory	Description	Part number
	Common pressure	5-125 PSIG w/ gauge PS4038166CP
	Independent pressure	5-125 PSIG w/ gauge PS4038266CP
	Blanking plate kit	PS4034CP
	Sandwich flow control	PS4035CP
	Manifold to manifold gasket kits	PS4013P
	Main galley (1, 3, 5)	PS4032CP
	Pilot galley	PS4033CP
	1/4" & 3/8"	NPT PS403000CP
		BSPP PS403001CP

Plug-in, 5599-2 End Plate Kits, Size 1 (H1)

Electrical option	Description	NPT port	BSPP port
	No connector - use with individually wired base	PS4031010DP	PS4031011DP
	25-pin, D-sub	PS4020L20DP	PS4020L21DP
	19-pin, round, Brad Harrison	PS4020L30DP	PS4020L31DP
	12-pin, M23	PS4020L40DP	PS4020L41DP
	19-pin, M23	PS4020M20DP	PS4020M21DP
	Moduflex fieldbus	PS4020M40DP	PS4020M41DP
	Isysnet, with valve driver module	PS4020L60DP	PS4020L61DP
	Turck fieldbus with valve driver module - 16 outputs	PS4020T10DP	PS4020T11DP
	Turck fieldbus with valve driver module - 24 outputs	PS4020T20DP	PS4020T21DP

Turck, Isysnet, and Moduflex communication modules must be ordered separately. See Fieldbus Section for more information.

Note:

For cable part numbers and pin out information see Fieldbus System Accessories.

Moduflex Series

Isys Micro Series

Isys ISO Series

Fieldbus

DX ISOMAX Series

Valvair II Series

D

Subbase & Manifold Valve Products

How To Order Plug-in Add-A-Fold Assemblies

1. List Add-A-Fold Assembly call out. This automatically includes the end plate kit assembly.
2. List complete Valve, Regulator, Flow Control and Base model number. List left to right, LOOKING AT THE CYLINDER PORTS on the #12 end of the manifold. The left most station is station 1. (If a blank station is needed, list the blanking plate part number and the individual manifold number in the station specified.)

Example

Application requires a 3-Station manifold with a valve, regulator on Station 3.

Item	Qty.	Part No.	Location
01	1	AAH1D003	
02	1	H11VXBG0B9D	Station 1
03	1	PS401155MCP	Station 1
04	1	H12VXBG0B9D	Station 2
05	1	PS401155MCP	Station 2
06	1	H12VXXG0B9D	Station 3
07	1	PS4038166CP	Station 3
08	1	PS401155MCP	Station 3

NOTE:

Construct manifold assemblies from left to right while looking at the cylinder ports. Valves must be ordered as External Pilot when using Sandwich Regulator.

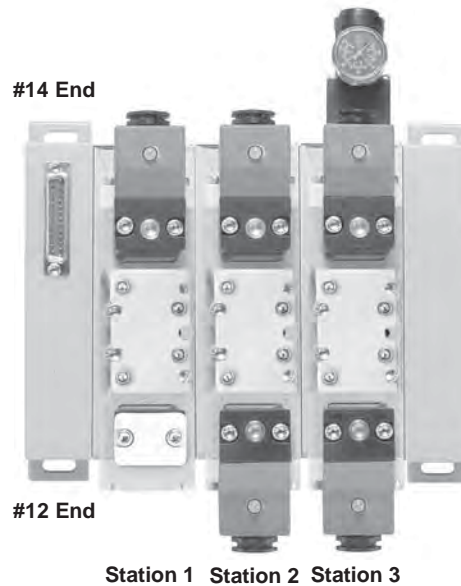

**Example:
 3-Station Manifold with (3) H1 Valves
 on Manifold Bases
 and Regulator at Station 3**

**Maximum Number of Solenoids
 (Maximum energized simultaneously)**

Voltage	Voltage code	25-pin D-sub	19-pin M23 or Brad Harrison		12-pin M23	Modulflex	Isysnet	Turck	
			16	32				16	32
24VDC	G9	24 (24)	16 (16)	8 (8)	16 (16)	24 (21)	16 (16)	24 (21)	
120VAC*	23	24 (24)	16 (16)	8 (8)	N/A	N/A	N/A	N/A	

* Not CSA certified for 25-pin, D-Sub option.

Add-A-Fold Assembly Model Numbers





AA	H1	D	0	03
Valve series Right & left end plate H1				Number of stations 01 02 03 04 • • 24
End plate type Turck fieldbus with valve driver module - 16 outputs A* Turck fieldbus with valve driver module - 32 outputs B* 25-pin, D-sub D 19-pin, brad harrison E 12-pin, M23 G 19-pin, M23 H Standard, non-collective wiring S Modulflex fieldbus T* Isysnet, with valve driver module X*				Thread type 0 NPT 1* BSPP "G"



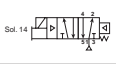

* Must order communication modules separately.

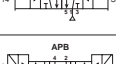
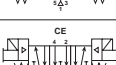
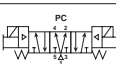
* BSPP conforms to ISO 1179-1 w 228-1 threads.

Modulflex Series
Isys Micro Series
Isys ISO Series
Fieldbus
DX ISOMAX Series
Valvair II Series
D
Subbase & Manifold Valve Products

5599-2, Plug-in, Size 2 (H2)

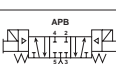
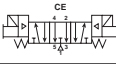
Symbol	Type	Cv	Operator	Voltage	Pilot	Non-locking	Locking					
 Sol. 14	4-way, 2-position, spring return	3.0	Single solenoid	24 VDC	Internal	H2EVXBG0B9D	H2EVXBH0B9D					
					External	H2EVXXG0B9D	H2EVXXH0B9D					
 Sol. 14	4-way, 2-position, air return	3.0	Single solenoid	24 VDC	Internal	H21VXBG0B9D	H21VXBH0B9D					
					External	H21VXXG0B9D	H21VXXH0B9D					
 Sol. 14 Sol. 12	4-way, 2-position	3.0	Double solenoid	24 VDC	Internal	H22VXBG0B9D	H22VXBH0B9D					
					External	H22VXXG0B9D	H22VXXH0B9D					
					 #14 APB #12	4-way, 3-position, all ports blocked	2.8	Double solenoid	24 VDC	Internal	H25VXBG0B9D	H25VXBH0B9D
										External	H25VXXG0B9D	H25VXXH0B9D
 #14 CE #12	4-way, 3-position, center exhaust	2.8	Double solenoid	24 VDC	Internal	H26VXBG0B9D	H26VXBH0B9D					
					External	H26VXXG0B9D	H26VXXH0B9D					
 #14 PC #12	4-way, 3-position, pressure center	2.8	Double solenoid	24 VDC	Internal	H27VXBG0B9D	H27VXBH0B9D					
					External	H27VXXG0B9D	H27VXXH0B9D					

Symbol	Type	Cv	Operator	Voltage	Pilot	Non-locking	Locking					
 Sol. 14	4-way, 2-position, spring return	3.0	Single solenoid	120 VAC	Internal	H2EVXBG023D	H2EVXBH023D					
					External	H2EVXXG023D	H2EVXXH023D					
 Sol. 14	4-way, 2-position, air return	3.0	Single solenoid	120 VAC	Internal	H21VXBG023D	H21VXBH023D					
					External	H21VXXG023D	H21VXXH023D					
 Sol. 14 Sol. 12	4-way, 2-position	3.0	Double solenoid	120 VAC	Internal	H22VXBG023D	H22VXBH023D					
					External	H22VXXG023D	H22VXXH023D					
					 #14 APB #12	4-way, 3-position, all ports blocked	2.8	Double solenoid	120 VAC	Internal	H25VXBG023D	H25VXBH023D
										External	H25VXXG023D	H25VXXH023D
 #14 CE #12	4-way, 3-position, center exhaust	2.8	Double solenoid	120 VAC	Internal	H26VXBG023D	H26VXBH023D					
					External	H26VXXG023D	H26VXXH023D					
 #14 PC #12	4-way, 3-position, pressure center	2.8	Double solenoid	120 VAC	Internal	H27VXBG023D	H27VXBH023D					
					External	H27VXXG023D	H27VXXH023D					





5599-2, Plug-in Single Subbase, Size 2 (H2)

Side ported base	Enclosure / Lead length	Solenoid addresses	1/2" NPT	1/2" BSPP
	Terminal strip in base	Double solenoid - 2 address	PS411117CCP	PS411118CCP
	6" flying leads	Double solenoid - 2 addresses	PS411117ACP	PS411118ACP





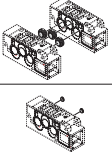

5599-2, Plug-in Manifold Bases, Size 2 (H2)

Bottom / End ported bases	Enclosure / Lead length	Solenoid addresses	1/2" NPT	1/2" BSPP
	Circuit board	Single solenoid - 1 address	PS411167JCP	PS411168JCP
	Circuit board	Double solenoid - 2 addresses	PS411167MCP	PS411168MCP
	Terminal strip in base	Double solenoid - 2 address	PS411167CCP	PS411168CCP
	6" flying leads	Double solenoid - 2 addresses	PS411167ACP	PS411168ACP
End Ported	Enclosure / Lead length	Solenoid addresses	1/2" NPT	1/2" BSPP
	Circuit board	Single solenoid - 1 address	PS411157JCP	PS411158JCP
	Circuit board	Double solenoid - 2 addresses	PS411157MCP	PS411158MCP
	Terminal strip in base	Double solenoid - 2 address	PS411157CCP	PS411158CCP
	6" flying leads	Double solenoid - 2 addresses	PS411157ACP	PS411158ACP

5599-2, Size 2 (H2) Accessories

	Accessory	Description	Part number
Modulflex Series		Common pressure 5-125 PSIG w/ gauge	PS4138166CP
		Independent pressure 5-125 PSIG w/ gauge	PS4138266CP
Isys Micro Series		Blanking plate kit	PS4134CP
		Sandwich flow control	PS4135CP
		Manifold to manifold gasket kits	PS4113P
Isys ISO Series		Main galley (1, 3, 5)	PS4132CP
		Pilot galley	PS4033CP

Plug-in, 5599-2 End Plate Kits, Size 2 (H2)

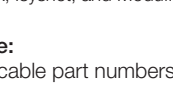
	Electrical option	Description	NPT port	BSPP port
DX ISOMAX Series		No connector - use with individually wired base	PS4131010DP	PS4131011DP
			25-pin, D-sub	PS4120L20DP
Valvair II Series		19-pin, round, Brad Harrison	PS4120L30DP	PS4120L31DP
			12-pin, M23	PS4120L40DP
Subbase & Manifold Valve Products			19-pin, M23	PS4120M20DP
			Modulflex fieldbus	PS4120M40DP
		Isysnet, with valve driver module	PS4120L60DP	PS4120L61DP
			Turck fieldbus with valve driver module - 16 outputs	PS4120T10DP
	Turck fieldbus with valve driver module - 24 outputs		PS4120T20DP	PS4120T21DP

Turck, Isysnet, and Modulflex communication modules must be ordered separately. See Fieldbus Section for more information.

Note:

For cable part numbers and pin out information see Fieldbus System Accessories.

How To Order Plug-in Add-A-Fold Assemblies

1. List Add-A-Fold Assembly call out. This automatically includes the end plate kit assembly.
2. List complete Valve, Regulator, Flow Control and Base model number. List left to right, LOOKING AT THE CYLINDER PORTS on the #12 end of the manifold. The left most station is station 1. (If a blank station is needed, list the blanking plate part number and the individual manifold number in the station specified.)

Example

Application requires a 3-Station manifold with a valve and regulator on Station 3.

Item	Qty.	Part No.	Location
01	1	AAH2D003	
02	1	H21VXBG0B9D.....	Station 1
03	1	PS411157MCP.....	Station 1
04	1	H22VXBG0B9D.....	Station 2
05	1	PS411157MCP.....	Station 2
06	1	H22VXXG0B9D.....	Station 3
07	1	PS4138166CP.....	Station 3
08	1	PS411157MCP.....	Station 3

NOTE: Construct manifold assemblies from left to right while looking at the cylinder ports.
 Valves must be ordered as External Pilot when using Sandwich Regulator.

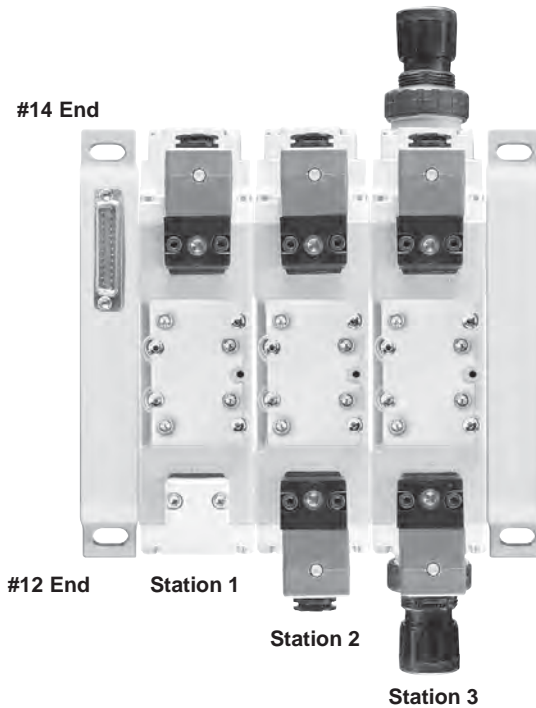

**Example:
 3-Station Manifold with (3) H2 Valves
 on Manifold Bases and Regulator at Station 3**

**Maximum Number of Solenoids
 (Maximum energized simultaneously)**

Voltage	Voltage code	25-pin D-sub	19-pin M23 or Brad Harrison		12-pin M23	Turck		
			Moduflex	Isysnet		16 Outputs	32 Outputs	
24VDC	G9	24 (24)	16 (16)	8 (8)	16 (16)	24 (21)	16 (16)	24 (21)
120VAC*	23	24 (24)	16 (16)	8 (8)	N/A	N/A	N/A	N/A

* Not CSA certified for 25-pin, D-Sub option.

Add-A-Fold Assembly Model Numbers

AA H2 D 0 03

Valve series	
Right & left end plate	H2
End plate type	
Turck fieldbus with valve driver module - 16 outputs	A*
Turck fieldbus with valve driver module - 32 outputs	B*
25-pin, D-sub	D†
19-pin, brad harrison	E†
12-pin, M23	G†
19-pin, M23	H†
Standard, non-collective wiring	S
Moduflex fieldbus	T*
Isysnet, with valve driver module	Y*







Number of stations	
01	
02	
03	
04	
•	
•	
24	

Thread type	
0	NPT
1*	BSPPP "G"

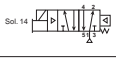
* BSPP conforms to ISO 1179-1 w 228-1 threads.

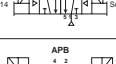
* Must order communication modules separately.
 † Collective wiring module included.

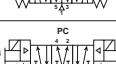
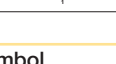
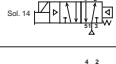
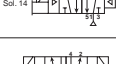
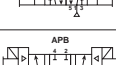
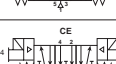
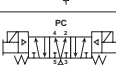
5599-2, Plug-in, Size 3 (H3)

	Symbol	Type	Cv	Operator	Voltage	Pilot	Non-locking	Locking
Modulflex Series		4-way, 2-position, spring return	6.0	Single solenoid	24 VDC	Internal	H3EVXBG0B9D	H3EVXBH0B9D
		External	H3EVXXG0B9D	H3EVXXH0B9D				
		4-way, 2-position, air return	6.0	Single solenoid	24 VDC	Internal	H31VXBG0B9D	H31VXBH0B9D
		External	H31VXXG0B9D	H31VXXH0B9D				
		4-way, 2-position	6.0	Double solenoid	24 VDC	Internal	H32VXBG0B9D	H32VXBH0B9D
		External	H32VXXG0B9D	H32VXXH0B9D				
Isys Micro Series		4-way, 3-position, all ports blocked	5.0	Double solenoid	24 VDC	Internal	H35VXBG0B9D	H35VXBH0B9D
		External	H35VXXG0B9D	H35VXXH0B9D				
		4-way, 3-position, center exhaust	5.0	Double solenoid	24 VDC	Internal	H36VXBG0B9D	H36VXBH0B9D
		External	H36VXXG0B9D	H36VXXH0B9D				
		4-way, 3-position, pressure center	5.0	Double solenoid	24 VDC	Internal	H37VXBG0B9D	H37VXBH0B9D
		External	H37VXXG0B9D	H37VXXH0B9D				
Isys ISO Series		4-way, 2-position, spring return	6.0	Single solenoid	120 VAC	Internal	H3EVXBG023D	H3EVXBH023D
		External	H3EVXXG023D	H3EVXXH023D				
		4-way, 2-position, air return	6.0	Single solenoid	120 VAC	Internal	H31VXBG023D	H31VXBH023D
		External	H31VXXG023D	H31VXXH023D				
		4-way, 2-position	6.0	Double solenoid	120 VAC	Internal	H32VXBG023D	H32VXBH023D
		External	H32VXXG023D	H32VXXH023D				
Fieldbus Series		4-way, 3-position, all ports blocked	5.0	Double solenoid	120 VAC	Internal	H35VXBG023D	H35VXBH023D
		External	H35VXXG023D	H35VXXH023D				
		4-way, 3-position, center exhaust	5.0	Double solenoid	120 VAC	Internal	H36VXBG023D	H36VXBH023D
		External	H36VXXG023D	H36VXXH023D				
		4-way, 3-position, pressure center	5.0	Double solenoid	120 VAC	Internal	H37VXBG023D	H37VXBH023D
		External	H37VXXG023D	H37VXXH023D				



5599-2, Plug-in Single Subbase, Size 3 (H3)

Side ported base	Enclosure / Lead length	Solenoid addresses	3/4" NPT	3/4" BSPP
	Terminal strip in base	Double solenoid - 2 address	PS42119CCP	PS401110CCP
	6" flying leads	Double solenoid - 2 addresses	PS42119ACP	PS421110ACP





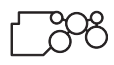
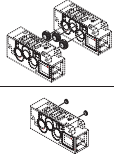

5599-2, Plug-in Manifold Bases, Size 3 (H3)

Bottom / End ported bases	Enclosure / Lead length	Solenoid addresses	3/4" NPT	3/4" BSPP
	Circuit board	Single solenoid - 1 address	PS421169JCP	PS421160JCP
	Circuit board	Double solenoid - 2 addresses	PS421169MCP	PS421160MCP
	Terminal strip in base	Double solenoid - 2 address	PS421169CCP	PS421160CCP
	6" flying leads	Double solenoid - 2 addresses	PS421169ACP	PS421160ACP
End Ported	Enclosure / Lead length	Solenoid addresses	3/4" NPT	3/4" BSPP
	Circuit board	Single solenoid - 1 address	PS421159JCP	PS421150JCP
	Circuit board	Double solenoid - 2 addresses	PS421159MCP	PS421150MCP
	Terminal strip in base	Double solenoid - 2 address	PS421159CCP	PS421150CCP
	6" flying leads	Double solenoid - 2 addresses	PS421159ACP	PS421150ACP

5599-2, Size 3 (H3) Accessories

Accessory	Description	Part number
 Sandwich regulator	Common pressure 5-125 PSIG w/ gauge	PS4238166CP
	Independent pressure 5-125 PSIG w/ gauge	PS4238266CP
 Blanking plate kit		PS4234CP
 Sandwich flow control		PS4235CP
 Manifold to manifold gasket kits		PS4213P
 Manifold port isolation kit	Main galley (1, 3, 5)	PS4232CP
	Pilot galley	PS4033CP

Plug-in, 5599-2 End Plate Kits, Size 3 (H3)

Electrical option	NPT port	BSPP port
 No connector - use with individually wired base	PS4231010DP	PS4231011DP
 25-pin, D-sub	PS4220L20DP	PS4220L21DP
 19-pin, round, Brad Harrison	PS4220L30DP	PS4220L31DP
 12-pin, M23	PS4220L40DP	PS4220L41DP
	19-pin, M23	PS4220M20DP
 Moduflex fieldbus	PS4220M40DP	PS4220M41DP
 Isysnet, with valve driver module	PS4220L60DP	PS4220L61DP
 Turck fieldbus with valve driver module - 16 outputs	PS4220T10DP	PS4220T11DP
	Turck fieldbus with valve driver module - 24 outputs	PS4220T20DP

Turck, Isysnet, and Moduflex communication modules must be ordered separately. See Fieldbus Section for more information.

Note:
 For cable part numbers and pin out information see Fieldbus System Accessories.

Moduflex Series

Isys Micro Series

Isys ISO Series

Fieldbus

DX ISOMAX Series

Valvair II Series

D

Subbase & Manifold Valve Products

How To Order Plug-in Add-A-Fold Assemblies

1. List Add-A-Fold Assembly call out. This automatically includes the end plate kit assembly.
2. List complete Valve, Regulator, Flow Control and Base model number. List left to right, LOOKING AT THE CYLINDER PORTS on the #12 end of the manifold. The left most station is station 1. (If a blanking plate part number and the individual manifold number in the station specified.)

Example

Application requires a 3-Station manifold with a valve and regulator on Station 3.

Item	Qty.	Part No.	Location
01	1	AAH3D003	
02	1	H31VXBG0B9D.....	Station 1
03	1	PS421159MCP.....	Station 1
04	1	H32VXBG0B9D.....	Station 2
05	1	PS421159MCP.....	Station 2
06	1	H32VXXG0B9D.....	Station 3
07	1	PS4238166CP.....	Station 3
08	1	PS421159MCP.....	Station 3

NOTE: Construct manifold assemblies from left to right while looking at the cylinder ports.
 Valves must be ordered as External Pilot when using Sandwich Regulator.

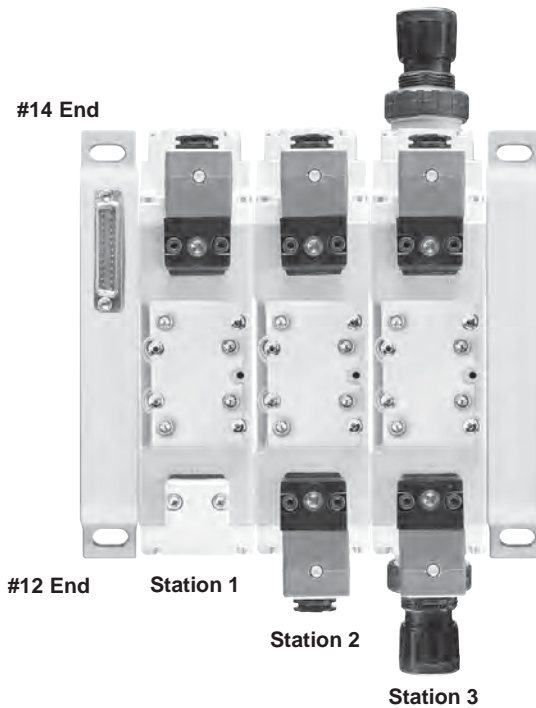

Example:
3-Station Manifold with (3) H3 Valves on Manifold Bases and Regulator at Station 3

Maximum Number of Solenoids (Maximum energized simultaneously)

Voltage	Voltage code	25-pin D-sub	19-pin M23 or		Modulflex Isysnet	Turck		
			Brad Harrison	12-pin M23		16 Outputs	32 Outputs	
24VDC	G9	24 (24)	16 (16)	8 (8)	16 (16)	24 (21)	16 (16)	24 (21)
120VAC*	23	24 (24)	16 (16)	8 (8)	N/A	N/A	N/A	N/A

* Not CSA certified for 25-pin, D-Sub option.

Add-A-Fold Assembly Model Numbers

AA	H3	D	0	03
Valve series	Right & left end plate	End plate type	Number of stations	Thread type
H3	H3	Turck fieldbus with valve driver module - 16 outputs A* Turck fieldbus with valve driver module - 32 outputs B* 25-pin, D-sub D† 19-pin, brad harrison E† 12-pin, M23 G† 19-pin, M23 H† Standard, non-collective wiring S Modulflex fieldbus T* Isysnet, with valve driver module Y*	01 02 03 04 • • 24	0 NPT 1* BSPP "G"

* Must order communication modules separately.
 † Collective wiring module included.

* BSPP Conforms to ISO 1179-1 w 228-1 Threads.

Modulflex Series
 Isys Micro Series
 Isys ISO Series
 Fieldbus Series
 DX ISOMAX Series
 Valvair II Series
D
 Subbase & Manifold Valve Products

Plug-in, 5599-2, Size 1, 2, & 3

H1 E VX B G O B9 D

Basic series 5599-2	
ISO 5599-2 Size 1	H1
ISO 5599-2 Size 2	H2
ISO 5599-2 Size 3	H3

5599-2 Engineering level	
D	Current

5599-2 Operator / Function	
Single solenoid, 2-position - air return	1
Double solenoid, 2-position	2
Double solenoid, 3-position - APB	5
Double solenoid, 3-position - CE	6
Double solenoid, 3-position - PC	7
Single solenoid, 2-position - air return, spring assist	E

5599-2 Voltage & Frequency				
	AC		DC	Light & surge suppression
	60Hz	50Hz		
42	24			
45			12	
B9			24	LED & suppression
23	120	115		LED & suppression
57	240			

5599-2 Mounting	
5599-2 Valve less vase	VX

5599-2 Enclosure / Lead length	
0	None, valve less base

5599-2 Pilot source / Pilot exhaust	
Internal pilot, port #1 / vented	B
External pilot, port #12 or #14 / vented	X*

* Must be specified when using Sandwich Regulators.

5599-2 Overrides / Lights		
	Voltage code	
B	42, 45, 57	Non-locking, flush, push - w/o light
C	42, 45, 57	Locking, flush, push / turn - w/o light
G	B9, 23	Non-locking, flush, push - w/ light
H	B9, 23	Locking, flush, push / turn - w/ light

Plug-in, 5599-2 Transition Plate Kits

PS4026 L2 0 C P

Transition plate type*	
H1 to H2 to H3	PS4025
H1 to H3	PS4026
H1 to H2	PS4027
H2 to H3	PS4028

* Includes Left Hand and Right Hand End Plates

Engineering level	
C	Basic series PS40

Thread type	
0	NPT
1*	BSPP "G"

* BSPP conforms to ISO 1179-1 w 228-1 threads.





Options	
25-pin, D-sub	L2
19-pin, round, brad harrison	L3
12-pin, M23	L4
19-pin, M23	M2
Modulflex fieldbus	M4*
Isysnet, with valve driver module	L6*
Turck fieldbus with valve driver module - 16 outputs	T1
Turck fieldbus with valve driver module - 32 outputs	T2

* Must order communication module separately
 turck, isysnet, and modulflex communication modules must be ordered separately.
 See fieldbus section for more information.



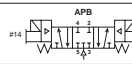

Modulflex Series
Isys Micro Series
Isys ISO Series
Fieldbus
DX ISOMAX Series
Valvair II Series
D
Subbase & Manifold Valve Products

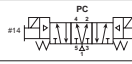
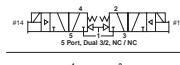
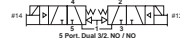



15407-1, Non Plug-in, Size 18mm (HB)

	Symbol	Type	Cv	Operator	Voltage	Pilot	Non-locking	Locking
Modulflex Series		4-way, 2-position, spring return	0.55	Single solenoid	24 VDC	Internal	HBEWXBG2G9000FA	HBEWXBH2G9000FA
						External	HBEWXLG2G9000FA	HBEWXLH2G9000FA
		4-way, 2-position, air return	0.55	Single solenoid	24 VDC	Internal	HB1WXBG2G9000FA	HB1WXBH2G9000FA
						External	HB1WXLG2G9000FA	HB1WXLH2G9000FA
Isys Micro Series		4-way, 2-position	0.55	Double solenoid	24 VDC	Internal	HB2WXBG2G9000FA	HB2WXBH2G9000FA
						External	HB2WXLG2G9000FA	HB2WXLH2G9000FA
		4-way, 3-position, all ports blocked	0.5	Double solenoid	24 VDC	Internal	HB5WXBG2G9000FA	HB5WXBH2G9000FA
						External	HB5WXLG2G9000FA	HB5WXLH2G9000FA
		4-way, 3-position, center exhaust	0.5	Double solenoid	24 VDC	Internal	HB6WXBG2G9000FA	HB6WXBH2G9000FA
						External	HB6WXLG2G9000FA	HB6WXLH2G9000FA
		4-way, 3-position, pressure center	0.5	Double solenoid	24 VDC	Internal	HB7WXBG2G9000FA	HB7WXBH2G9000FA
						External	HB7WXLG2G9000FA	HB7WXLH2G9000FA
Isys ISO Series		3-way, 2-position, dual valve, NC/NC	0.45	Double solenoid	24 VDC	Internal	HBNWXBG2G9000FA	HBNWXBH2G9000FA
						Internal	HBPWXBG2G9000FA	HBPWXBH2G9000FA
Isys ISO Series		3-way, 2-position, dual valve, NO/NO	0.45	Double solenoid	24 VDC	Internal	HBNWXBG2G9000FA	HBNWXBH2G9000FA
						Internal	HBPWXBG2G9000FA	HBPWXBH2G9000FA



15407-1, Non Plug-in, Size 18mm (HB)

	Description	1/8" NPT	1/8" BSPP
Single subbase	Side ported base	PL02-01-80	PL02-01-70
			
2 Station manifold bases	End ported bases	PS5611510P	PS5611520P
			
End plate kit	Non-collective wiring end plate	PS5631010P	PS5631011P
			

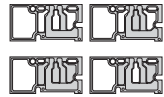

15407-1, Non-Plug-in, Size 18mm (HB) Accessories

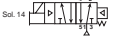
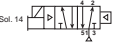
Accessories	Description	Part number
	Common pressure	2-60 PSIG w/ gauge PS5637155P
	Common pressure	5-125 PSIG w/ gauge PS5637166P
	Independent pressure	2-60 PSIG w/ gauge PS5637255P
	Independent pressure	5-125 PSIG w/ gauge PS5637266P
Gauge adapter kit	Includes 1/8" coupling and long nipple	PS5651160P
Blanking plate kit		PS5634P
	1/8" NPT	PS562600P
	1/8" BSPP	PS562601P
	1/8" NPT	PS562700P
	1/8" BSPP	PS562701P
	Intermediate air supply module	1/8" NPT D02P-01-80
	Sandwich flow control	PS5642P
	Standard	PS561AP
	Blocked #1 port	PS561BP
	Blocked #1, 3, 5, ports	PS561CP
	Blocked #3, 5 ports	PS561DP

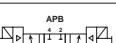
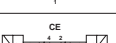
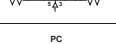





15407-1, Non Plug-in, Size 26mm (HA)

Symbol	Type	Cv	Operator	Voltage	Pilot	Non-locking	Locking
	4-way, 2-position, spring return	1.1	Single solenoid	24 VDC	Internal	HAEWXBG2G9000FA	HAEWXBH2G9000FA
					External	HAEWXLG2G9000FA	HAEWXLH2G9000FA
	4-way, 2-position, air return	1.1	Single solenoid	24 VDC	Internal	HA1WXBG2G9000FA	HA1WXBH2G9000FA
					External	HA1WXLG2G9000FA	HA1WXLH2G9000FA
	4-way, 2-position	1.1	Double solenoid	24 VDC	Internal	HA2WXBG2G9000FA	HA2WXBH2G9000FA
					External	HA2WXLG2G9000FA	HA2WXLH2G9000FA
	4-way, 3-position, all ports blocked	1.0	Double solenoid	24 VDC	Internal	HA5WXBG2G9000FA	HA5WXBH2G9000FA
					External	HA5WXLG2G9000FA	HA5WXLH2G9000FA
	4-way, 3-position, center exhaust	1.0	Double solenoid	24 VDC	Internal	HA6WXBG2G9000FA	HA6WXBH2G9000FA
					External	HA6WXLG2G9000FA	HA6WXLH2G9000FA
	4-way, 3-position, pressure center	1.0	Double solenoid	24 VDC	Internal	HA7WXBG2G9000FA	HA7WXBH2G9000FA
					External	HA7WXLG2G9000FA	HA7WXLH2G9000FA

15407-1, Non Plug-in, Size 26mm (HA)

Single subbase	Description	1/4" NPT	1/4" BSPP
	Side ported base	PL01-02-80	PL01-02-70
2 Station manifold bases	Description	1/4" NPT	1/4" BSPP
	End ported bases	PS5511530P	PS5511540P
End plate kit	Description	NPT port	BSPP port
	Non-collective wiring end plate	PS5631010P	PS5631011P

15407-1, Non-Plug-in, Size 18mm (HB) Accessories

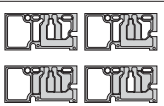
Accessories	Description	Part number
	Common pressure	2-60 PSIG w/ gauge PS5537155P
	Common pressure	5-125 PSIG w/ gauge PS5537166P
	Independent pressure	2-60 PSIG w/ gauge PS5537255P
	Independent pressure	5-125 PSIG w/ gauge PS5537266P
	Gauge adapter kit	Includes 1/8" coupling and long nipple PS5651160P
	Blanking plate kit	PS5634P
	1/8" NPT	PS562600P
	1/8" BSPP	PS562601P
	1/8" NPT	PS562700P
	1/8" BSPP	PS562701P
	Intermediate air supply module	1/8" NPT D01P-02-80
	Sandwich flow control	PS5542P
	Standard	PS561AP
	Blocked #1 port	PS561BP
	Blocked #1, 3, 5, ports	PS561CP
	Blocked #3, 5 ports	PS561DP

Non Plug-in, 15407-1, Size 18mm (HB) & 26mm (HA)

Modulflex Series
 Isys Micro Series
 Isys ISO Series
 Fieldbus Series
 DX ISOMAX Series
 Valvair II Series
 D Subbase & Manifold Valve Products

HB E WX B G 2 G9 000F A

Basic series 15407-1	
ISO 15407-1 18mm	HB
ISO 15407-1 26mm	HA

15407-1 Operator / Function	
Single solenoid, 2-position - air return	1
Double solenoid, 2-position	2
Double solenoid, 3-position - APB	5
Double solenoid, 3-position - CE	6
Double solenoid, 3-position - PC	7
Single solenoid, 2-position - air return, spring assist	E
Double solenoid, dual 3/2, NC/NC	N†
Double solenoid, dual 3/2, NO/NO	P†
Double solenoid, dual 3/2, 14 end NC – 12 end NO	Q†

15407-1 Mounting	
Valve less base	WX

15407-1 Overrides / Lights	
G	Non-locking, flush, push - w/ light
H	Locking, flush, push / turn - w/ light

15407-1 Pilot source / Pilot exhaust	
B	Internal pilot, port #1 / vented
L*	External pilot, port #14 / vented

15407-1 Enclosure / Lead length	
2	4-pin, M12 micro, straight connector

15407-1 Voltage & frequency		
G9	24VDC	LED & suppression

15407-1 Central connector wiring options	
000F	SAE / Ford, ISO 20401

15407-1 Engineering level	
A	Current

† Available on HB Only, must use Internal Pilot Source Option "B".

* Must be specified when using Sandwich Regulators.

How To Order 15407-1 Non Plug-in Add-A-Fold Assemblies

1. List Add-A-Fold Assembly call out. This automatically includes the end plate kit assembly.
2. List complete Valve, Regulator, Flow Control and Base model number. List left to right, LOOKING AT THE CYLINDER PORTS on the #12 end of the manifold. The left most station is station 1. (If a blank station is needed, list the blanking plate part number and the individual manifold number in the station specified.)

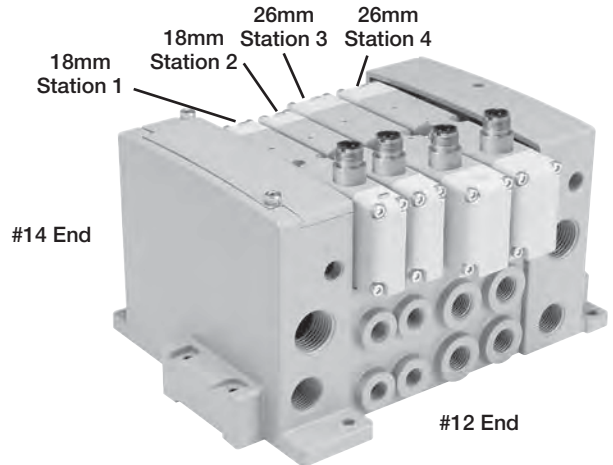

Example:
 4-Station Manifold with (2) 18mm and (2) 26mm Valves on Manifold Bases

Add-A-Fold Assembly Model Number

AA HBS 0 04

Valve series	
Right & left end plate 15407-1 (HB 18mm & HA 26mm)	HBS†

Number of stations*	
02	
04	
•	
24	
•	
32	

Thread type	
NPT	0
BSPP "G"	1*

† For use with PS5511 and PS5611 manifolds.

* Must be ordered in multiples of (2) unless using the HB/HA to H2 transition plate.

* BSPP conforms to ISO 1179-1 w 228-1 threads for end plate Type "S".

Example



Application requires a 4-Station manifold. (Two 18mm + Two 26mm Stations)

Item	Qty.	Part No.	Location
01	1	AAHBS004	
02	1	1HB1WXBG2G9000FA	Station 1
03	1	1HB2WXBG2G9000FA	Station 2
04	1	1PS5611510P	Station 1 & 2
05	2	2HA1WXBG2G9000FA	Station 3 & 4
06	1	1PS5511510P	Station 3 & 4

NOTE: Construct manifold assemblies from left to right while looking at the ports. Valves must be ordered as External Pilot when using Sandwich Regulator.

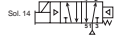
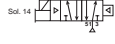
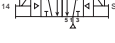
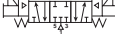
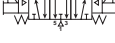

5599-1, Non Plug-in, Size 1 (H1) with Central Connectors

Symbol	Type	Cv	Operator	Voltage	Enclosure	Pilot	Non-locking	Locking
	4-way, 2-position, spring return	1.5	Single solenoid	24 VDC	4-pin, central M12 connector	Internal	H1EWXBG2B9000FD	H1EWXBH2B9000FD
						External	H1EWXXG2B9000FD	H1EWXXH2B9000FD
	4-way, 2-position, air return	1.5	Single solenoid	24 VDC	4-pin, central M12 connector	Internal	H11WXBG2B9000FD	H11WXBH2B9000FD
						External	H11WXXG2B9000FD	H11WXXH2B9000FD
	4-way, 2-position	1.5	Double solenoid	24 VDC	4-pin, central M12 connector	Internal	H12WXBG2B9000FD	H12WXBH2B9000FD
						External	H12WXXG2B9000FD	H12WXXH2B9000FD
	4-way, 3-position, all ports blocked	1.2	Double solenoid	24 VDC	4-pin, central M12 connector	Internal	H15WXBG2B9000FD	H15WXBH2B9000FD
						External	H15WXXG2B9000FD	H15WXXH2B9000FD
	4-way, 3-position, center exhaust	1.2	Double solenoid	24 VDC	4-pin, central M12 connector	Internal	H16WXBG2B9000FD	H16WXBH2B9000FD
						External	H16WXXG2B9000FD	H16WXXH2B9000FD
	4-way, 3-position, pressure center	1.2	Double solenoid	24 VDC	4-pin, central M12 connector	Internal	H17WXBG2B9000FD	H17WXBH2B9000FD
						External	H17WXXG2B9000FD	H17WXXH2B9000FD

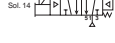
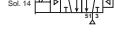
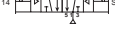
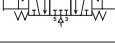
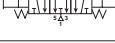
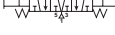
Symbol	Type	Cv	Operator	Voltage	Enclosure	Pilot	Non-locking	Locking
	4-way, 2-position, spring return	1.5	Single solenoid	120 VAC	5-Pin, central 7/8" mini connector	Internal	H1EWXBG323000FD	H1EWXBH323000FD
						External	H1EWXXG323000FD	H1EWXXH323000FD
	4-way, 2-position, air return	1.5	Single solenoid	120 VAC	5-Pin, central 7/8" mini connector	Internal	H11WXBG323000FD	H11WXBH323000FD
						External	H11WXXG323000FD	H11WXXH323000FD
	4-way, 2-position	1.5	Double solenoid	120 VAC	5-Pin, central 7/8" mini connector	Internal	H12WXBG323000FD	H12WXBH323000FD
						External	H12WXXG323000FD	H12WXXH323000FD
	4-way, 3-position, all ports blocked	1.2	Double solenoid	120 VAC	5-Pin, central 7/8" mini connector	Internal	H15WXBG323000FD	H15WXBH323000FD
						External	H15WXXG323000FD	H15WXXH323000FD
	4-way, 3-position, center exhaust	1.2	Double solenoid	120 VAC	5-Pin, central 7/8" mini connector	Internal	H16WXBG323000FD	H16WXBH323000FD
						External	H16WXXG323000FD	H16WXXH323000FD
	4-way, 3-position, pressure center	1.2	Double solenoid	120 VAC	5-Pin, central 7/8" mini connector	Internal	H17WXBG323000FD	H17WXBH323000FD
						External	H17WXXG323000FD	H17WXXH323000FD

Modulflex Series

Isys Micro Series

Isys ISO Series

Fieldbus Series





DX ISOMAX Series

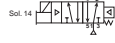

Valvair II Series

D

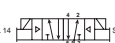
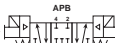

Subbase & Manifold Valve Products

5599-1, Non Plug-in, Size 1 (H1) with 3-Pin DIN Connectors

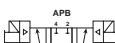
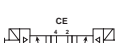
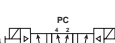





	Symbol	Type	Cv	Operator	Voltage	Enclosure	Pilot	Non-locking	Locking
Modulflex Series		4-way, 2-position, spring return	1.5	Single solenoid	24 VDC	3-pin DIN connector on coil	Internal	H1EWXBBL49D	H1EWXBDL49D
		4-way, 2-position, air return	1.5	Single solenoid	24 VDC	3-pin DIN connector on coil	External	H1EWXXBL49D	H1EWXXDL49D
		4-way, 2-position, air return	1.5	Single solenoid	24 VDC	3-pin DIN connector on coil	Internal	H11WXBBL49D	H11WXBDL49D
		4-way, 2-position, air return	1.5	Single solenoid	24 VDC	3-pin DIN connector on coil	External	H11WXXBL49D	H11WXXDL49D
		4-way, 2-position	1.5	Double solenoid	24 VDC	3-pin DIN connector on coil	Internal	H12WXBBL49D	H12WXBDL49D
		4-way, 2-position	1.5	Double solenoid	24 VDC	3-pin DIN connector on coil	External	H12WXXBL49D	H12WXXDL49D
Isys Micro Series		4-way, 3-position, all ports blocked	1.2	Double solenoid	24 VDC	3-pin DIN connector on coil	Internal	H15WXBBL49D	H15WXBDL49D
		4-way, 3-position, center exhaust	1.2	Double solenoid	24 VDC	3-pin DIN connector on coil	External	H15WXXBL49D	H15WXXDL49D
		4-way, 3-position, center exhaust	1.2	Double solenoid	24 VDC	3-pin DIN connector on coil	Internal	H16WXBBL49D	H16WXBDL49D
		4-way, 3-position, center exhaust	1.2	Double solenoid	24 VDC	3-pin DIN connector on coil	External	H16WXXBL49D	H16WXXDL49D
Isys ISO Series		4-way, 3-position, pressure center	1.2	Double solenoid	24 VDC	3-pin DIN connector on coil	Internal	H17WXBBL49D	H17WXBDL49D
		4-way, 3-position, pressure center	1.2	Double solenoid	24 VDC	3-pin DIN connector on coil	External	H17WXXBL49D	H17WXXDL49D

	Symbol	Type	Cv	Operator	Voltage	Enclosure	Pilot	Non-locking	Locking
Fieldbus Series		4-way, 2-position, spring return	1.5	Single solenoid	120 VAC	3-pin DIN connector on coil	Internal	H1EWXBBL53D	H1EWXBDL53D
		4-way, 2-position, air return	1.5	Single solenoid	120 VAC	3-pin DIN connector on coil	External	H1EWXXBL53D	H1EWXXDL53D
		4-way, 2-position, air return	1.5	Single solenoid	120 VAC	3-pin DIN connector on coil	Internal	H11WXBBL53D	H11WXBDL53D
		4-way, 2-position, air return	1.5	Single solenoid	120 VAC	3-pin DIN connector on coil	External	H11WXXBL53D	H11WXXDL53D
		4-way, 2-position	1.5	Double solenoid	120 VAC	3-pin DIN connector on coil	Internal	H12WXBBL53D	H12WXBDL53D
		4-way, 2-position	1.5	Double solenoid	120 VAC	3-pin DIN connector on coil	External	H12WXXBL53D	H12WXXDL53D
DX ISOMAX Series		4-way, 3-position, all ports blocked	1.2	Double solenoid	120 VAC	3-pin DIN connector on coil	Internal	H15WXBBL53D	H15WXBDL53D
		4-way, 3-position, all ports blocked	1.2	Double solenoid	120 VAC	3-pin DIN connector on coil	External	H15WXXBL53D	H15WXXDL53D
		4-way, 3-position, center exhaust	1.2	Double solenoid	120 VAC	3-pin DIN connector on coil	Internal	H16WXBBL53D	H16WXBDL53D
		4-way, 3-position, center exhaust	1.2	Double solenoid	120 VAC	3-pin DIN connector on coil	External	H16WXXBL53D	H16WXXDL53D
Valvair II Series		4-way, 3-position, pressure center	1.2	Double solenoid	120 VAC	3-pin DIN connector on coil	Internal	H17WXBBL53D	H17WXBDL53D
		4-way, 3-position, pressure center	1.2	Double solenoid	120 VAC	3-pin DIN connector on coil	External	H17WXXBL53D	H17WXXDL53D

5599-1, Non Plug-in, Size 1 (H1)

	Single subbase	Description	3/8" NPT	3/8" BSPP
		Side ported base	PS4011150CP	PS4011160CP
	Manifold bases	Description	3/8" NPT	3/8" BSPP
		End ported bases	PS4011550CP	PS4011560CP
		Bottom / end ported bases	PS4011650CP	PS4011660CP
	End plate kits	Description	NPT port	BSPP port
		H1 Non-collective wiring end plates	PS4031010CP	PS4031011CP

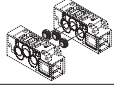
5599-1, Non Plug-in, Size 1 (H1) Accessories

Accessory	Description	Part number
 Sandwich regulator	Common pressure	5-125 PSIG w/ gauge PS4037166CP
	Independent pressure	5-125 PSIG w/ gauge PS4037266CP
 Blanking plate kit		PS4034CP
 Sandwich flow control		PS4042CP
 Manifold to manifold gasket kits		PS4013P
 Manifold port isolation kit	Main galley (1, 3, 5)	PS4032CP
	Pilot galley	PS4033CP
 Auxiliary access plate kit	1/4" & 3/8"	NPT PS403000CP
		BSPP PS403001CP

Modulflex
Series

Isys Micro
Series

Isys ISO
Series

Fieldbus

DX ISOMAX
Series

Valvair II
Series

D

Subbase & Manifold
Valve Products

How To Order Non Plug-in Add-A-Fold Assemblies

1. List Add-A-Fold Assembly call out. This automatically includes the end plate kit assembly.
2. List complete Valve, Regulator, Flow Control and Base model number. List left to right, LOOKING AT THE CYLINDER PORTS on the #12 end of the manifold. The left most station is station 1. (If a blank station is needed, list the blanking plate part number and the individual manifold number in the station specified.)

Example

Application requires a 3-Station manifold with a valve, regulator on Station 3.

Item	Qty.	Part No.	Location
01	1	AAH1S003	
02	1	H11WXBG2B9000FD	Station 1
03	1	PS4011550CP	Station 1
04	1	H12WXBG2B9000FD	Station 2
05	1	PS4011550CP	Station 2
06	1	H12WXXG2B9000FD	Station 3
07	1	PS4037166CP	Station 3
08	1	PS4011550CP	Station 3

NOTE: Construct manifold assemblies from left to right while looking at the cylinder ports.
 Valves must be ordered as External Pilot when using Sandwich Regulator.

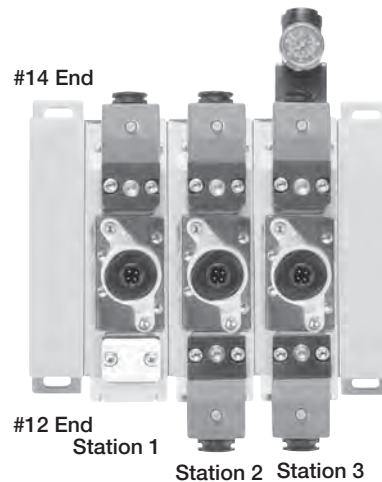

Example:
 3-Station Manifold with (3) H1 Valves on Manifold Bases and Regulator at Station 3





Add-A-Fold Assembly Model Number





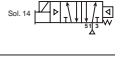

AA	H1	S	0	03	
Valve series		End plate type		Transition plate	
Right & left end plate H1		Standard - non-collective wiring S		Blank No transition plate	
Thread type		Number of stations		C H1 to H2	
NPT 0		01		D H1 to H3	
BSPP "G" 1*		02			
		03			
		04			
		•			
		•			
		24			

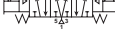
* BSPP Conforms to ISO 1179-1 w 228-1 Threads.

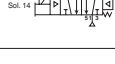

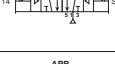



Modulflex Series
Isys Micro Series
Isys ISO Series
Fieldbus
DX ISOMAX Series
Valvair II Series
D
Subbase & Manifold Valve Products

5599-1, Non Plug-in, Size 2 (H2) with Central Connectors

Symbol	Type	Cv	Operator	Voltage	Enclosure	Pilot	Non-locking	Locking
	4-way, 2-position, spring return	3.0	Single solenoid	24 VDC	4-pin, central M12 connector	Internal	H2EWXBG2B9000FD	H2EWXBH2B9000FD
						External	H2EWXXG2B9000FD	H2EWXXH2B9000FD
	4-way, 2-position, air return	3.0	Single solenoid	24 VDC	4-pin, central M12 connector	Internal	H21WXBG2B9000FD	H21WXBH2B9000FD
						External	H21WXXG2B9000FD	H21WXXH2B9000FD
	4-way, 2-position	3.0	Double solenoid	24 VDC	4-pin, central M12 connector	Internal	H22WXBG2B9000FD	H22WXBH2B9000FD
						External	H22WXXG2B9000FD	H22WXXH2B9000FD
	4-way, 3-position, all ports blocked	2.8	Double solenoid	24 VDC	4-pin, central M12 connector	Internal	H25WXBG2B9000FD	H25WXBH2B9000FD
						External	H25WXXG2B9000FD	H25WXXH2B9000FD
	4-way, 3-position, center exhaust	2.8	Double solenoid	24 VDC	4-pin, central M12 connector	Internal	H26WXBG2B9000FD	H26WXBH2B9000FD
						External	H26WXXG2B9000FD	H26WXXH2B9000FD
	4-way, 3-position, pressure center	2.8	Double solenoid	24 VDC	4-pin, central M12 connector	Internal	H27WXBG2B9000FD	H27WXBH2B9000FD
						External	H27WXXG2B9000FD	H27WXXH2B9000FD

Symbol	Type	Cv	Operator	Voltage	Enclosure	Pilot	Non-locking	Locking
	4-way, 2-position, spring return	3.0	Single solenoid	120 VAC	5-Pin, central 7/8" mini connector	Internal	H2EWXBG323000FD	H2EWXBH323000FD
						External	H2EWXXG323000FD	H2EWXXH323000FD
	4-way, 2-position, air return	3.0	Single solenoid	120 VAC	5-Pin, central 7/8" mini connector	Internal	H21WXBG323000FD	H21WXBH323000FD
						External	H21WXXG323000FD	H21WXXH323000FD
	4-way, 2-position	3.0	Double solenoid	120 VAC	5-Pin, central 7/8" mini connector	Internal	H22WXBG323000FD	H22WXBH323000FD
						External	H22WXXG323000FD	H22WXXH323000FD
	4-way, 3-position, all ports blocked	2.8	Double solenoid	120 VAC	5-Pin, central 7/8" mini connector	Internal	H25WXBG323000FD	H25WXBH323000FD
						External	H25WXXG323000FD	H25WXXH323000FD
	4-way, 3-position, center exhaust	2.8	Double solenoid	120 VAC	5-Pin, central 7/8" mini connector	Internal	H26WXBG323000FD	H26WXBH323000FD
						External	H26WXXG323000FD	H26WXXH323000FD
	4-way, 3-position, pressure center	2.8	Double solenoid	120 VAC	5-Pin, central 7/8" mini connector	Internal	H27WXBG323000FD	H27WXBH323000FD
						External	H27WXXG323000FD	H27WXXH323000FD

5599-1, Non Plug-in, Size 2 (H2) with 3-Pin DIN Connectors

Symbol	Type	Cv	Operator	Voltage	Enclosure	Pilot	Non-locking	Locking
	4-way, 2-position, spring return	3.0	Single solenoid	24 VDC	3-pin DIN connector on coil	Internal	H2EWXBBL49D	H2EWXBCL49D
						External	H2EWXXBL49D	H2EWXXCL49D
	4-way, 2-position, air return	3.0	Single solenoid	24 VDC	3-pin DIN connector on coil	Internal	H21WXBBL49D	H21WXBCL49D
						External	H21WXXBL49D	H21WXXCL49D
	4-way, 2-position	3.0	Double solenoid	24 VDC	3-pin DIN connector on coil	Internal	H22WXBBL49D	H22WXBCL49D
						External	H22WXXBL49D	H22WXXCL49D
	4-way, 3-position, all ports blocked	2.8	Double solenoid	24 VDC	3-pin DIN connector on coil	Internal	H25WXBBL49D	H25WXBCL49D
						External	H25WXXBL49D	H25WXXCL49D
	4-way, 3-position, center exhaust	2.8	Double solenoid	24 VDC	3-pin DIN connector on coil	Internal	H26WXBBL49D	H26WXBCL49D
						External	H26WXXBL49D	H26WXXCL49D
	4-way, 3-position, pressure center	2.8	Double solenoid	24 VDC	3-pin DIN connector on coil	Internal	H27WXBBL49D	H27WXBCL49D
						External	H27WXXBL49D	H27WXXCL49D

Modulflex Series

Isys Micro Series

Isys ISO Series

Fieldbus Series

DX ISOMAX Series

Valvair II Series

D



Subbase & Manifold Valve Products



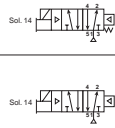
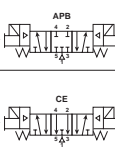
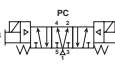



5599-1, Non Plug-in, Size 2 (H2) with 3-Pin DIN Connectors

	Symbol	Type	Cv	Operator	Voltage	Enclosure	Pilot	Non-locking	Locking
Modulflex Series		4-way, 2-position, spring return	3.0	Single solenoid	120 VAC	3-pin DIN connector on coil	Internal	H2EWXBBL53D	H2EWXBCL53D
		4-way, 2-position, air return	3.0	Single solenoid	120 VAC	3-pin DIN connector on coil	External	H2EWXXBBL53D	H2EWXXCL53D
							Internal	H21WXBBL53D	H21WXBCL53D
External	H21WXXBBL53D	H21WXXCL53D							
Isys Micro Series		4-way, 3-position, all ports blocked	2.8	Double solenoid	120 VAC	3-pin DIN connector on coil	Internal	H25WXBBL53D	H25WXBCL53D
		4-way, 3-position, center exhaust	2.8	Double solenoid	120 VAC	3-pin DIN connector on coil	External	H25WXXBBL53D	H25WXXCL53D
							Internal	H26WXBBL53D	H26WXBCL53D
External	H26WXXBBL53D	H26WXXCL53D							
Isys ISO Series		4-way, 3-position, pressure center	2.8	Double solenoid	120 VAC	3-pin DIN connector on coil	Internal	H27WXBBL53D	H27WXBCL53D
		External	H27WXXBBL53D	H27WXXCL53D					

5599-1, Non Plug-in, Size 2 (H2)

	Single subbase	Description	1/2" NPT	1/2" BSPP
Fieldbus		Side ported base	PS4111170CP	PS4111180CP
		Manifold bases	PS4111570CP	PS4111580CP
DX ISOMAX Series		End ported bases	PS4111670CP	PS4111680CP
		Bottom / end ported bases	PS4111670CP	PS4111680CP
		Note: Manifolds include 2 pipe plugs		
Valvair II Series		End plate kits	NPT port	BSPP port
		H2 Non-collective wiring end plates	PS4131010CP	PS4131011CP

5599-1, Non Plug-in, Size 2 (H2) Accessories

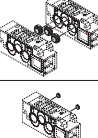
	Accessory	Description	Part number
	Sandwich regulator	Common pressure 5-125 PSIG w/ gauge	PS4137166CP
		Independent pressure 5-125 PSIG w/ gauge	PS4137266CP
	Blanking plate kit		PS4134CP
	Sandwich flow control		PS4142CP
	Manifold to manifold gasket kits		PS4113P
	Manifold port isolation kit	Main galley (1, 3, 5)	PS4132CP
		Pilot galley	PS4033CP

How To Order Non Plug-in Add-A-Fold Assemblies

1. List Add-A-Fold Assembly call out. This automatically includes the end plate kit assembly.
2. List complete Valve, Regulator, Flow Control and Base model number. List left to right, LOOKING AT THE CYLINDER PORTS on the #12 end of the manifold. The left most station is station 1. (If a blank station is needed, list the blanking plate part number and the individual manifold number in the station specified.)

Example

Application requires a 3-Station manifold with a valve and regulator on Station 3.

Item	Qty.	Part No.	Location
01	1	AAH2S003	
02	1	H21WXBG2B9000FD	Station 1
03	1	PS4111570CP	Station 1
04	1	H22WXBG2B9000FD	Station 2
05	1	PS4111570CP	Station 2
06	1	H22WXXG2B9000FD	Station 3
07	1	PS4137166CP	Station 3
08	1	PS4111570CP	Station 3

NOTE: Construct manifold assemblies from left to right while looking at the cylinder ports.
 Valves must be ordered as External Pilot when using Sandwich Regulator.

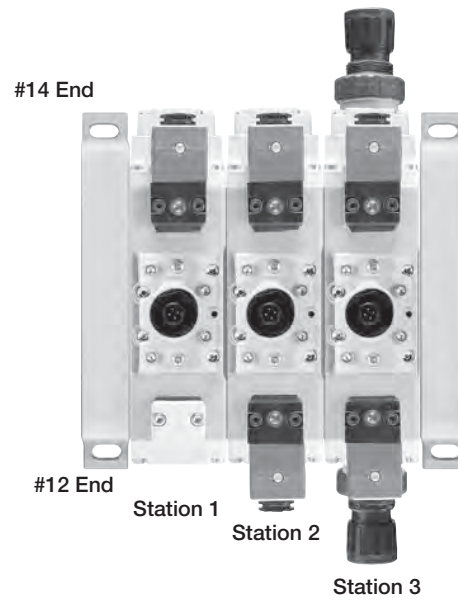

Example:
 3-Station Manifold with (3) H2 Valves on Manifold Bases and Regulator at Station 3

Add-A-Fold Assembly Model Number

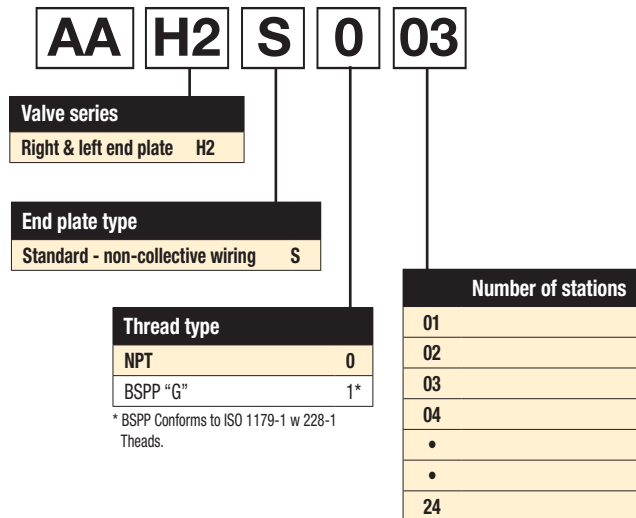

Modulflex Series

Isys Micro Series

Isys ISO Series

Fieldbus



DX ISOMAX Series

Valvair II Series

D

Subbase & Manifold Valve Products

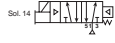
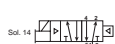
5599-1, Non Plug-in, Size 3 (H3) with Central Connectors

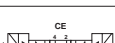
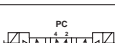
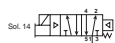
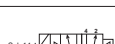
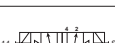
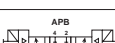
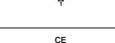
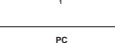

	Symbol	Type	Cv	Operator	Voltage	Enclosure	Pilot	Non-locking	Locking
Modulflex Series		4-way, 2-position, spring return	6.0	Single solenoid	24 VDC	4-pin, central M12 connector	Internal	H3EWXBG2B9000FD	H3EWXBH2B9000FD
		External	H3EWXG2B9000FD	H3EWXH2B9000FD					
		4-way, 2-position, air return	6.0	Single solenoid	24 VDC	4-pin, central M12 connector	Internal	H31WXBG2B9000FD	H31WXBH2B9000FD
		External	H31WXXG2B9000FD	H31WXXH2B9000FD					
		4-way, 2-position	6.0	Double solenoid	24 VDC	4-pin, central M12 connector	Internal	H32WXBG2B9000FD	H32WXBH2B9000FD
		External	H32WXXG2B9000FD	H32WXXH2B9000FD					
Isys Micro Series		4-way, 3-position, all ports blocked	5.0	Double solenoid	24 VDC	4-pin, central M12 connector	Internal	H35WXBG2B9000FD	H35WXBH2B9000FD
		External	H35WXXG2B9000FD	H35WXXH2B9000FD					
		4-way, 3-position, center exhaust	5.0	Double solenoid	24 VDC	4-pin, central M12 connector	Internal	H36WXBG2B9000FD	H36WXBH2B9000FD
		External	H36WXXG2B9000FD	H36WXXH2B9000FD					
Isys ISO Series		4-way, 3-position, pressure center	5.0	Double solenoid	24 VDC	4-pin, central M12 connector	Internal	H37WXBG2B9000FD	H37WXBH2B9000FD
		External	H37WXXG2B9000FD	H37WXXH2B9000FD					
	Symbol	Type	Cv	Operator	Voltage	Enclosure	Pilot	Non-locking	Locking
Fieldbus Series		4-way, 2-position, spring return	6.0	Single solenoid	120 VAC	5-Pin, central 7/8" mini connector	Internal	H3EWXBG323000FD	H3EWXBH323000FD
		External	H3EWXG323000FD	H3EWXH323000FD					
		4-way, 2-position, air return	6.0	Single solenoid	120 VAC	5-Pin, central 7/8" mini connector	Internal	H31WXBG323000FD	H31WXBH323000FD
		External	H31WXXG323000FD	H31WXXH323000FD					
		4-way, 2-position	6.0	Double solenoid	120 VAC	5-Pin, central 7/8" mini connector	Internal	H32WXBG323000FD	H32WXBH323000FD
		External	H32WXXG323000FD	H32WXXH323000FD					
DX ISOMAX Series		4-way, 3-position, all ports blocked	5.0	Double solenoid	120 VAC	5-Pin, central 7/8" mini connector	Internal	H35WXBG323000FD	H35WXBH323000FD
		External	H35WXXG323000FD	H35WXXH323000FD					
		4-way, 3-position, center exhaust	5.0	Double solenoid	120 VAC	5-Pin, central 7/8" mini connector	Internal	H36WXBG323000FD	H36WXBH323000FD
		External	H36WXXG323000FD	H36WXXH323000FD					
Valvair II Series		4-way, 3-position, pressure center	5.0	Double solenoid	120 VAC	5-Pin, central 7/8" mini connector	Internal	H37WXBG323000FD	H37WXBH323000FD
		External	H37WXXG323000FD	H37WXXH323000FD					

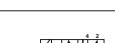
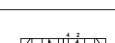
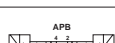
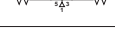
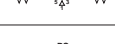
5599-1, Non Plug-in, Size 3 (H3) with 3-Pin DIN Connectors



	Symbol	Type	Cv	Operator	Voltage	Enclosure	Pilot	Non-locking	Locking
Subbase & Manifold		4-way, 2-position, spring return	6.0	Single solenoid	24 VDC	3-pin DIN connector on coil	Internal	H3EWXBBL49D	H3EWXBCL49D
		External	H3EWXBL49D	H3EWXCL49D					
		4-way, 2-position, air return	6.0	Single solenoid	24 VDC	3-pin DIN connector on coil	Internal	H31WXBBL49D	H31WXBCL49D
		External	H31WXXBL49D	H31WXXCL49D					
		4-way, 2-position	6.0	Double solenoid	24 VDC	3-pin DIN connector on coil	Internal	H32WXBBL49D	H32WXBCL49D
		External	H32WXXBL49D	H32WXXCL49D					
Subbase & Manifold		4-way, 3-position, all ports blocked	5.0	Double solenoid	24 VDC	3-pin DIN connector on coil	Internal	H35WXBBL49D	H35WXBCL49D
		External	H35WXXBL49D	H35WXXCL49D					
		4-way, 3-position, center exhaust	5.0	Double solenoid	24 VDC	3-pin DIN connector on coil	Internal	H36WXBBL49D	H36WXBCL49D
		External	H36WXXBL49D	H36WXXCL49D					
Subbase & Manifold		4-way, 3-position, pressure center	5.0	Double solenoid	24 VDC	3-pin DIN connector on coil	Internal	H37WXBBL49D	H37WXBCL49D
		External	H37WXXBL49D	H37WXXCL49D					

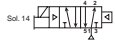
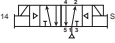
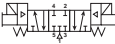

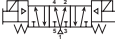



5599-1, Non Plug-in, Size 3 (H3) with 3-Pin DIN Connectors

Symbol	Type	Cv	Operator	Voltage		Pilot	Non-locking	Locking
	4-way, 2-position, spring return	6.0	Single solenoid	120 VAC	3-pin DIN connector on coil	Internal	H3EWXBBL53D	H3EWXBCL53D
						External	H3EWXXBBL53D	H3EWXXCL53D
	4-way, 2-position, air return	6.0	Single solenoid	120 VAC	3-pin DIN connector on coil	Internal	H31WXBBL53D	H31WXBCL53D
						External	H31WXXBBL53D	H31WXXCL53D
	4-way, 2-position	6.0	Double solenoid	120 VAC	3-pin DIN connector on coil	Internal	H32WXBBL53D	H32WXBCL53D
						External	H32WXXBBL53D	H32WXXCL53D
	4-way, 3-position, all ports blocked	5.0	Double solenoid	120 VAC	3-pin DIN connector on coil	Internal	H35WXBBL53D	H35WXBCL53D
						External	H35WXXBBL53D	H35WXXCL53D
	4-way, 3-position, center exhaust	5.0	Double solenoid	120 VAC	3-pin DIN connector on coil	Internal	H36WXBBL53D	H36WXBCL53D
						External	H36WXXBBL53D	H36WXXCL53D
	4-way, 3-position, pressure center	5.0	Double solenoid	120 VAC	3-pin DIN connector on coil	Internal	H37WXBBL53D	H37WXBCL53D
						External	H37WXXBBL53D	H37WXXCL53D

5599-1, Non Plug-in, Size 3 (H3)

Single subbase	Description	3/4" NPT	3/4" BSPP
	Side ported base	PS4211190CP	PS4211180CP
Manifold bases	Description	3/4" NPT	3/4" BSPP
	End ported bases	PS4211590CP	PS4211500CP
	Bottom / end ported bases	PS4211690CP	PS4211600CP
	Note: Manifolds include 2 pipe plugs		
End plate kits	Description	NPT port	BSPP port
	H3 Non-collective wiring end plates	PS4231010CP	PS4231011CP

5599-1, Non Plug-in, Size 3 (H3) Accessories

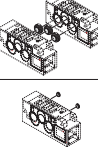
Accessory	Description	Part number
	Common pressure 5-125 PSIG w/ gauge	PS4237166CP
	Independent pressure 5-125 PSIG w/ gauge	PS4237266CP
	Blanking plate kit	PS4234CP
	Sandwich flow control	PS4242CP
	Manifold to manifold gasket kits	PS4213P
	Main galley (1, 3, 5)	PS4232CP
	Pilot galley	PS4033CP

Modulflex Series

Isys Micro Series

Isys ISO Series

Fieldbus

DX ISOMAX Series

Valvair II Series

D
Subbase & Manifold Valve Products

How To Order Non Plug-in Add-A-Fold Assemblies

1. List Add-A-Fold Assembly call out. This automatically includes the end plate kit assembly.
2. List complete Valve, Regulator, Flow Control and Base model number. List left to right, LOOKING AT THE CYLINDER PORTS on the #12 end of the manifold. The left most station is station 1. (If a blank station is needed, list the blanking plate part number and the individual manifold number in the station specified.)

Example

Application requires a 3-Station manifold with a valve and regulator on Station 3.

Item	Qty.	Part No.	Location
01	1	AAH3S003	
02	1	H31WXBG2B9000FD	Station 1
03	1	PS4211590CP	Station 1
04	1	H32WXBG2B9000FD	Station 2
05	1	PS4211590CP	Station 2
06	1	H32WXXG2B9000FD	Station 3
07	1	PS4237166CP	Station 3
08	1	PS4211590CP	Station 3

NOTE: Construct manifold assemblies from left to right while looking at the cylinder ports.
 Valves must be ordered as External Pilot when using Sandwich Regulator.

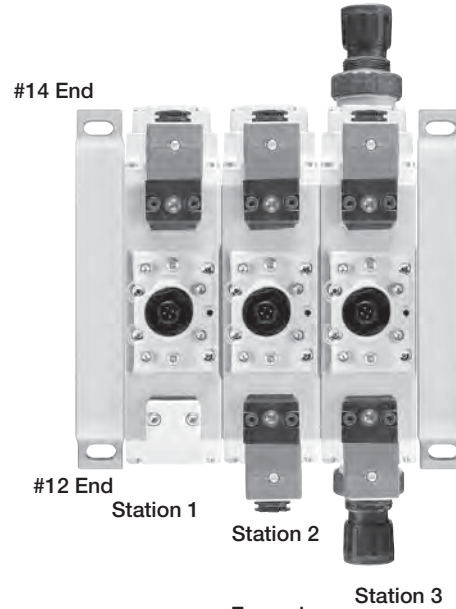

Example:
 3-Station Manifold with (3) H3 Valves
 on Manifold Bases and Regulator at Station 3

Add-A-Fold Assembly Model Number

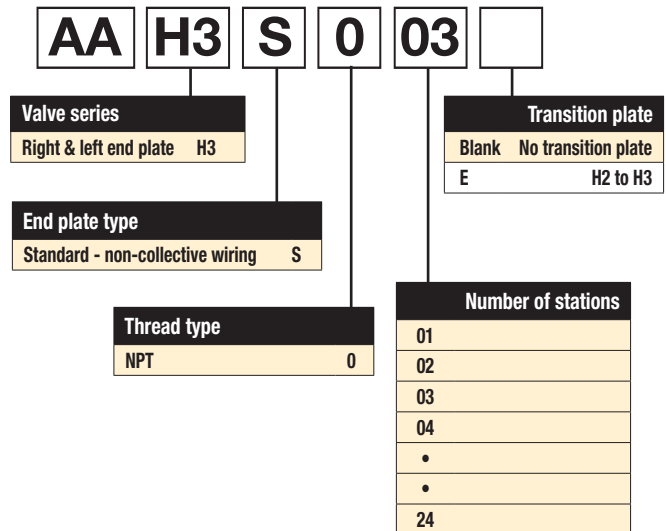

5599-1 Non Plug-in Transition Plate Kits

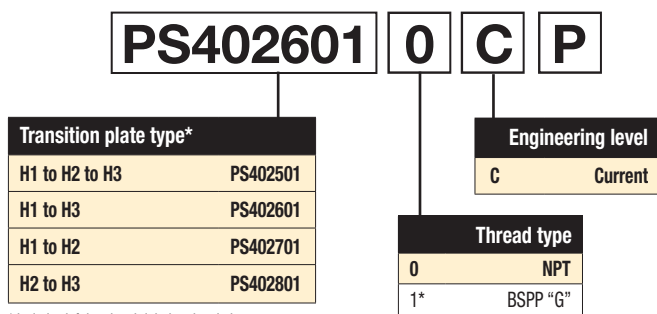

* Includes left hand and right hand end plates.
 Use with PS4... series manifolds only.

* BSPP conforms to ISO 1179-1
 w 228-1 threads.



Non Plug-in, 5599-1, Central Connector - Size 1, 2, & 3

Basic series 5599-1	
ISO 5599-1 Size 1	H1
ISO 5599-1 Size 2	H2
ISO 5599-1 Size 3	H3

5599-1 Operator / Function	
Single solenoid, 2-position - air return	1
Double solenoid, 2-position	2
Double solenoid, 3-position - APB	5
Double solenoid, 3-position - CE	6
Double solenoid, 3-position - PC	7
Single solenoid, 2-position - air return, spring assist	E

5599-1 Mounting	
Valve less base	WX

5599-1 Pilot source / Pilot exhaust	
Internal pilot, port #1 / vented	B
External pilot, port #12 or #14 / vented	X*

5599-1 Overrides / Lights	
Non-locking, flush, with light	G
Locking, flush, with light	H

5599-1 Engineering level	
D	Current

5599-1 Central connector wiring options	
000C	Chrysler
000F*	SAE / Ford, ISO 20401
000G	General Motors

* Complies to ISO 20401 with Enclosure Lead Length "2".

Enclosure / Lead length / Voltage*				
	AC		DC	
	60Hz	50Hz		
1B9 [†]			24	3-pin, central mini connector
123 [†]	120	115		3-pin, central mini connector
2B9			24	4-pin, central M12 connector
3B9			24	5-pin, central mini connector
323	120	115		5-pin, central mini connector
619 [†]			24	2-pin, M12 connector on coil

* All coils include LED & suppression
[†] Operator function "1" or "E"
* Only available with wiring option "000F"

Non Plug-in, 5599-1, CNOMO - Size 1, 2, & 3

Basic series 5599-1	
ISO 5599-1 Size 1	H1
ISO 5599-1 Size 2	H2
ISO 5599-1 Size 3	H3

5599-1 Operator / Function	
Single solenoid, 2-position - air return	1
Double solenoid, 2-position	2
Double solenoid, 3-position - APB	5
Double solenoid, 3-position - CE	6
Double solenoid, 3-position - PC	7
Single solenoid, 2-position - air return, spring assist	E

5599-1 Mounting	
Valve less base	WX

5599-1 Pilot source / Pilot exhaust	
Internal pilot, port #1 / vented	B
External pilot, port #12 or #14 / vented	X*

5599-1 Engineering level	
D	Current

Enclosure / Lead length / Voltage				
	AC		DC	
	60Hz	50Hz		
L42	24			3-pin, 30mm DIN 43650A with CNOMO connector
L45			12	3-pin, 30mm DIN 43650A with CNOMO connector
L49			24	3-pin, 30mm DIN 43650A with CNOMO connector
L53	120	115		3-pin, 30mm DIN 43650A with CNOMO connector
L57	240			3-pin, 30mm DIN 43650A with CNOMO connector
NXX				Valve less coil

5599-1 Overrides / Lights	
B	Non-locking, flush, push - no light
C	Locking, flush, push / turn - no light

* Must be specified when using Sandwich Regulators.



Modulflex Series
Isys Micro Series
Isys ISO Series
Fieldbus
DX ISOMAX Series
Valvair II Series
D
Subbase & Manifold Valve Products

Maximum Number of Solenoids
(Maximum energized simultaneously)

	HA & HB	Voltage code	25-pin D-sub					Turck	
				19-pin Brad Harrison	12-Pin M23	19-pin M23	Moduflex	Isysnet	16 Outputs
Moduflex Series	24VDC	G9	24 (24)	16 (16)	8 (8)	16 (16)	16 (16)	32 (32)	16 (16) 32 (32)
	120VAC*	23	24 (24)	16 (16)	8 (8)	16 (16)	N/A	N/A	N/A N/A
Isys Micro Series	H1, H2 & H3	Voltage code	25-pin D-sub	19-pin Brad Harrison	12-Pin M23	19-pin M23	Moduflex	Isysnet	Turck 16 Outputs 32 Outputs
	12VDC	45	24 (13)	16 (13)	8 (8)	16 (13)	N/A	N/A	N/A N/A
	24VAC*	42	24 (24)	16 (16)	8 (8)	16 (16)	N/A	N/A	N/A N/A
	24VDC	B9	24 (20)	16 (16)	8 (8)	16 (16)	16 (16)	24 (21)	16 (16) 24 (21)
	120VAC*	23	24 (24)	16 (16)	8 (8)	16 (16)	N/A	N/A	N/A N/A

* Not CSA certified for 25-pin, D-sub option.

Female Electrical Connectors (IP65 Rated) 30mm, 3-Pin ISO 4400, (DIN 43650A)

	Description	Connector with 6' (2m) cord	Connector
Fieldbus	Unlighted	PS2028JCP	PS2028BP
	Light – 6-48V, 50/60Hz; 6-48VDC	PS2032J79CP*	PS203279BP
	Light – 120V/60Hz	PS2032J83CP*	PS203283BP
	Light – 240V/60Hz	N/A	PS203283BP

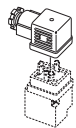

* With surge suppression.

Engineering data:

Conductors: 2 poles plus ground; cable range (connector only): 8 to 10mm (0.31 To 0.39 inch); Contact spacing: 18mm

I/O Addressing Examples

HB & HA Example
Two Station Manifold Bases

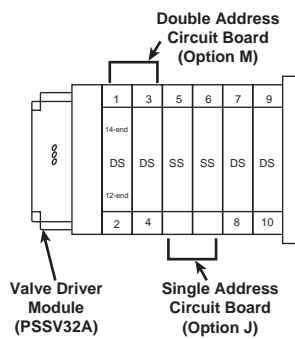

Notes: SS = Single Solenoid Valve
 DS = Double Solenoid Valve
 First output address the #14 end of the valve closest to the valve driver module.

H1, H2 & H3 Example:
Single Station Manifold Bases

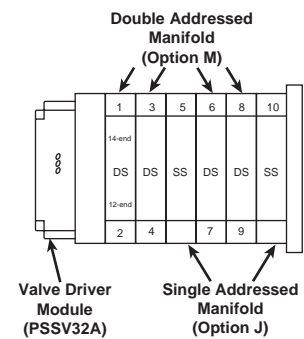

5599-2 & 5599-1 AUTO Solenoid Kits

Valve size	Voltage code	Coil kit number
	42 (24VAC)	PS404142P
	45 (12VDC)	PS404145P
H1, H2 & H3	B9 (24VDC)	PS4041B9P
	23 (120VAC)	PS404123P
	57 (240VAC)	PS404157P

Quantity 1

5599-1 CNOMO Solenoid Kits

Voltage code	3-pin, 30mm 'L' coil kit	2-pin, M12 Euro '6' coil kit
19	—	PS2828619P
42	P2FCA442	—
45	P2FCA445	—
49	P2FCA449	—
53	P2FCA453	—
57	P2FCA457	—

Quantity 1



Pilot Operator - CNOMO

Valve size		Kit number
H1, H2 & H3	Locking	PS4052CP
	Non-locking	PS4053CP

Manifold Hardware Kits – PS Series

Valve size	Kit number
HA & HB	PS5612P
	PS5512P
	PS4012P
H1, H2 & H3	PS4112P
	PS4212P

Quantity 12

Valve Bolt Kits

Valve size	Kit number
HA & HB	PS5687P
	PS5587P
	PS4087DP
H1, H2 & H3	PS4187DP
	PS4287DP

Quantity 12

Valve to Base Gasket Kits

Valve size	Standard	Remote pilot	Dual pressure #3	Dual pressure #5
HA & HB	PS5605P*	—	—	—
	PS5505P*	—	—	—
H1, H2 & H3	PS4005DP	PS4006DP	PS40D3DP	—
	PS4105DP	PS4106DP	PS41D3DP	PS41D5DP
	PS4205DP	PS4206DP	PS42D3DP	PS42D5DP

Quantity 1
 * Quantity 10

Body Service Kits



Valve size	2-position	3-position		
		APB	CE	PC
HA & HB	PS5601P	PS5602P	PS5603P	PS5604P
	PS5501P	PS5502P	PS5503P	PS5504P
H1, H2 & H3	PS4001CP	PS4002CP	PS4003CP	PS4004CP
	PS4101CP	PS4102CP	PS4103CP	PS4104CP
	PS4201CP	PS4202CP	PS4203CP	PS4204CP

HB / HA Kit Includes: Spool assembly with seals.

H1, H2, H3 Kit Includes: Spool assembly with seals, all piston seals, return spring, pilot selector gasket, coil to end cap gasket.

Quantity 1

Pilot Select Gasket Kits

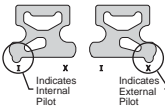
	Valve size	Kit number
	HB	PS5605P
	HA	PS5505P
	H1, H2 & H3	PS4007P

Quantity 10

Modulflex Series

Isys Micro Series

Isys ISO Series

Fieldbus

DX ISOMAX Series

Valvair II Series

D

Subbase & Manifold Valve Products

Isys ISO 15407-2, Plug-in, Size 18mm (HB)

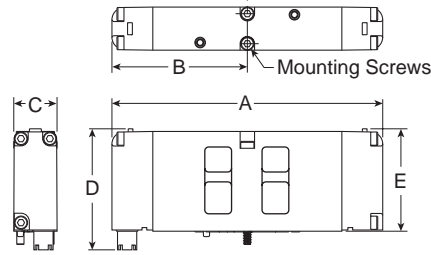

18mm Dimensions

A	B	C	D
4.43	2.22	.72	1.98
(113)	(56)	(18)	(50)

E
 1.68
 (43)

Inches (mm)

Isys ISO 15407-2, Plug-in, Size 26mm (HA)

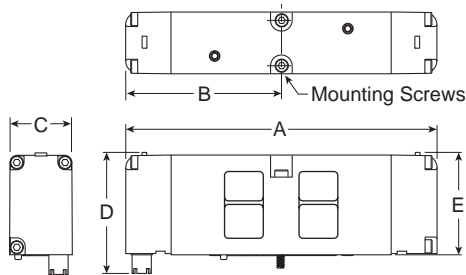

26mm Dimensions

A	B	C	D
5.10	2.55	1.02	1.98
(130)	(65)	(26)	(50)

E
 1.66
 (42)

Inches (mm)

Isys ISO 15407-1, Non Plug-in, Size 18mm (HB)

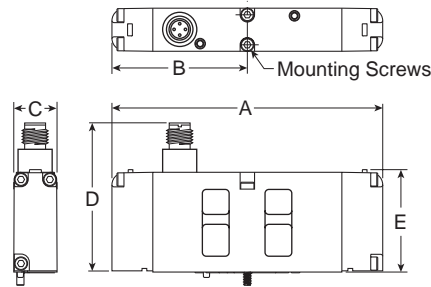

18mm Dimensions

A	B	C	D
4.43	2.22	.72	2.40
(113)	(56)	(18)	(61)

E
 1.68
 (43)

Inches (mm)

Isys ISO 15407-1, Non Plug-in, Size 26mm (HA)

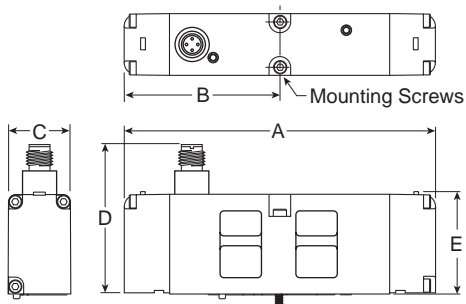

26mm Dimensions

A	B	C	D
5.10	2.55	1.02	2.40
(130)	(65)	(26)	(61)

E
 1.66
 (42)

Inches (mm)

- Modulflex Series
- Isys Micro Series
- Isys ISO Series
- Fieldbus
- DX ISOMAX Series
- Valvair II Series
- D**
- Subbase & Manifold Valve Products

Isys ISO 5599-2

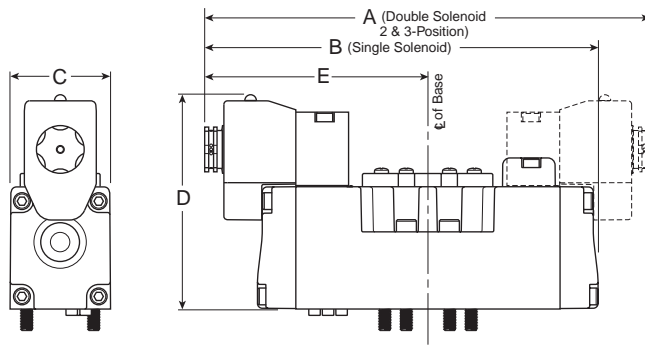

H1 Valves Shown

H1 Dimensions

A	A ₁	B	C
7.32 (186)	5.59 (142)	6.46 (164)	1.65 (42)
D	D ₁	D ₂	D ₃
3.54 (90)	4.29 (109)	4.29 (109)	2.50 (63.5)
D ₄	E	E ₁	
2.48 (63)	3.66 (93)	2.80 (71)	

Inches (mm)

Isys ISO 5599-1 Auto

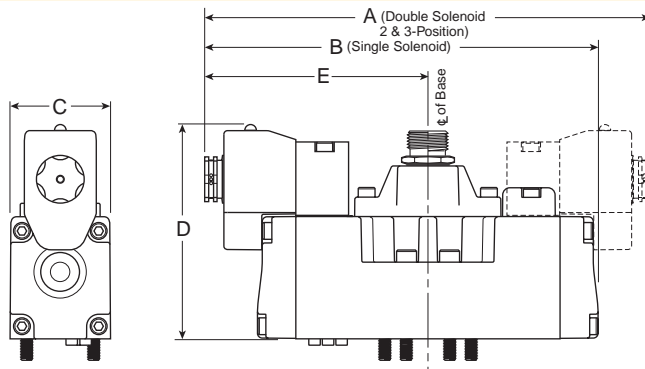

H2 Dimensions

A	A ₁	B	C
8.35 (212)	6.62 (168)	7.48 (190)	2.17 (55)
D	D ₁	D ₂	D ₃
4.05 (103)	4.80 (122)	4.57 (116)	2.99 (76)
E	E ₁		
4.17 (106)	3.31 (84)		

Inches (mm)

Isys ISO 5599-1 CNOMO

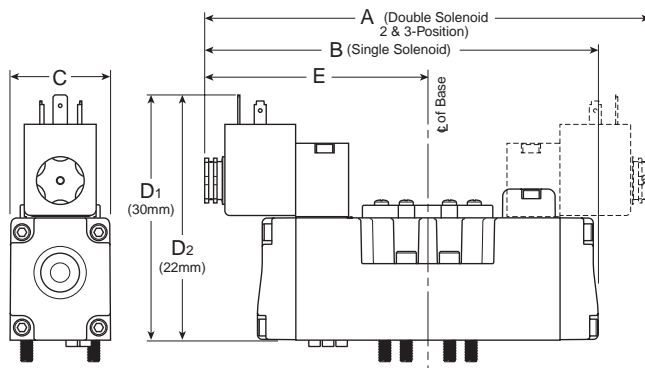

H3 Dimensions

A	A ₁	B	C
9.68 (246)	6.98 (177)	8.68 (220)	2.17 (55)
D	D ₁	D ₂	D ₃
4.05 (103)	4.80 (122)	4.57 (116)	2.99 (76)
E	E ₁		
4.74 (121)	3.49 (89)		

Inches (mm)

Isys ISO 5599-2 / 5599-1 Remote Pilot

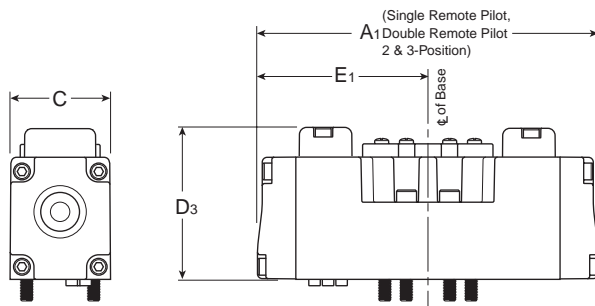

Modulflex Series
Isys Micro Series
Isys ISO Series
Fieldbus
DX ISOMAX Series
Valvair II Series
D
Subbase & Manifold Valve Products

Isys ISO 15407-2 & 15407-1 Size 26mm (HA), Plug-in Subbases

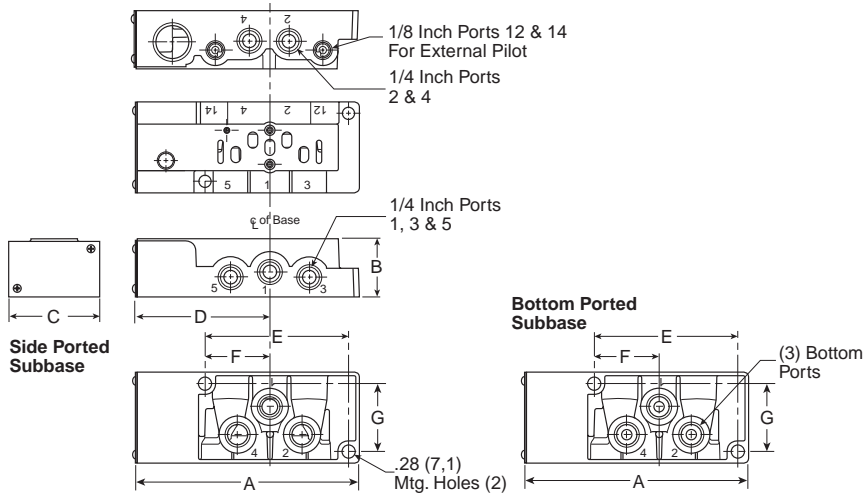

HA Dimensions

A	B	C	D
4.88 (124)	1.28 (32.5)	2.00 (50.8)	2.91 (74)
E	F	G	
1.43 (36.2)	3.16 (80.2)	1.49 (37.9)	

Inches (mm)

Isys ISO Size 18mm (HB) & 26mm (HA), Non-Plug-in Compact Subbase

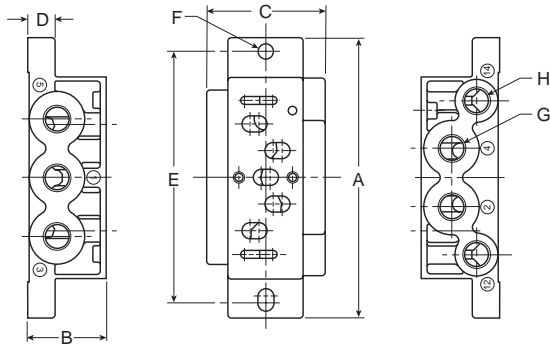

Series	Part number	A	B	C	D	E	F	G	H
HB	PL02	3.15 (80)	.87 (22)	1.06 (27)	.31 (8)	2.76 (70)	.216 Dia. (Ø 5.5)	1/8	M5
HA	PL01	3.94 (100)	1.10 (28)	1.65 (42)	.39 (10)	3.54 (90)	.216 Dia. (Ø 5.5)	1/4	1/8

Inches (mm)

Isys ISO 15407-2 & 15407-1 Size 18mm (HB) & 26mm (HA), PS5611 & PS5511 Manifolds

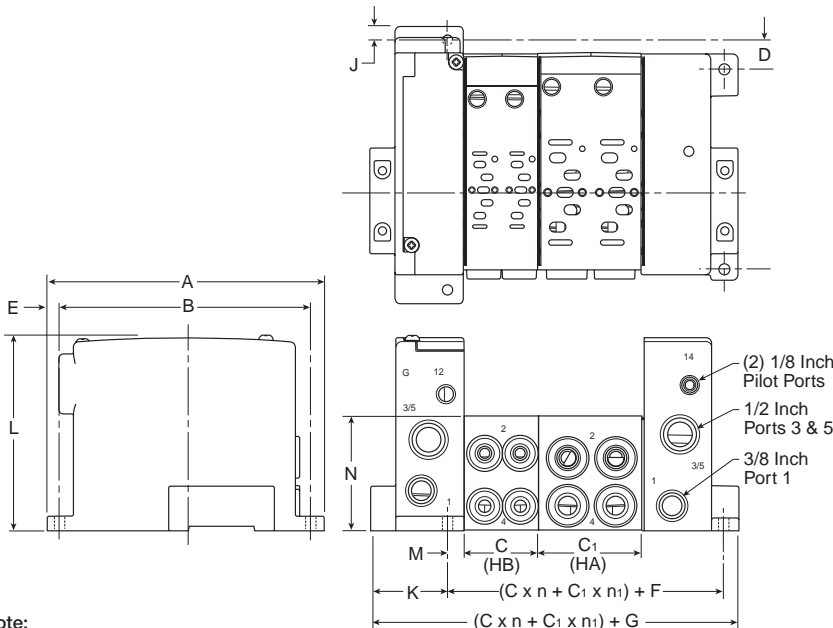

HB & HA Dimensions

A	B	C	C ₁	D	E
5.98 (152)	5.39 (137)	1.61 (40.8)	2.24 (56.8)	.63 (16)	.30 (7.5)
F	G	H	J	K	L
2.14 (54.4)	4.12 (104.6)	4.32 (109.8)	.15 (4)	1.68 (42.7)	4.17 (106)
M	N				
.33 (8.4)	2.48 (63)				

Inches (mm)

Note:
 See Fieldbus Section for the dimensions of manifolds utilizing the Isysnet, Turck, or Moduflex end plate type.

n = Number of HB Bases C = HB Series
 n₁ = Number of HA Bases C₁ = HA Series

Isys ISO 5599-1 Size H1, PS4011 Subbase

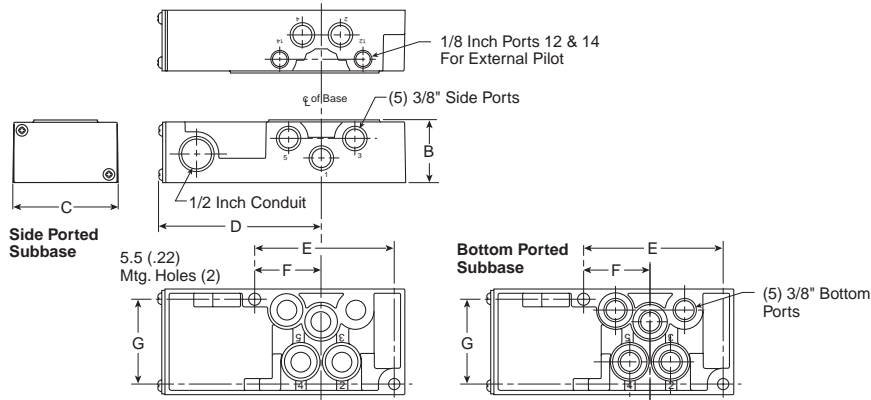

PS4011 Subbase Dimensions

A	B	C	D
5.83	1.48	2.50	3.86
(148)	(38)	(64)	(98)

E	F	G
3.29	1.57	2.00
(84)	(40)	(51)

Inches (mm)

Isys ISO 5599-1 Size H2, PS4111 Subbase

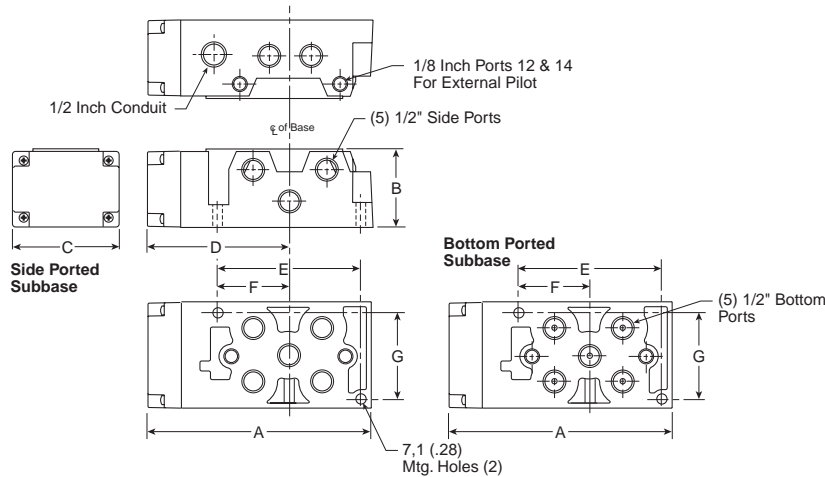

PS4111 Subbase Dimensions

A	B	C	D
6.69	2.33	3.15	4.25
(170)	(59)	(80)	(108)

E	F	G
4.21	2.07	2.56
(107)	(52)	(65)

Inches (mm)

Isys ISO 5599-1 Size H3, PS4211 Subbase

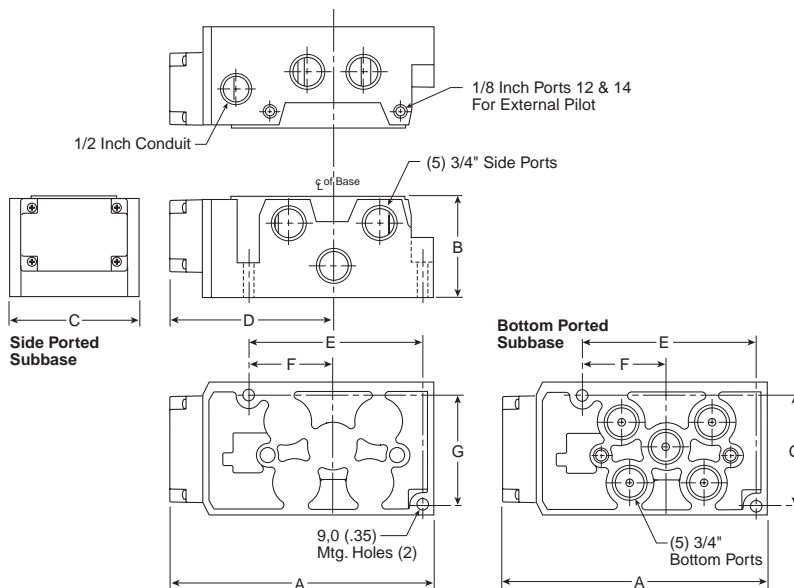

PS4211 Subbase Dimensions

A	B	C	D
7.90	2.96	3.90	4.92
(201)	(75)	(99)	(125)

E	F	G
5.14	2.50	3.24
(131)	(64)	(82)

Inches (mm)

Isys ISO 5599 Size H1, PS4011 Manifold

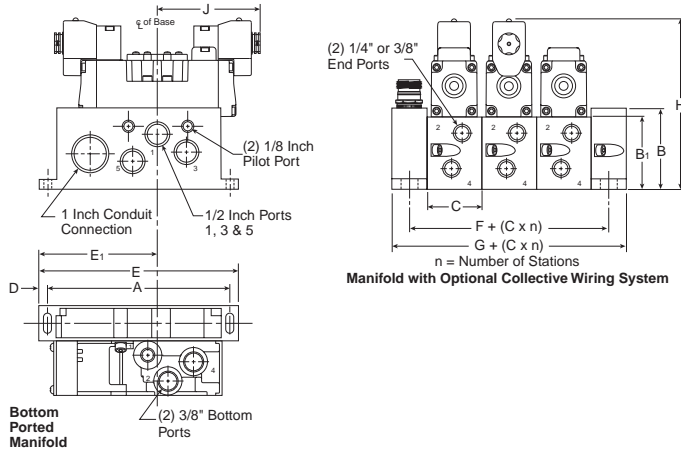

PS4011 Manifold Dimensions

A	B	B ₁	C	D
6.50 (165)	2.87 (73)	2.64 (67)	1.96 (50)	.33 (8)
E	E ₁	F	G	H
7.15 (182)	4.25 (108)	1.25 (32)	2.50 (63.5)	6.18 (157)
J	3.66 (93)			

Inches (mm)

Isys ISO 5599 Size H2, PS4111 Manifold

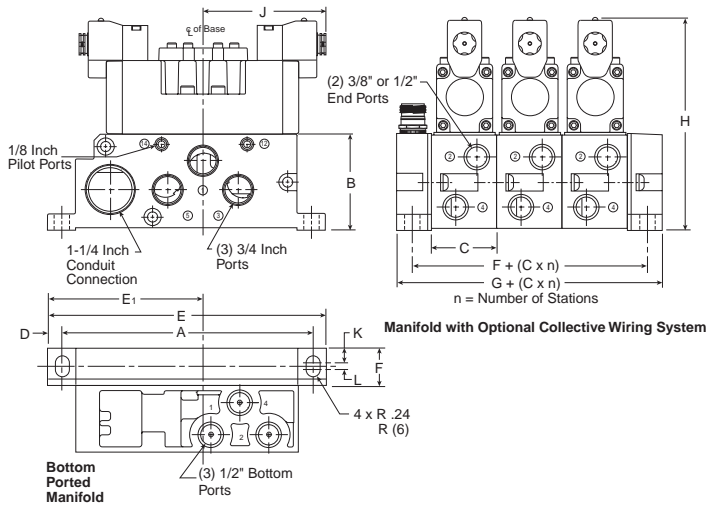

PS4111 Manifold Dimensions

A	B	C	D	E
8.46 (215)	3.35 (85)	2.20 (56)	.47 (12)	9.41 (239)
E ₁	F	G	H	J
5.28 (134)	1.26 (32)	2.60 (63)	7.40 (188)	4.17 (106)
K	L	.65 (16.5)		
.24 (6)	.24 (6)			

Inches (mm)

Isys ISO 5599 Size H3, PS4211 Manifold

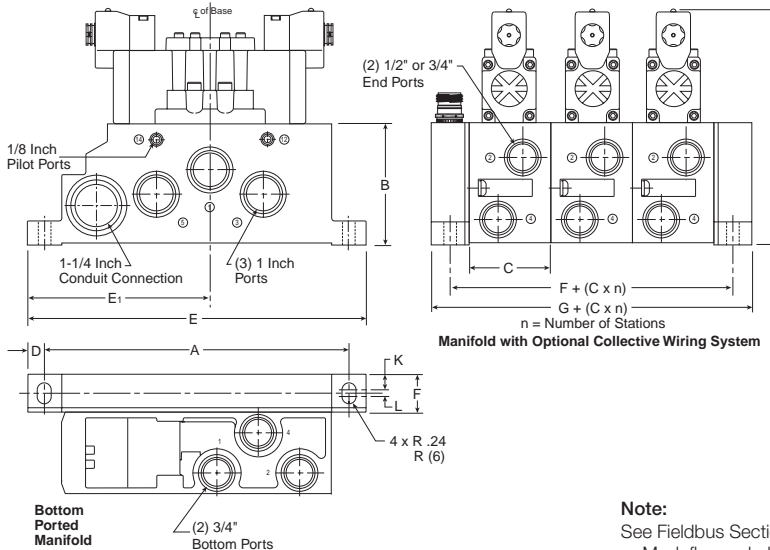

PS4211 Manifold Dimensions

A	B	C	D	E
10.41 (265)	4.13 (105)	2.80 (71)	.59 (15)	11.61 (295)
E ₁	F	G	H	
6.26 (159)	1.30 (33)	2.60 (63)	8.19 (208)	
K	L	.53 (13.5)		
.24 (6)	.24 (6)			

Inches (mm)

Note:

See Fieldbus Section for the dimensions of manifolds utilizing the Isysnet, Turck, or Modflex end plate type.

Modflex Series
 Isys Micro Series
 Isys ISO Series
 Fieldbus Series
 DX ISOMAX Series
 Valvair II Series
D Subbase & Manifold Valve Products

Isys ISO 15407 Sandwich Regulator

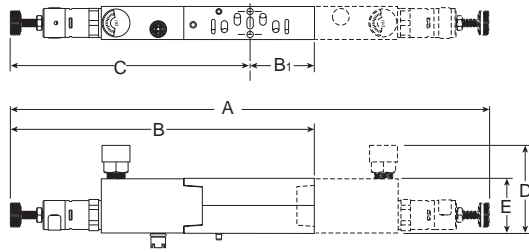

Series	Part number	A	B	B1	C	D	E
HB	PS5637	10.28 (261)	6.14 (156)	1.02 (26)	5.13 (130)	2.60 (66)	1.18 (30)
HA	PS5537	10.00 (254)	6.42 (163)	1.42 (36)	5.00 (127)	2.72 (69)	1.18 (30)

Inches (mm)

Isys ISO 5599, Size H1 Sandwich Regulator

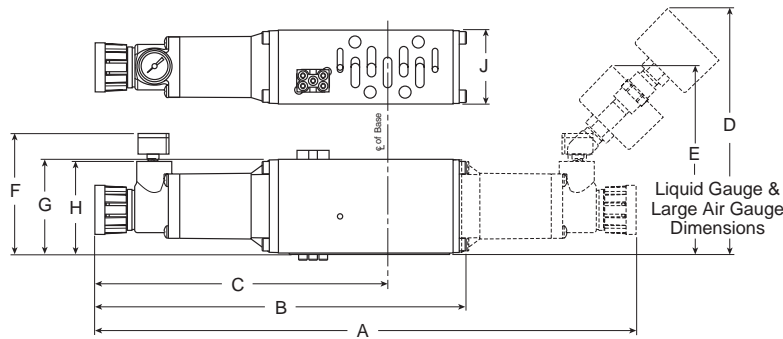

Series	Part number	A	B	C	D	E	F	G	H	J
H1	PS4037	11.84	8.13	6.40	5.45	4.25	2.85	2.09	2.05	1.63
	PS4038	(301)	(207)	(163)	(138)	(108)	(72)	(53)	(52)	(41)

Inches (mm)

Isys ISO 5599, Size H2 & H3 Sandwich Regulator

H2 Sandwich Regulator Shown

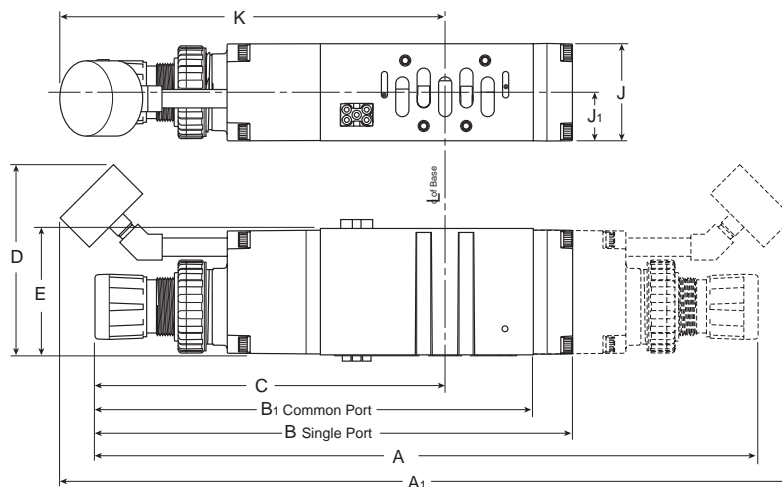

Series	Part number	A	A1	B	B1	C	D	E	J	J1	K
H2	PS4137	14.65	16.18	10.56	9.84	7.71	4.20	2.80	2.15	1.07	8.50
	PS4138	(372)	(411)	(268)	(250)	(196)	(107)	(71)	(55)	(27)	(216)
H3	PS4237	15.67	17.15	11.53	10.67	8.37	4.20	2.93	2.50	1.25	9.10
	PS4238	(398)	(436)	(293)	(271)	(213)	(107)	(75)	(64)	(32)	(231)

Inches (mm)



Isys ISO 15407, Size 18mm (HB) & 26mm (HA), Flow Control

HA Flow Control

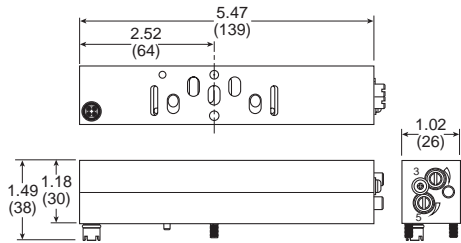

HB Flow Control

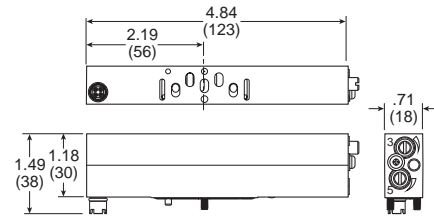

Isys ISO 5599, Size H1, H2 & H3, Flow Control

H1 Flow Control

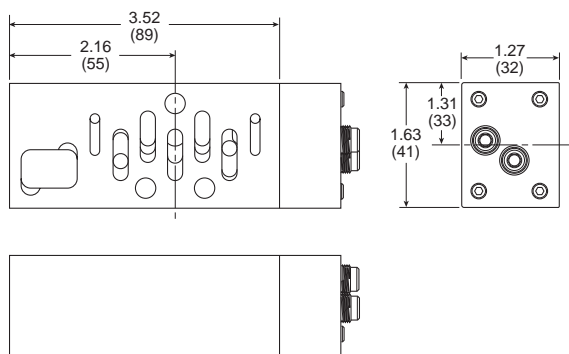

H2 Flow Control

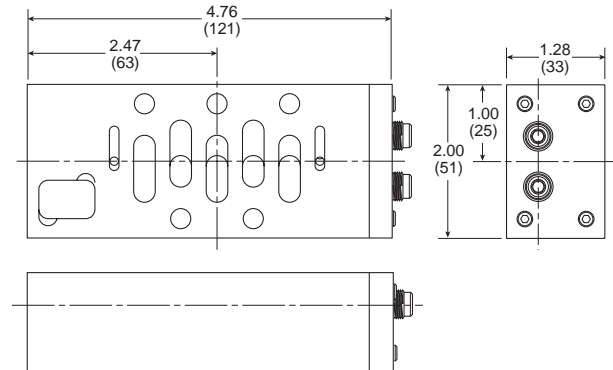

H3 Flow Control

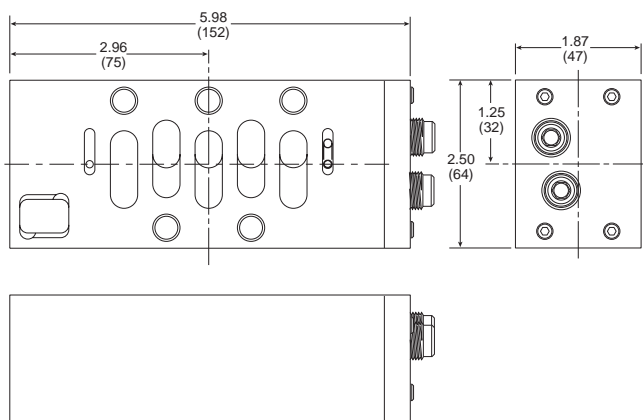

Modulflex Series
Isys Micro Series
Isys ISO Series
Fieldbus
DX ISOMAX Series
Valvair II Series
D
Subbase & Manifold Valve Products