

## Moduflex Series

The Moduflex Valve System redefines flexibility for pneumatic users. Whether configured from basic components or ordered as a pre-assembled and tested valve manifold, Moduflex flexibility is unmatched in the market place.

### Ports

- Size 1: Push-in connectors for 5/32, 1/4 inch, 4, 6mm OD tube
- Size 2: Push-in connectors for 1/4, 3/8, 1/2 inch, 6, 8, 10, 12 mm OD tube

### Mounting

- S Series – Individual subbase
- T Series – Manifold mount with individual connectors
- V Series – Manifold mount with collective wiring or fieldbus

### Fieldbus options

- DeviceNet, Profibus, CANopen, AS-i, Interbus-S

### Solenoids

- 1.0 Watt
- 24 VDC
- Compatible with PNP or NPN outputs

### Certification / approval

- IP65 rated
- CE, as marked

### Material specifications

End plates (T and V series)	Plastic
Fasteners	Nickel plated steel
Spool	Aluminum and nitrile rubber or ceramic plate
Subbase or manifold	Plastic
Valve body	Plastic

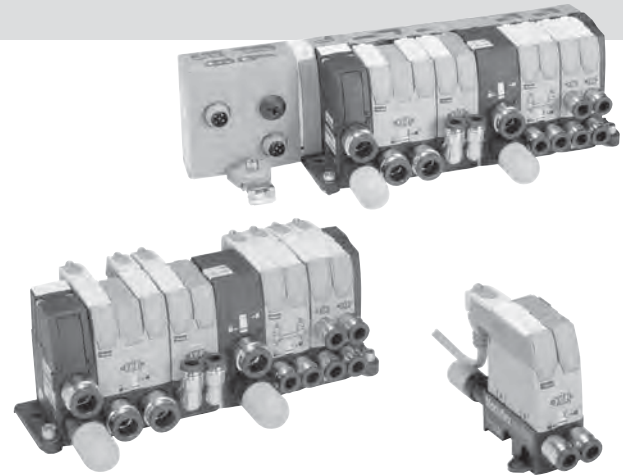

### Operating information

Operating pressure:	Vacuum to 123 PSIG (Vacuum to 8.3 bar)
Operating temperature:	5°F to 140°F (-15°C to 60°C)
Fieldbus operating temperature:	32°F to 130°F (0°C to 55°C)

## Dual 3/2 valves replace all 3-position valves for a better performance

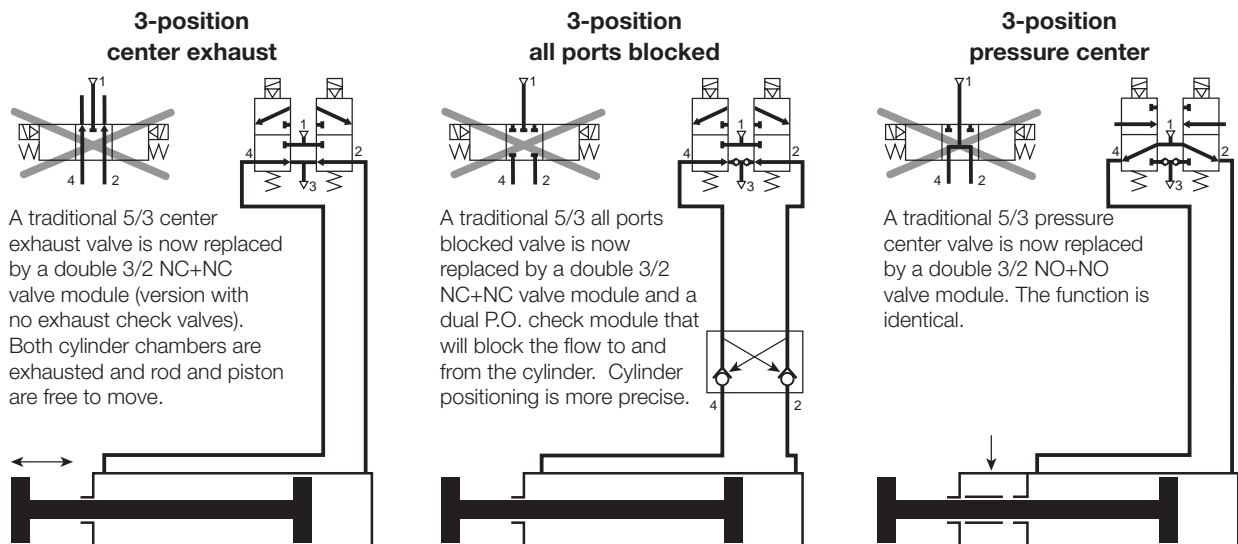

  Most popular.



Moduflex Series

Isys Micro Series

Isys ISO Series

Fieldbus













DX ISOMAX Series

Valvair II Series









**D**

Subbase & Manifold Valve Products











**“S” Series Individual Subbase Valves Size 1 (Valve & Base without Pneumatic Connectors)**

	Symbol	Type	Cv	Operator	Part number
Moduflex Series			4-way, 2-position	Single solenoid	<b>P2M1S4ES2C</b>
				Single air pilot	<b>P2M1S4PS</b>
			4-way, 2-position	Double solenoid	<b>P2M1S4EE2C</b>
				Double air pilot	<b>P2M1S4PP</b>
Isys Micro Series			3-way, 2-position, dual valve, NC/NC w/ exhaust check	Double solenoid	<b>P2M1SDEE2C</b>
				Double air pilot	<b>P2M1SDPP</b>
			3-way, 2-position, dual valve, NO/NO w/ exhaust check	Double solenoid	<b>P2M1SCEE2C</b>
				Double air pilot	<b>P2M1SCPP</b>
			3-way, 2-position, dual valve, NC/NO w/ exhaust check	Double solenoid	<b>P2M1SEEE2C</b>
				Single solenoid	<b>P2M1S3ES2C</b>
		3-way, 2-position, NC w/ exhaust check	Single air pilot	<b>P2M1S3PS</b>	
			Double solenoid	<b>P2M1SGEE2C</b>	
Isys ISO Series		3-way, 2-position, dual valve, NC/NC	0.22	Double solenoid	<b>P2M1SGEE2C</b>





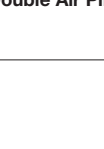

**“S” Series Size 1 Accessories**

	Description	Tube Size	Option	Part number	
DX ISOMAX Series		Size 1 push to connect fitting	5/32"	Elbow	<b>CMD04-1</b>
				Straight	<b>FMD04-1</b>
		Size 1 push to connect fitting	1/4"	Elbow	<b>CMD07-1B</b>
				Straight	<b>FMD07-1B</b>
Valvair II Series		Size 1 push to connect fitting	6mm	Elbow	<b>CMD06-1</b>
				Straight	<b>FMD06-1</b>
Subbase & Manifold Valve Products		Muffler for exhaust port		<b>MMDVA1</b>	
		Plug		<b>PMDYY1</b>	
		Double male union		Connecting peripheral modules	<b>HMDXX1</b>
		M8 female connector to flying lead - IP67 LED and surge protection		2m Cable	<b>P8LS08L226C</b>
				5m Cable	<b>P8LS08L526C</b>
				9m Cable	<b>P8LS08L926C</b>
		Field wireable connector		M8 Connector	<b>P8CS0803J</b>
				M12 Connector	<b>P8CS1204J</b>

**“S” Series Individual Subbase Valves Size 2 (Valve & Base without Pneumatic Connectors)**

	Symbol	Type	Cv	Operator	Part number
 <b>Single Solenoid</b>		4-way, 2-position	0.8	Single solenoid	<b>P2M2S4ES2C</b>
				Single air pilot	<b>P2M2S4PS</b>
 <b>Single Air Pilot</b>		4-way, 2-position	0.8	Double solenoid	<b>P2M2S4EE2C</b>
				Double air pilot	<b>P2M2S4PP</b>
 <b>Double Solenoid</b>		3-way, 2-position, dual valve, NC/NC w/ exhaust check	0.44	Double solenoid	<b>P2M2SDEE2C</b>
				Double air pilot	<b>P2M2SDPP</b>
 <b>Double Air Pilot</b>		3-way, 2-position, dual valve, NO/NO w/ exhaust check	0.44	Double solenoid	<b>P2M2SCEE2C</b>
				Double air pilot	<b>P2M2SCPP</b>
		3-way, 2-position, dual valve, NC/NO w/ exhaust check	0.44	Double solenoid	<b>P2M2SEEE2C</b>
		3-way, 2-position, NC w/ exhaust check	0.44	Single solenoid	<b>P2M2S3ES2C</b>
				Single air pilot	<b>P2M2S3PS</b>
		3-way, 2-position, dual valve, NC/NC	0.44	Double solenoid	<b>P2M2SGEE2C</b>

**“S” Series Size 2 Accessories**

	Description	Tube Size	Option	Part number
 	Size 2 push to connect fitting	1/4" OD tube	Elbow	<b>CMD07-2B</b>
			Straight	<b>FMD07-2B</b>
	Size 2 push to connect fitting	3/8" OD tube	Elbow	<b>CMD09-2B</b>
			Straight	<b>FMD09-2B</b>
	Size 2 push to connect fitting	1/2" OD tube	Straight	<b>FMD13-2B</b>
	Size 2 push to connect fitting	6mm OD tube	Elbow	<b>CMD06-2</b>
			Straight	<b>FMD06-2</b>
	Size 2 push to connect fitting	8mm OD tube	Elbow	<b>CMD08-2</b>
			Straight	<b>FMD08-2</b>
	Size 2 push to connect fitting	10mm OD tube	Elbow	<b>CMD10-2</b>
			Straight	<b>FMD10-2</b>
	Size 2 push to connect fitting	12mm OD tube	Elbow	<b>CMD12-2</b>
			Straight	<b>FMD12-2</b>
	Muffler for exhaust port			<b>MMDVA2</b>
	Plug			<b>PMDYY2</b>
	Double male union		Connecting peripheral modules	<b>HMDXX2</b>
	M8 female connector to flying lead - IP67 LED and surge protection		2m Cable	<b>P8LS08L226C</b>
			5m Cable	<b>P8LS08L526C</b>
			9m Cable	<b>P8LS08L926C</b>
	Field wireable connector		M8 Connector	<b>P8CS0803J</b>
			M12 Connector	<b>P8CS1204J</b>

Moduflex Series

Isys Micro Series

Isys ISO Series

Fieldbus

DX ISOMAX Series

Valvair II Series

**D**

Subbase & Manifold Valve Products

**“S” Series Individual Subbase Valve**  
*(Complete with Pneumatic and Electrical Connectors)*

- Moduflex Series
- Isys Micro Series
- Isys ISO Series
- Fieldbus
- DX ISOMAX Series
- Valvair II Series
- D** Subbase & Manifold Valve Products

**P2M 1 S 4ES 2C 00 A F4**

Basic series	
Moduflex	P2M

Size	
Size 1	1
Size 2	2

Valve series	
Individual subbase	S

Valve type / function	
<b>3-way / 2-position</b>	
Single solenoid, NC spring return	3ES
Single air pilot, NC spring return	3PS
<b>4-way / 2-position</b>	
Single solenoid, spring return	4ES
Single air pilot, spring return	4PS
Double solenoid	4EE
Double air pilot	4PP
<b>Dual 3-way, 2-position, spring return</b>	
Solenoid, NC / NC + PO check (4/3 APB)	BEE*
Air pilot, NC / NC + PO check (4/3 APB)	BPP*
Solenoid, NO / NO (4/3 Pressure Ctr.)	CEE
Air pilot NO / NO (4/3 Pressure Ctr.)	CPP
<b>Solenoid, NC / NC with exhaust check</b>	<b>DEE</b>
Air pilot, NC / NC with exhaust check	DPP
Solenoid, NO / NC with exhaust check	EEE
Solenoid, NC / NC without check (4/3 Exh. Ctr.)	GEE

Ports (all ports)	
C0*	10mm Elbow fitting
C2*	12mm Elbow fitting
<b>C4</b>	<b>5/32" (4mm) Elbow fitting</b>
C6	6mm Elbow fitting
<b>C7</b>	<b>1/4" Elbow fitting</b>
C8*	8mm Elbow fitting
<b>C9*</b>	<b>3/8" Elbow fitting</b>
F0*	10mm Straight fitting
F2*	12mm Straight fitting
<b>F3*</b>	<b>1/2" Straight fitting</b>
<b>F4</b>	<b>5/32" (4mm) Straight fitting</b>
F6	6mm Straight fitting
<b>F7</b>	<b>1/4" Straight fitting</b>
F8*	8mm Straight fitting
<b>F9*</b>	<b>3/8" Straight fitting</b>

\* Only available with size 2 valves.

Fitting configuration	
<b>A*</b>	<b>Straight fittings</b>
<b>B*</b>	<b>Elbow fittings</b>
<b>C*†</b>	<b>Straight fitting &amp; muffler</b>
<b>D*†</b>	<b>Elbow fitting &amp; muffler</b>

\* Ports 1 & 3 fittings sizes are same as ports 2 & 4 (see example at left.)

† Fitting in port 1, muffler in port 3.

LED / Cable	
<b>00</b>	<b>No cable, no LED, no surge suppression</b>
<b>V2</b>	<b>2 Meter cable with LED and surge suppression</b>
V5	5 Meter cable with LED and surge suppression
V9	9 Meter cable with LED and surge suppression

Operator voltage	
<b>24VDC</b>	<b>2C</b>
Remote pilot - 5/32" (4mm) Tube	00

Example for fitting configuration:  
**Size 1**

**CF7** Ports 1 & 3  
 1/4" straight fitting & muffler  
 Ports 2 & 4  
 1/4" straight fittings

**Size 2**

**AC0** Ports 1 & 3  
 10mm elbow fittings  
 Ports 2 & 4  
 10mm elbow fittings

\* Valve includes peripheral P. O. Check Valve and union fittings.







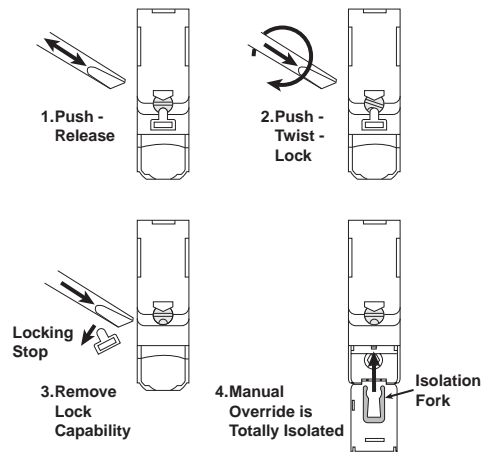









**With only one universal solenoid pilot for all configurations**

24VDC is now a global standard for all machines.  
 The Moduflex 24VDC unique solenoid pilot is supplied with the multi-function manual override that can be adapted to all requirements, as explained by the drawings.













**Multi-function adaptable manual override**



**"T" Series Manifold Valves with Individual Connectors Size 1**

	Symbol	Type	Cv	Operator	Part number
 <b>Single Solenoid</b>		4-way, 2-position	0.32	Single solenoid	<b>P2M1T4ES2C</b>
				Single air pilot	<b>P2M1T4PS</b>
 <b>Single Air Pilot</b>		4-way, 2-position	0.32	Double solenoid	<b>P2M1T4EE2C</b>
				Double air pilot	<b>P2M1T4PP</b>
 <b>Double Solenoid</b>		4-way, 2-position, dual valve w/ exhaust check	0.18	Double solenoid	<b>P2M1TJEE2C</b>
				Double air pilot	<b>P2M1TJPP</b>
 <b>Double Air Pilot</b>		3-way, 2-position, dual valve, NC/NC w/ exhaust check	0.22	Double solenoid	<b>P2M1TDEE2C</b>
				Double air pilot	<b>P2M1TDPP</b>
 <b>Double Solenoid</b>		3-way, 2-position, dual valve, NO/NO w/ exhaust check	0.22	Double solenoid	<b>P2M1TCEE2C</b>
				Double air pilot	<b>P2M1TCPP</b>
 <b>Double Air Pilot</b>		3-way, 2-position, dual valve, NC/NO w/ exhaust check	0.22	Double solenoid	<b>P2M1TEEE2C</b>
				Double air pilot	<b>P2M1T3ES2C</b>
 <b>Double Solenoid</b>		3-way, 2-position, NC w/ exhaust check	0.22	Single solenoid	<b>P2M1T3ES2C</b>
				Single air pilot	<b>P2M1T3PS</b>
 <b>Double Air Pilot</b>		3-way, 2-position, dual valve, NC/NC	0.22	Double solenoid	<b>P2M1TGEE2C</b>

**"T" Series Size 1 Accessories**

	Description	Tube size	Option	Part number
 	Size 1 push to connect fitting	5/32" or 4mm	Elbow	<b>CMD04-1</b>
			Straight	<b>FMD04-1</b>
 	Size 1 push to connect fitting	1/4"	Elbow	<b>CMD07-1B</b>
			Straight	<b>FMD07-1B</b>
 	Size 1 push to connect fitting	6mm	Elbow	<b>CMD06-1</b>
			Straight	<b>FMD06-1</b>
	Muffler for exhaust port			<b>MMDVA1</b>
	Plug			<b>PMDYY1</b>
	Double male union		Connecting peripheral modules	<b>HMDXX1</b>
	M8 female connector to flying lead - IP67 LED and surge protection		2M cable	<b>P8LS08L226C</b>
			5M cable	<b>P8LS08L526C</b>
			9M cable	<b>P8LS08L926C</b>
	Field wireable connector		M8 connector	<b>P8CS0803J</b>
			M12 connector	<b>P8CS1204J</b>
	Torx screwdriver			<b>P2M1K0TASD</b>

**Manifold Options**

Module	Part number
Pneumatic end plate kit	<b>P2M2HXT01*</b>
Pneumatic end plate kit with torx screwdriver	<b>P2M2HXT0T*</b>
Intermediate supply module (Includes 4 configuration plates)	<b>P2M2BXT0A*</b>

\* Use Fittings for Size 2 Modules Only













P2M2HXT01







P2M2BXT0A

**“T” Series Manifold Valves with Individual Connectors Size 2**

	Symbol	Type	Cv	Operator	Part number
 <p><b>Single Solenoid</b> <b>Single Air Pilot</b></p>		4-way, 2-position	0.8	Single solenoid	<b>P2M2T4ES2C</b>
				Single air pilot	<b>P2M2T4PS</b>
		4-way, 2-position	0.8	Double solenoid	<b>P2M2T4EE2C</b>
				Double air pilot	<b>P2M2T4PP</b>
 <p><b>Double Solenoid</b> <b>Double Air Pilot</b></p>		3-way, 2-position, dual valve, NC/NC w/ exhaust check	0.44	Double solenoid	<b>P2M2TDEE2C</b>
				Double air pilot	<b>P2M2TDPP</b>
		3-way, 2-position, dual valve, NO/NO w/ exhaust check	0.44	Double solenoid	<b>P2M2TCEE2C</b>
				Double air pilot	<b>P2M2TCPP</b>
 <p><b>Double Solenoid</b> <b>Double Air Pilot</b></p>		3-way, 2-position, dual valve, NC/NO w/ exhaust check	0.44	Double solenoid	<b>P2M2TEEE2C</b>
		3-way, 2-position, dual valve, NC w/ exhaust check	0.44	Single solenoid	<b>P2M2T3ES2C</b>
				Single air pilot	<b>P2M2T3PS</b>
		3-way, 2-position, dual valve, NC/NC	0.44	Double solenoid	<b>P2M2TGEE2C</b>

**“T” Series Size 2 Accessories**

	Description	Tube size	Option	Part number
 <p><b>Fieldbus</b></p>	Size 2 push to connect fitting	1/4"	Elbow	<b>CMD07-2B</b>
			Straight	<b>FMD07-2B</b>
	Size 2 push to connect fitting	3/8"	Elbow	<b>CMD09-2B</b>
			Straight	<b>FMD09-2B</b>
	Size 2 push to connect fitting	1/2"	Straight	<b>FMD13-2B</b>
 <p><b>DX ISOMAX</b></p>	Size 2 push to connect fitting	6mm	Elbow	<b>CMD06-2</b>
			Straight	<b>FMD06-2</b>
	Size 2 push to connect fitting	8mm	Elbow	<b>CMD08-2</b>
			Straight	<b>FMD08-2</b>
	Size 2 push to connect fitting	10mm	Elbow	<b>CMD10-2</b>
			Straight	<b>FMD10-2</b>
Size 2 Push to connect fitting	12mm	Elbow	<b>CMD12-2</b>	
		Straight	<b>FMD12-2</b>	
 <p><b>Valvar II</b></p>	Muffler for exhaust port			<b>MMDVA2</b>
	Plug			<b>PMDYY2</b>
	Double male union		Connecting peripheral modules	<b>HMDXX2</b>
	M8 female connector to flying lead - IP67 LED and surge protection		2M cable	<b>P8LS08L226C</b>
			5M cable	<b>P8LS08L526C</b>
			9M cable	<b>P8LS08L926C</b>
	Field wireable connector		M8 connector	<b>P8CS0803J</b>
			M12 connector	<b>P8CS1204J</b>
	Torx screwdriver			<b>P2M1K0TASD</b>

**Manifold Options**

Module	Part number
Pneumatic end plate kit	<b>P2M2HXT01*</b>
Pneumatic end plate kit with torx screwdriver	<b>P2M2HXT0T*</b>
Intermediate supply module (Includes 4 configuration plates)	<b>P2M2BXT0A*</b>

\* Use Fittings for Size 2 Modules Only



**“T” Series Valve Manifold with Individual Connectors**  
*(Complete with Pneumatic and Electrical Connectors)*

**P2M 1 T 4ES 2C 00 0 F4**

<b>Basic series</b>	
Valvetronic modules	P2M

<b>Size</b>	
Size 1	1
Size 2	2

<b>Valve series</b>	
Individual wire	T

Valve type / function	
<b>3-way / 2-position</b>	
Single solenoid, NC spring return	3ES
Single air pilot, NC spring return	3PS
<b>4-way / 2-position</b>	
Single solenoid, spring return	4ES
Single air pilot, spring return	4PS
Double solenoid	4EE
Double air pilot	4PP
<b>Dual 3-way, 2-position, spring return</b>	
Solenoid, NC / NC + PO check (4/3 APB)	BEE*
Air pilot, NC / NC + PO check (4/3 APB)	BPP*
Solenoid, NO / NO (4/3 Pressure Ctr.)	CEE
Air pilot NO / NO (4/3 Pressure Ctr.)	CPP
Solenoid, NC / NC with exhaust check	DEE
Air pilot, NC / NC with exhaust check	DPP
Solenoid, NO / NC with exhaust check	EEE
Solenoid, NC / NC without check (4/3 Exh. Ctr.)	GEE
<b>Dual 4-way, 2-position, Spring Return</b>	
Solenoid	JEE**
Air pilot	JPP**

Ports 2 & 4	
C0*	10mm Elbow fitting
C2*	12mm Elbow fitting
<b>C4</b>	<b>5/32" (4mm) Elbow fitting</b>
C6	6mm Elbow fitting
<b>C7</b>	<b>1/4" Elbow fitting</b>
C8*	8mm Elbow fitting
<b>C9*</b>	<b>3/8" Elbow fitting</b>
F0*	10mm Straight fitting
F2*	12mm Straight fitting
<b>F3*</b>	<b>1/2" Straight fitting</b>
<b>F4</b>	<b>5/32" (4mm) Straight fitting</b>
F6	6mm Straight fitting
<b>F7</b>	<b>1/4" Straight fitting</b>
F8*	8mm Straight fitting
<b>F9*</b>	<b>3/8" Straight fitting</b>

\* Only available with size 2 valves.

Ports 1 & 3	
0	None

Led / Cable	
00	No cable, no led, no surge suppression
V2	2 Meter cable with led and surge suppression
V5	5 Meter cable with led and surge suppression
V9	9 Meter cable with led and surge suppression

Operator Voltage	
2C	24VDC
00	Remote pilot - 5/32" (4mm) tube

**Moduflex Series**  
**Isys Micro Series**  
**Isys ISO Series**  
**Fieldbus**  
**DX ISOMAX Series**  
**Valvair II Series**  
**D**  
**Subbase & Manifold Valve Products**







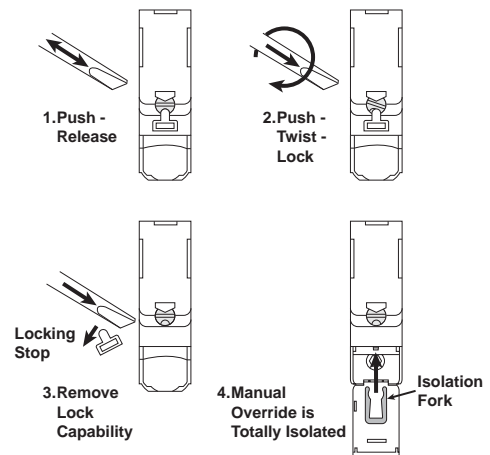

**With only one universal solenoid pilot for all configurations**

24VDC is now a global standard for all machines. The Moduflex 24VDC unique solenoid pilot is supplied with the multi-function manual override that can be adapted to all requirements, as explained by the drawings.





**Multi-function adaptable manual override**



**“V” Series Manifold Valves with Collective Wiring Size 1**

	Symbol	Type	Cv	Operator	Part number
 <p>Single Solenoid</p> <p>Double Solenoid</p>		4-way, 2-position	0.32	Single solenoid	<b>P2M1V4ES2CV</b>
		4-way, 2-position	0.32	Double solenoid	<b>P2M1V4EE2CV</b>
		4-way, 2-position, dual valve, w/ exhaust check	0.18		<b>P2M1VJEE2CV</b>
		3-way, 2-position, dual valve, NC/NC w/ exhaust check	0.22	Double solenoid	<b>P2M1VDEE2CV</b>
		3-way, 2-position, dual valve, NO/NO w/ exhaust check	0.22	Double solenoid	<b>P2M1VCEE2CV</b>
		3-way, 2-position, dual valve, NC/NO w/ exhaust check	0.22	Double solenoid	<b>P2M1VEEE2CV</b>
		3-way, 2-position, NC w/ exhaust check	0.22	Single solenoid	<b>P2M1V3ES2CV</b>
		3-way, 2-position, dual valve, NC/NC	0.22	Double solenoid	<b>P2M1VGEE2CV</b>

**“V” Series Size 1 Accessories**

	Description	Tube size	Option	Part number
	Size 1 push to connect fitting	5/32"	Elbow	<b>CMD04-1</b>
			Straight	<b>FMD04-1</b>
	Size 1 push to connect fitting	1/4"	Elbow	<b>CMD07-1B</b>
			Straight	<b>FMD07-1B</b>
	Size 1 push to connect fitting	6mm	Elbow	<b>CMD06-1</b>
			Straight	<b>FMD06-1</b>
	Muffler for exhaust port			<b>MMDVA1</b>
	Plug			<b>PMDYY1</b>
	Double male union		Connecting peripheral modules	<b>HMDXX1</b>
	Electrical 20-pin multi-connector cable with flying leads	IP65 rated	2M cable	<b>P8LMH20M2A</b>
			5M cable	<b>P8LMH20M5A</b>
			9M cable	<b>P8LMH20M9A</b>
	Electrical 25-pin D-sub cable	IP20 rated	3M cable	<b>P8LMH25M3A</b>
			9M cable	<b>SCD259D</b>
		IP65 rated	3M cable	<b>SCD253W</b>
			9M cable	<b>SCD259WE</b>
	Field wireable connector for power supply	Female	M12 - A code	<b>P8CS1205AA</b>
Line termination resistor	Profibus DP	M12 type B	<b>P8BPA00MB</b>	
	Devicenet or Canopen	M12 type A	<b>P8BPA00MA</b>	
AS-i M12 cable with jack for addressing		1M cable	<b>P8LS12JACK</b>	
	Torx screwdriver			<b>P2M1K0TASD</b>



### Electrical Connections

Description	Part number
20-pin, Multi-connector electrical head module	<b>P2M2HEV0A</b>
25-pin, D-sub, electrical head module	<b>P2M2HEV0D</b>

### Fieldbus Connections

Description	Part number	
Profibus DP	<b>P2M2HBVP21600</b>	
DeviceNet	<b>P2M2HBVD21600</b>	
CANopen	<b>P2M2HBVC21600</b>	
Interbus S	<b>P2M2HBVS11600</b>	
AS-i	0 inputs and 8 solenoid outputs	<b>P2M2HBVA10800</b>
AS-i	8 (PNP) inputs on eight (M8) connectors and 8 solenoid outputs	<b>P2M2HBVA10808A</b>
AS-i	8 (PNP) inputs on four (M12) connectors and 8 solenoid outputs	<b>P2M2HBVA10808B</b>
AS-i Version 2.1 Protocol	AS-i 0 inputs and 6 solenoid outputs	<b>P2M2HBVA20600</b>
AS-i Version 2.1 Protocol	AS-i 8 (PNP) inputs on eight (M8) connectors and 6 solenoid outputs	<b>P2M2HBVA20608A</b>
AS-i Version 2.1 Protocol	AS-i 8 (PNP) inputs on four (M12) connectors and 6 solenoid outputs	<b>P2M2HBVA20608B</b>

### Manifold Options

Module	Part number
Pneumatic end plate kit	<b>P2M2HXT01*</b>
Pneumatic end plate kit with torx screwdriver	<b>P2M2HXT0T*</b>
Intermediate supply module (Includes 4 configuration plates)	<b>P2M2BXV0A*</b>

\* Use Fittings for Size 2 Modules Only



P2M2HXT01



P2M2BXV0A

Moduflex Series

Isys Micro Series

Isys ISO Series

Fieldbus









DX ISOMAX Series

Valvair II Series







**D**

Subbase & Manifold Valve Products

**“V” Series Manifold Valves with Collective Wiring Size 2**

	Symbol	Type	Cv	Operator	Part number
 <p>Single Solenoid</p> <p>Double Solenoid</p>		4-way, 2-position	0.8	Single solenoid	<b>P2M2V4ES2CV</b>
		4-way, 2-position	0.8	Double solenoid	<b>P2M2V4EE2CV</b>
		3-way, 2-position, dual valve, NC/NC w/ exhaust check	0.44	Double solenoid	<b>P2M2VDEE2CV</b>
		3-way, 2-position, dual valve, NO/NO w/ exhaust check	0.44	Double solenoid	<b>P2M2VCEE2CV</b>
		3-way, 2-position, dual valve, NC/NO w/ exhaust check	0.44	Double solenoid	<b>P2M2VEEE2CV</b>
		3-way, 2-position, NC w/ exhaust check	0.44	Single solenoid	<b>P2M2V3ES2CV</b>
		3-way, 2-position, dual valve, NC/NC	0.44	Double solenoid	<b>P2M2VGEE2CV</b>

**“V” Series Size 2 Accessories**

	Description	Tube size	Option	Part number	
	Size 2 push to connect fitting	1/4" OD tube	Elbow	<b>CMD07-2B</b>	
			Straight	<b>FMD07-2B</b>	
	Size 2 push to connect fitting	3/8" OD tube	Elbow	<b>CMD09-2B</b>	
			Straight	<b>FMD09-2B</b>	
	Size 2 push to connect fitting	1/2" OD tube	Straight	<b>FMD13-2B</b>	
			Size 2 push to connect fitting	6mm OD tube	Elbow
	Straight	<b>FMD06-2</b>			
	Size 2 push to connect fitting	8mm OD tube	Elbow	<b>CMD08-2</b>	
			Straight	<b>FMD08-2</b>	
	Size 2 push to connect fitting	10mm OD tube	Elbow	<b>CMD10-2</b>	
			Straight	<b>FMD10-2</b>	
	Size 2 push to connect fitting	12mm OD tube	Elbow	<b>CMD12-2</b>	
Straight			<b>FMD12-2</b>		
	Muffler for exhaust port			<b>MMDVA2</b>	
	Plug			<b>PMDYY2</b>	
	Double Male Union		Connecting peripheral modules	<b>HMDXX2</b>	
	Electrical 20-pin multi-connector cable with flying leads	IP65 rated	2M cable	<b>P8LMH20M2A</b>	
			5M cable	<b>P8LMH20M5A</b>	
			9M cable	<b>P8LMH20M9A</b>	
	Electrical 25-pin D-sub cable	IP20 rated	3M cable	<b>P8LMH25M3A</b>	
			9M cable	<b>SCD259D</b>	
			IP65 rated	3M cable	<b>SCD253W</b>
				9M cable	<b>SCD259WE</b>
	Torx screwdriver			<b>P2M1K0TASD</b>	

### Electrical Connections

Description	Part number
20-pin, Multi-connector electrical head module	<b>P2M2HEV0A</b>
25-pin, D-sub, electrical head module	<b>P2M2HEV0D</b>

### Fieldbus Connections

Description	Part number	
Profibus DP	<b>P2M2HBVP21600</b>	
DeviceNet	<b>P2M2HBVD21600</b>	
CANopen	<b>P2M2HBVC21600</b>	
Interbus S	<b>P2M2HBVS11600</b>	
AS-i	0 inputs and 8 solenoid outputs	<b>P2M2HBVA10800</b>
AS-i	8 (PNP) inputs on eight (M8) connectors and 8 solenoid outputs	<b>P2M2HBVA10808A</b>
AS-i	8 (PNP) inputs on four (M12) connectors and 8 solenoid outputs	<b>P2M2HBVA10808B</b>
AS-i Version 2.1 Protocol AS-i	0 inputs and 6 solenoid outputs	<b>P2M2HBVA20600</b>
AS-i Version 2.1 Protocol AS-i	8 (PNP) inputs on eight (M8) connectors and 6 solenoid outputs	<b>P2M2HBVA20608A</b>
AS-i Version 2.1 Protocol AS-i	8 (PNP) inputs on four (M12) connectors and 6 solenoid outputs	<b>P2M2HBVA20608B</b>

### Manifold Options

Module	Part number
Pneumatic end plate kit	<b>P2M2HXT01*</b>
Pneumatic end plate kit with torx screwdriver	<b>P2M2HXT0T*</b>
Intermediate supply module (Includes 4 configuration plates)	<b>P2M2BXV0A*</b>

\* Use Fittings for Size 2 Modules Only



P2M2HXT01



P2M2BXV0A

Moduflex  
Series

Isys Micro  
Series

Isys ISO  
Series

Fieldbus

DX ISOMAX  
Series

Valvair II  
Series

**D**

Subbase & Manifold  
Valve Products

**“V” Series Valve Manifold with Collective Wiring**  
*(Complete with Pneumatic Connectors)*

Moduflex Series  
 Isys Micro Series  
 Isys ISO Series  
 Fieldbus  
 DX ISOMAX Series  
 Valvair II Series  
**D**  
 Subbase & Manifold Valve Products

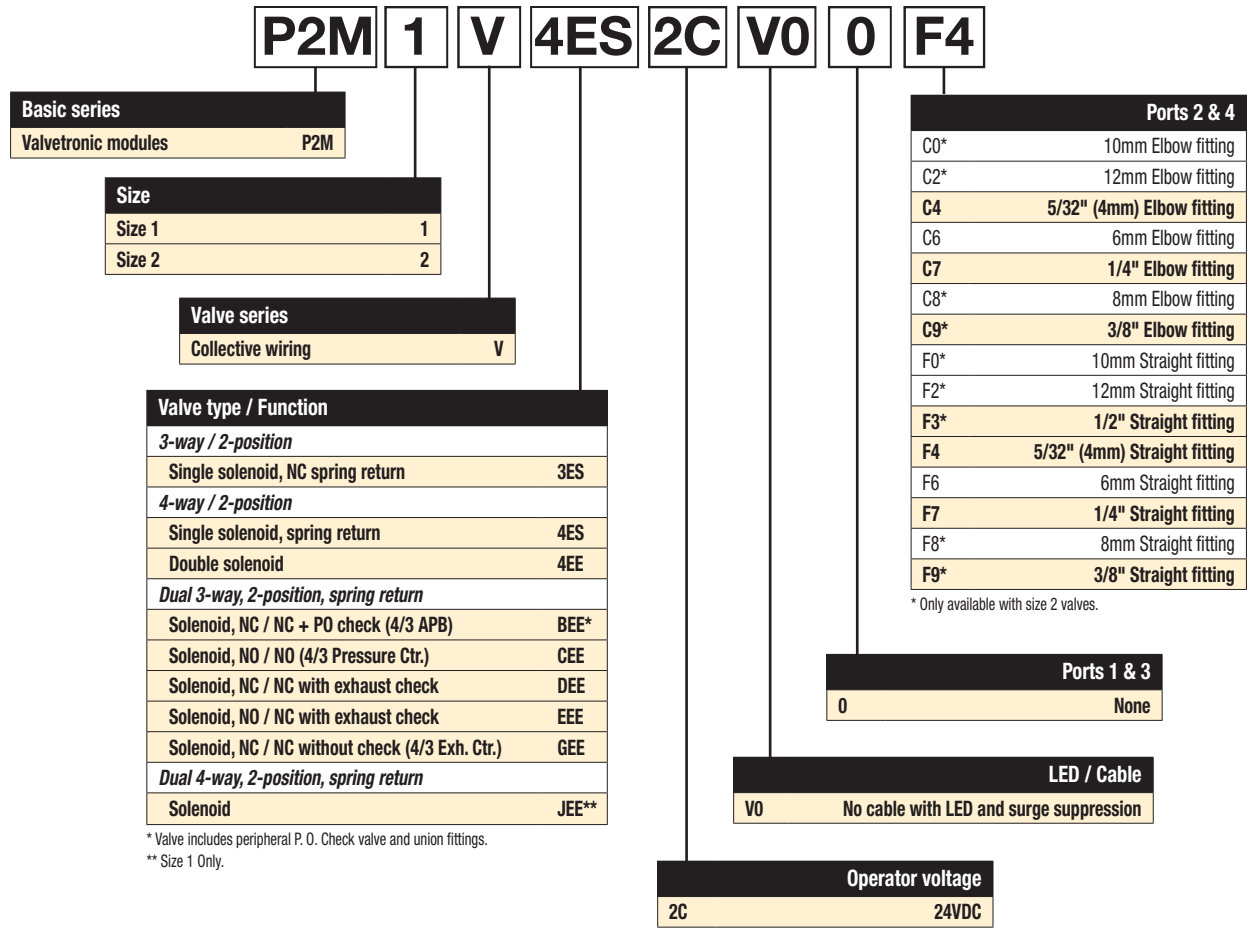







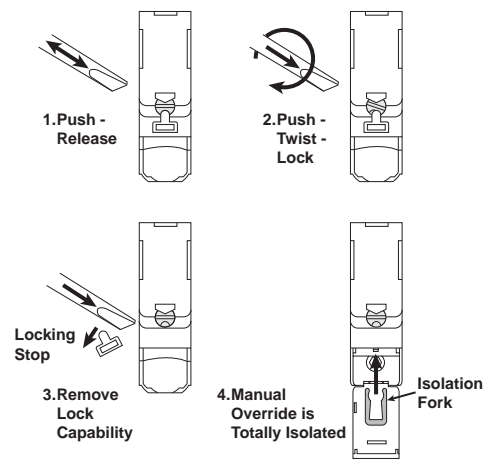



**With only one universal solenoid pilot for all configurations**

24VDC is now a global standard for all machines. The Moduflex 24VDC unique solenoid pilot is supplied with the multi-function manual override that can be adapted to all requirements, as explained by the drawings.

**Multi-function adaptable manual override**



**Peripheral Modules Size 1**

Accessories	Description	Option	Part number
	Pressure regulator without gauge	0 to 30 PSI	<b>P2M1PXST</b>
		0 to 60 PSI	<b>P2M1PXSL</b>
		0 to 120 PSI	<b>P2M1PXSX</b>
	Pressure regulator with gauge	0 to 30 PSI	<b>P2M1PXSR</b>
		0 to 60 PSI	<b>P2M1PXSM</b>
		0 to 120 PSI	<b>P2M1PXSG</b>
	Gauge	0 to 30 PSI	<b>P2M1K0GT</b>
		0 to 60 PSI	<b>P2M1K0GL</b>
		0 to 120 PSI	<b>P2M1K0GN</b>
	Dual P.O. Check valve		<b>P2M1PXCA</b>
	Dual flow control		<b>P2M1PXFA</b>
	Vacuum generator	See ordering information below	<b>P2M1PXVA</b>
	Size 1 push to connect fitting	5/32" or 4mm OD tube	Elbow <b>CMD04-1</b> Straight <b>FMD04-1</b>
		1/4" OD tube	Elbow <b>CMD07-1B</b> Straight <b>FMD07-1B</b>
	Size 1 push to connect fitting	6mm OD tube	Elbow <b>CMD06-1</b> Straight <b>FMD06-1</b>
			Connecting peripheral modules
	Double male union		<b>HMDXX1</b>
	Muffler for vacuum exhaust port		<b>MMDVA1</b>
	Plug		<b>PMDYY1</b>





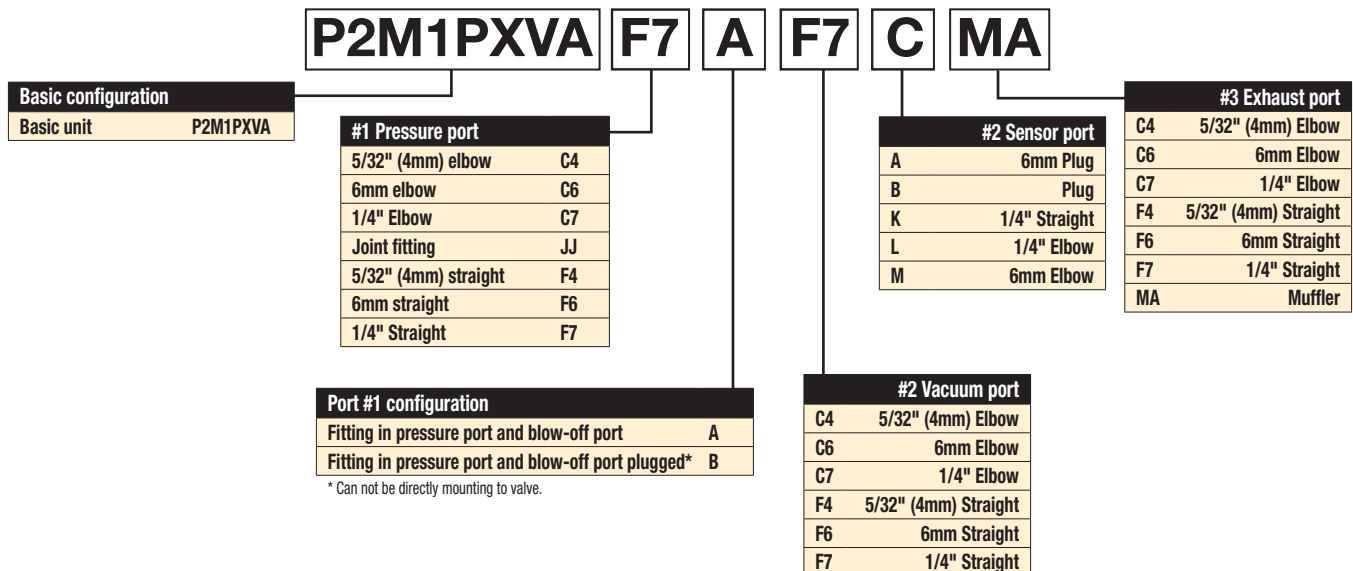



Moduflex Series  
 Isys Micro Series  
 Isys ISO Series  
 Fieldbus  
 DX ISOMAX Series  
 Valvair II Series

**Vacuum Generator Model Number Index**



**D**  
 Subbase & Manifold Valve Products

**Peripheral Modules Size 2**

	Acessories	Description	Option	Part number
Moduflex Series		Pressure regulator without gauge	0 to 30 PSI	<b>P2M2PXST</b>
			0 to 60 PSI	<b>P2M2PXSL</b>
			0 to 120 PSI	<b>P2M2PXSN</b>
Moduflex Series		Pressure regulator with gauge	0 to 30 PSI	<b>P2M2PXSR</b>
			0 to 60 PSI	<b>P2M2PXSM</b>
			0 to 120 PSI	<b>P2M2PXSG</b>
Isys Micro Series		Gauge	0 to 30 PSI	<b>P2M1K0GT</b>
			0 to 60 PSI	<b>P2M1K0GL</b>
			0 to 120 PSI	<b>P2M1K0GN</b>
Isys ISO Series		Dual P.O. check valve		<b>P2M2PXCA</b>
				Dual flow control
Fieldbus Series		Size 2 push to connect fitting	1/4" OD tube	Elbow <b>CMD07-2B</b>
			3/8" OD tube	Straight <b>FMD07-2B</b>
			1/2" OD tube	Elbow <b>CMD09-2B</b>
				Straight <b>FMD09-2B</b>
DX ISOMAX Series		Size 2 push to connect fitting	6mm OD tube	Elbow <b>CMD06-2</b>
			8mm OD tube	Straight <b>FMD06-2</b>
			10mm OD tube	Elbow <b>CMD08-2</b>
			12mm OD tube	Straight <b>FMD08-2</b>
				Elbow <b>CMD10-2</b>
				Straight <b>FMD10-2</b>
Valvar II Series		Size 2 push to connect fitting	12mm OD tube	Elbow <b>CMD12-2</b>
				Straight <b>FMD12-2</b>
Subbase & Manifold Valve Products		Muffler for exhaust port		<b>MMDVA2</b>
		Plug		<b>PMDYY2</b>
		Double Male Union	Connecting peripheral modules	<b>HMDXX2</b>

**“P” Series Peripheral Modules Model Number Index**  
*(Complete with Pneumatic Connectors)*

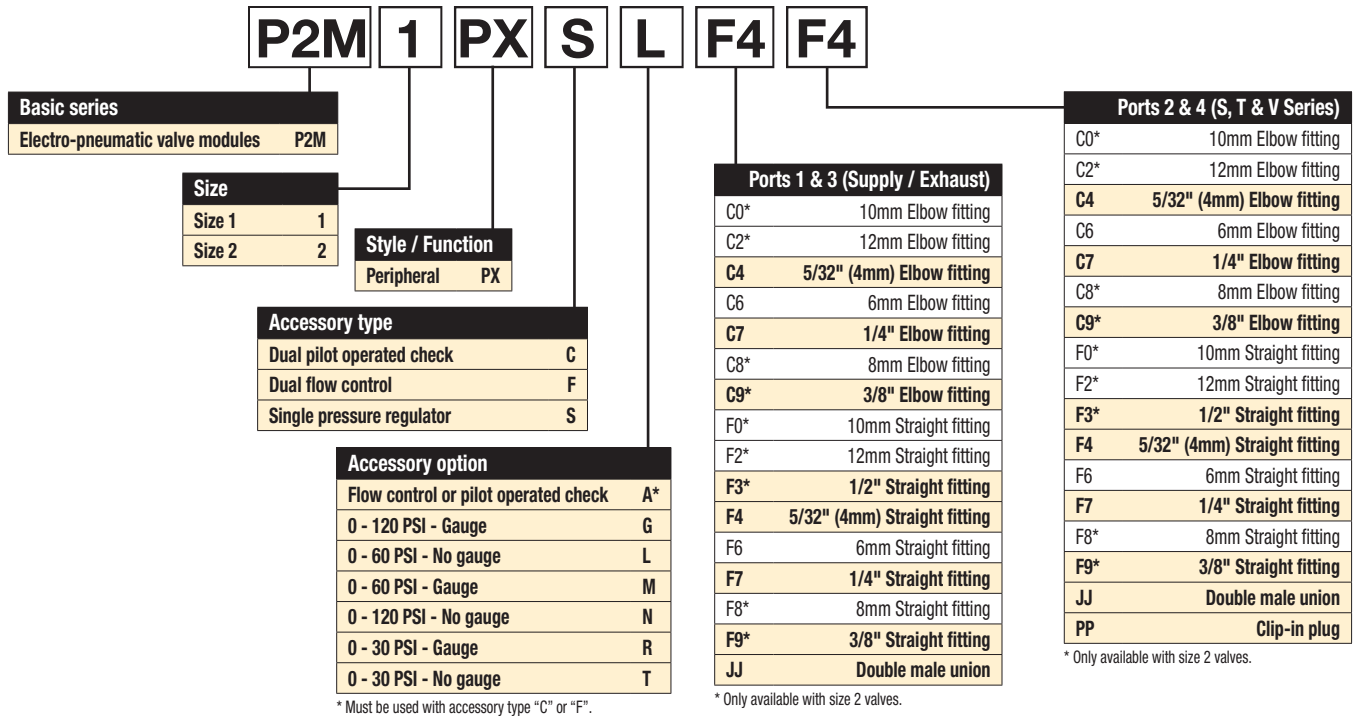

**Intermediate Supply Module Model Number Index**

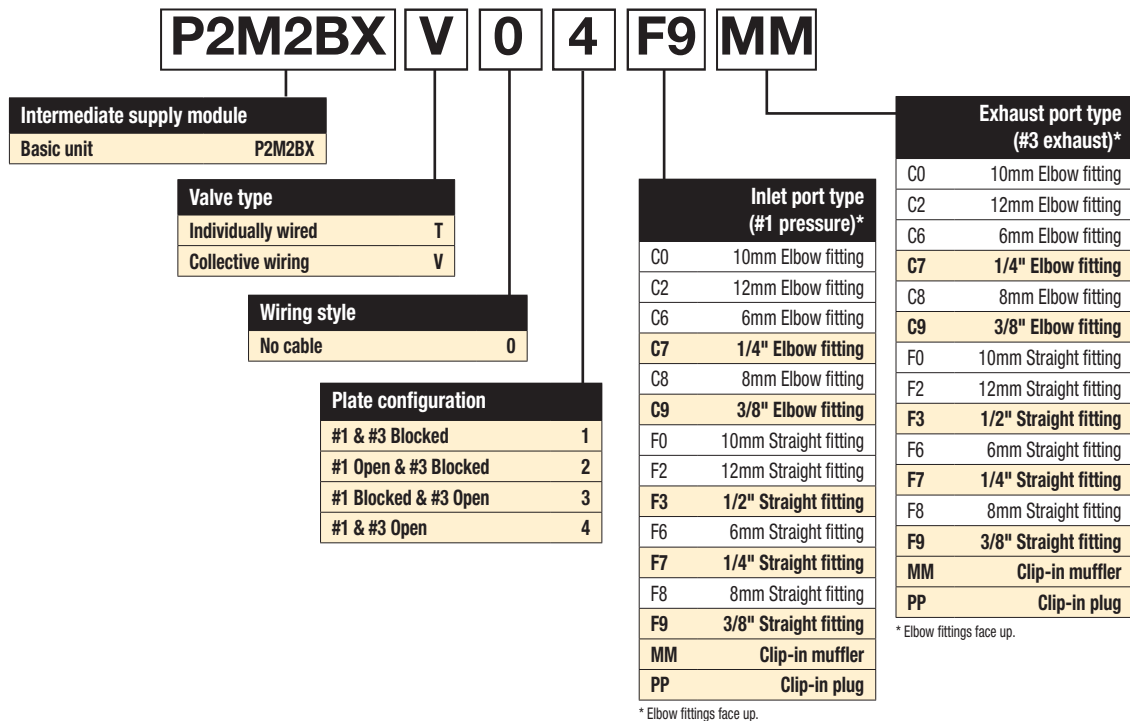

**Moduflex Add-A-Fold Assembly Model Number Index**  
 (Complete with Pneumatic and Electrical Connectors)

**How To Order Plug-in Add-A-Fold Assemblies**

1. List Add-A-Fold Assembly call out. This automatically includes the end plate kit assembly.
2. List valves and manifolds. List left to right, LOOKING AT THE CYLINDER PORTS on the manifold.

**P2MA V 0 1 C9 C9 ##**

Moduflex island assembly	
Add-A-Fold	P2MA*

\*Includes pneumatic H & T end plate kit.

Style	
Individually wired	T
Collective wiring	V*

\* Includes 20-pin multi-connector or 25-pin, D-sub electrical head module.

Wiring / Bus protocol	
No cable (20-pin or multi-connector T series)	0
2 Meter cable (20-pin)	2
5 Meter cable (20-pin)	5
9 Meter cable (20-pin)	9
Bus	
No cable (25-pin, D-sub)	D
3 Meter cable (25-pin, D-sub)	F

\* Order bus module as a separate line item.  
 † Default to option "0" for T series.

Pilot source	
Internal supply / Internal exhaust	1
Internal supply / External exhaust	2
External supply / Internal exhaust	3
External supply / External exhaust	4

Number of stations <sup>†</sup>	
01 - 19*	V-Type
01 - 30	T-Type

\* Max. number of addresses for V type is 19. Single solenoid valves equal one address. Double solenoid valves equal two addresses. Maximum address may depend upon choice of bus protocol.

† Intermediate modules are considered stations, but do not count against maximum number of addresses for manifold.

Exhaust port type (#3 Exhaust)*	
C0	10mm Elbow fitting
C2	12mm Elbow fitting
C6	6mm Elbow fitting
<b>C7</b>	<b>1/4" Elbow fitting</b>
C8	8mm Elbow fitting
<b>C9</b>	<b>3/8" Elbow fitting</b>
F0	10mm Straight fitting
F2	12mm Straight fitting
<b>F3</b>	<b>1/2" Straight fitting</b>
F6	6mm Straight fitting
<b>F7</b>	<b>1/4" Straight fitting</b>
F8	8mm Straight fitting
<b>F9</b>	<b>3/8" Straight fitting</b>
MM	Clip-in muffler
PP	Clip-in plug

\* Elbow fittings face up.

Inlet port type (#1 pressure)*	
C0	10mm Elbow fitting
C2	12mm Elbow fitting
C6	6mm Elbow fitting
<b>C7</b>	<b>1/4" Elbow fitting</b>
C8	8mm Elbow fitting
<b>C9</b>	<b>3/8" Elbow fitting</b>
F0	10mm Straight fitting
F2	12mm Straight fitting
<b>F3</b>	<b>1/2" Straight fitting</b>
F6	6mm Straight fitting
<b>F7</b>	<b>1/4" Straight fitting</b>
F8	8mm Straight fitting
<b>F9</b>	<b>3/8" Straight fitting</b>
MM	Clip-in muffler
PP	Clip-in plug

\* Elbow fittings face up.

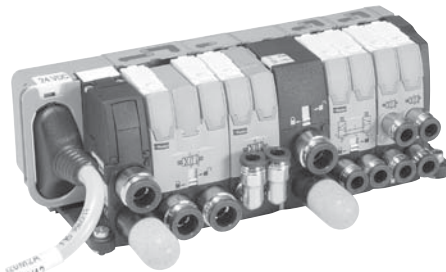

"V" Series with 20-pin Connector



"V" Series with Field Bus Connection

Moduflex Series  
 Isys Micro Series  
 Isys ISO Series  
 Fieldbus  
 DX ISOMAX Series  
 Valvair II Series  
**D**  
 Subbase & Manifold Valve Products



**Internal and external pilot supply options**

All T and V Series Valve bases incorporate an auxiliary channel "X" to supply pressure to the solenoid pilots. The "X" galley is pressurized from the left hand end plate. Depending on the configuration of the left hand end plate, this pressure is either supplied from the #1 port in the left hand end plate or supplied externally through a 4mm OD tube fitting in the left hand end plate. This fitting is supplied in all left hand end plates and can be converted in the field.

**Internal and external solenoid pilot exhaust options**

All T and V Series Valve bases incorporate an auxiliary channel "E" which is used to exhaust the solenoid pilot pressure from each solenoid valve. The "E" galley is connected to the left hand end plate. Depending on the configuration of the left hand end plate, this exhaust is either connected to the #3 exhaust port or is connected to a 4mm OD Tube fitting in the left hand end plate. This fitting is supplied in all left hand end plates and can be converted in the field.

To configure the left hand end plate, with pressure off, remove head cover to expose the selector section. Loosen selector section and rotate "X" or "E" channel selector to desired position. Tighten selector section and assemble cover.

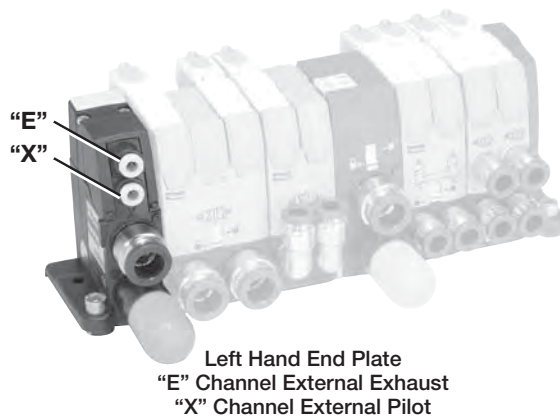
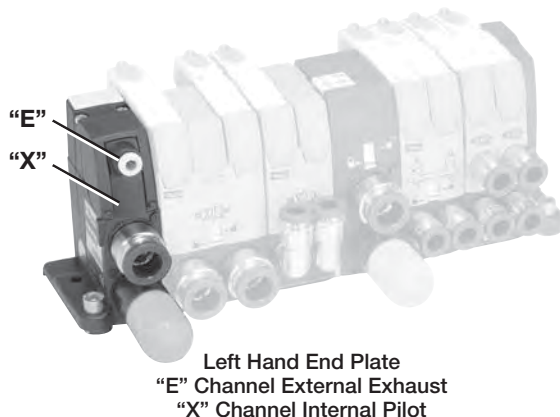
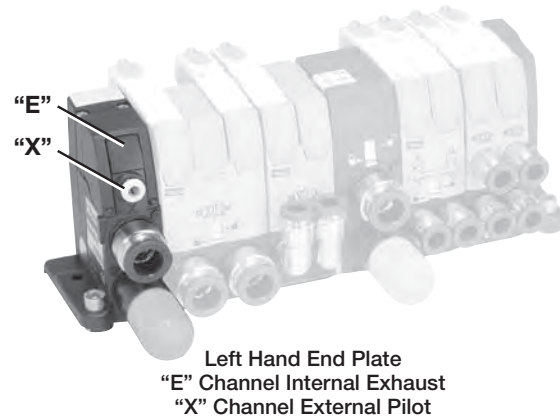
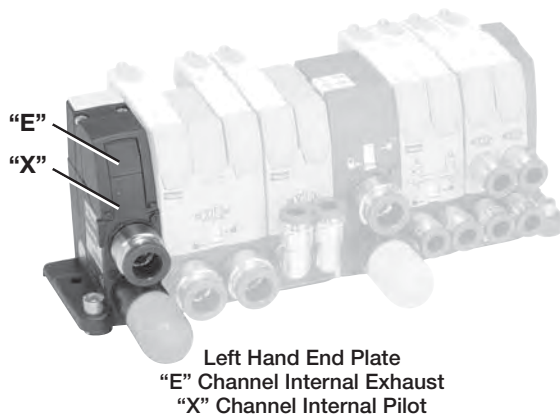
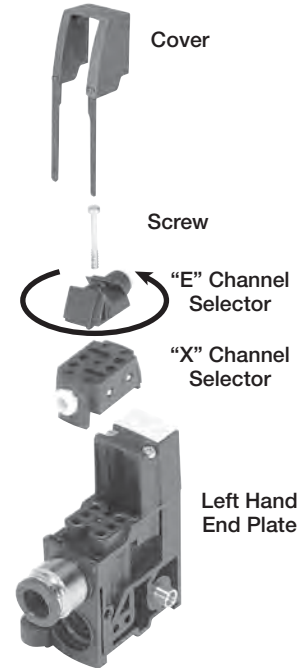

Moduflex Series
Isys Micro Series
Isys ISO Series
Fieldbus
DX ISOMAX Series
Valvair II Series
<b>D</b>
Subbase & Manifold Valve Products

**Solenoid Pilot 24VDC**

Description	Part number
Solenoid pilot (without plug-in electrical connector)	<b>P2D8V32C5</b>
Air pilot with 5/32" (4mm) tube fitting	<b>P2M2K0PA</b>



P2D8V32C5



P2M2K0PA

Moduflex Series

Isys Micro Series

**Size 1 Valve Without Solenoid Pilot and Without Subbase**



P2M1X4EE

**4-way / 2-position / Single Valve**

Solenoid	Part number
Single solenoid (Monostable)	<b>P2M1X4ES</b>
Double solenoid (Bistable)	<b>P2M1X4EE</b>

**4-way / 2-position / Dual Valve**

Solenoid	Part number
Solenoid spring with exhaust check	<b>P2M1XJEE</b>

**3-way / 2-position / Dual Valve**

Solenoid	Part number
Double solenoid NC + NC with exhaust check	<b>P2M1XDDE</b>
Double solenoid NO + NO with exhaust check	<b>P2M1XCEE</b>
Double solenoid NC + NO with exhaust check	<b>P2M1XEEE</b>
Single solenoid NC with exhaust check	<b>P2M1X3ES</b>

**Size 2 Valve Without Solenoid Pilot and Without Subbase**



P2M2X4EE

**4-way / 2-position / Dual Valve**

Solenoid	Part number
Single solenoid (Monostable)	<b>P2M2X4ES</b>
Double solenoid (Bistable)	<b>P2M2X4EE</b>

**3-way / 2-position / Dual Valve**

Solenoid	Part number
Double solenoid NC + NC with exhaust check	<b>P2M2XDEE</b>
Double solenoid NO + NO with exhaust check	<b>P2M2XCEE</b>
Double solenoid NC + NO with exhaust check	<b>P2M2XEEE</b>
Single solenoid NC with exhaust check	<b>P2M2X3ES</b>

Isys ISO Series

Fieldbus

DX ISOMAX Series

Valvair II Series

**D**

Subbase & Manifold Valve Products

**Set of Maintenance Parts**

Description	Part number
Clips Set of 10 clips: 6 for size 1 valves, 2 for size 2 valves, 2 for end plate and intermediate modules	<b>P2M2K0CA</b>
Seals Set of 10 seals: 3 for manifold to manifold seals, 3 under solenoid pilot seals, 4 under valve seals (two size 1 seals, two size 2 seals)	<b>P2M2K0JA</b>
Forks Set of 10 isolation forks for solenoid pilot manual override	<b>P2M2K0FA</b>

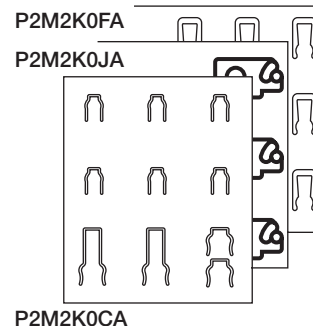

**“S” Series Individual Subbase Valve Dimensions and Mounting**

**Subbase Valve Size 1**



**Subbase Valve Size 2**



Surface Mounting with Screws 4 mm Dia. into Retractable Brackets 3mm Thick

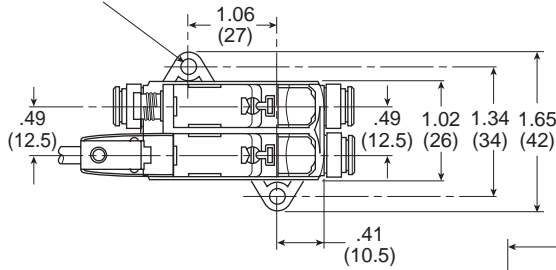

Surface Mounting with Screws 4 mm Dia. into Retractable Brackets 3mm Thick

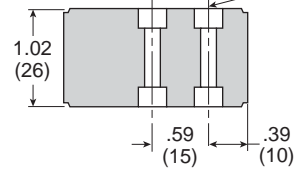
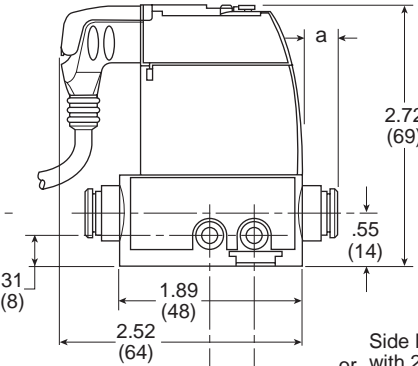
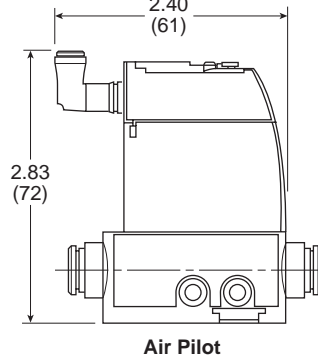
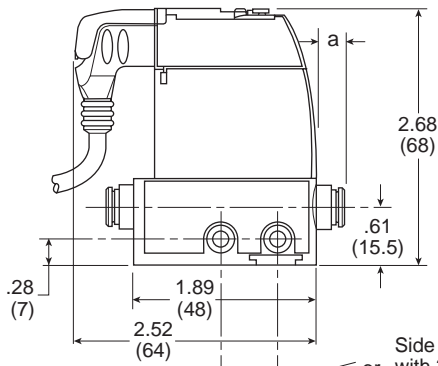
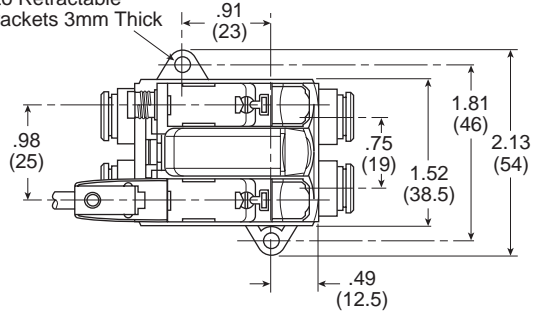

Side Mounting with 2 Screws 4mm Dia.

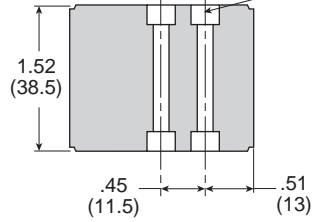

Side Mounting with 2 Screws 4mm Dia.

**Size 1**

**Size 2**

	OD Tube Ext.	a	b	c
<b>Size 1 Valves</b>	5/32" (4 mm)	8	10	12
	6 mm	8	13	16
	1/4"	15	18	22
	Muffler		31	
<b>Size 2 Valves</b>	1/4"	12	18	22
	8 mm	9	16	19
	3/8"	16	23	26
	10 mm	13	18	22
	Muffler		40	

**Special Case:** 4/3 all ports blocked. Add the dual P.O. check valve that has been plugged in the basic valve.

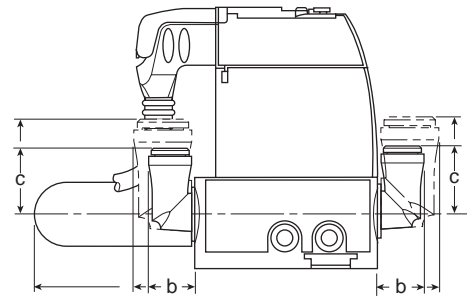

Moduflex Series

Isys Micro Series

Isys ISO Series

Fieldbus

DX ISOMAX Series

Valvair II Series

**D**

Subbase & Manifold Valve Products

**"T" Series Manifold Dimensions and Mounting**

- Moduflex Series
- Isys Micro Series
- Isys ISO Series
- Fieldbus
- DX ISOMAX Series
- Valvair II Series
- D** Subbase & Manifold Valve Products



Total Width Depends on Valve Composition

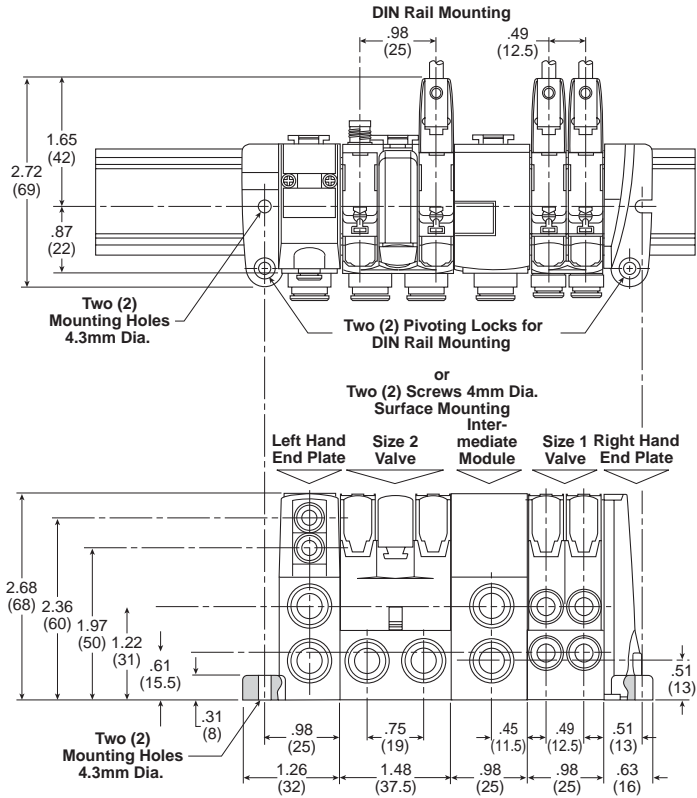
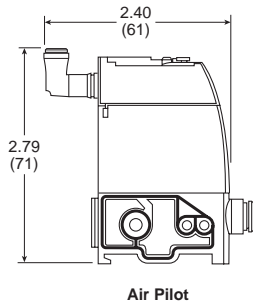
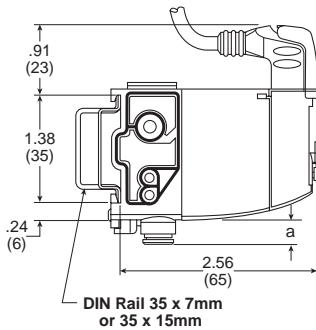

**Special Case:** 4/3 all ports blocked function within island version, add the dimensions of the dual P.O. check valve plugged into the island.

**End Plate and Intermediate Modules**

	a	b	c
6 mm Tube OD	8	13	16
1/4" Tube OD	12	18	22
8 mm Tube OD	9	16	19
3/8" Tube OD	16	23	26
10 mm Tube OD	13	18	25
12 mm Tube OD	13	19	25
1/2" Tube OD	13		
Muffler	40		

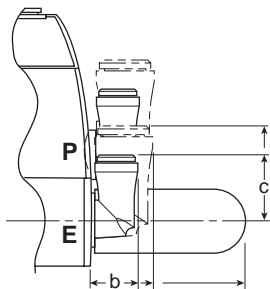

OD Tube	Ext.	a	b	c
Size 1 Valves	5/32" (4 mm)	8	10	12
	6 mm	8	13	16
	1/4"	15	18	22
Size 2 Valves	1/4"	12	18	22
	8 mm	9	16	19
	3/8"	16	23	26
	10 mm	13	18	22

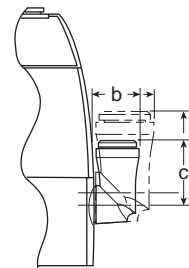

**“V” Series Manifold Dimensions and Mounting**  
 20-pin, Multi-Connector Valve Manifold

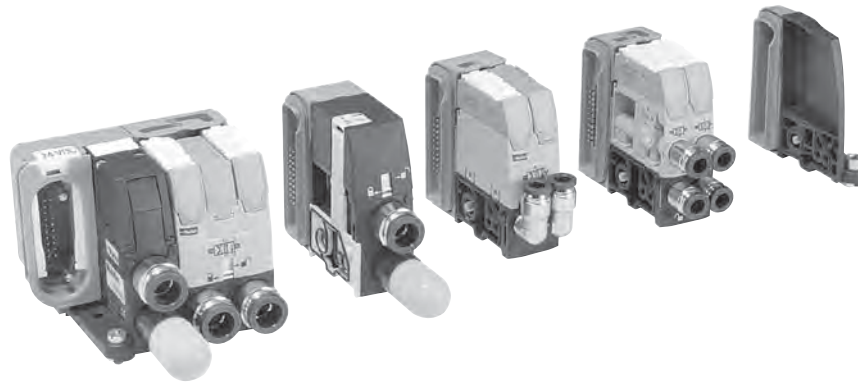

Total Width Depends  
 on Valve Composition

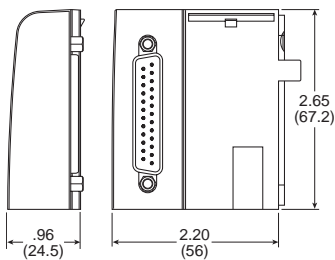
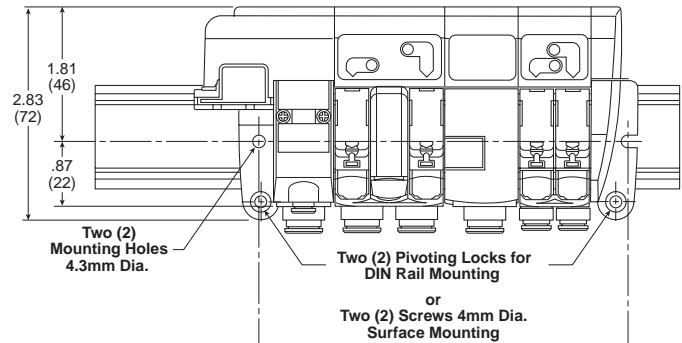
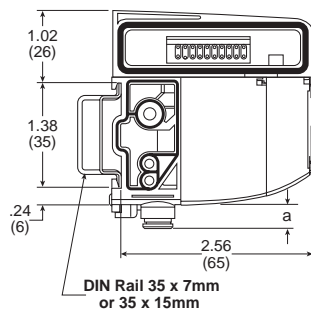

25-pin,  
 D-Sub

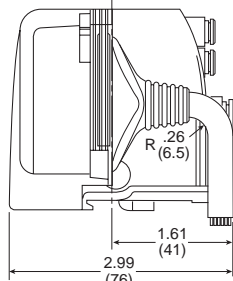

20-pin,  
 Multi-Connector

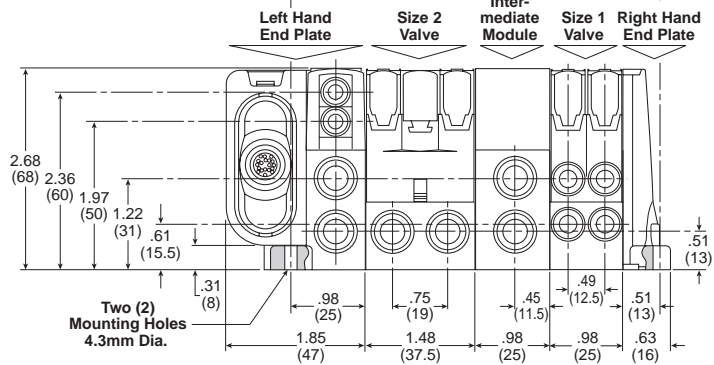

**End Plate and  
 Intermediate Modules**

	a	b	c
6 mm Tube OD	8	13	16
1/4" Tube OD	12	18	22
8 mm Tube OD	9	16	19
3/8" Tube OD	16	23	26
10 mm Tube OD	13	18	25
12 mm Tube OD	13	19	25
1/2" Tube OD	13		
Muffler	40		

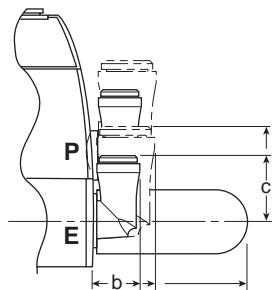

OD Tube	Ext.	a	b	c
Size 1 Modules	5/32" (4 mm)	8	10	12
	6 mm	8	13	16
	1/4"	15	18	22
Size 2 Modules	1/4"	12	18	22
	8 mm	9	16	19
	3/8"	16	23	26
	10 mm	13	18	22

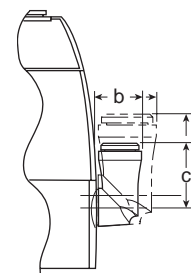

Moduflex  
 Series

Isys Micro  
 Series

Isys ISO  
 Series

Fieldbus

DX ISOMAX  
 Series

Valvair II  
 Series

**D**

Subbase & Manifold  
 Valve Products

**“V” Series Manifold Dimensions and Mounting**  
 Fieldbus Connected Manifolds

Total Width Depends  
 on Valve Composition



**AS-i Bus Islands**

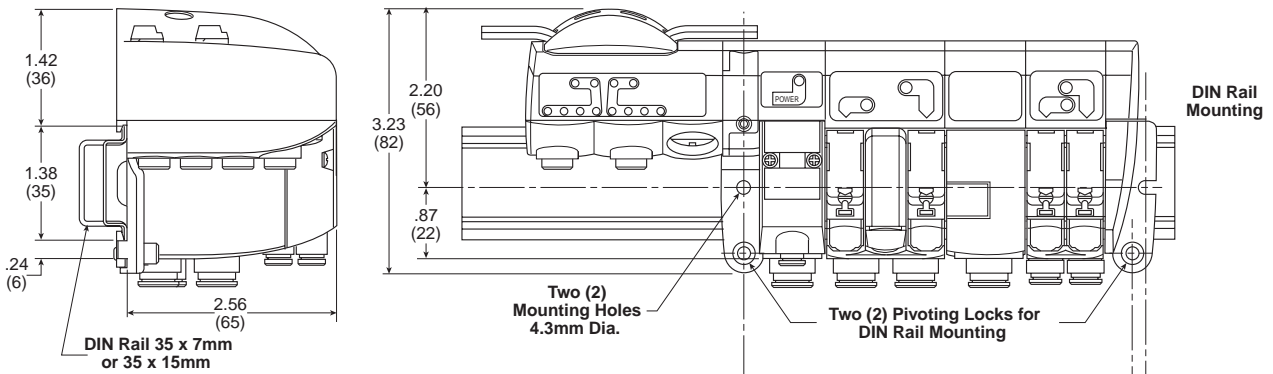

**Device Bus Islands**

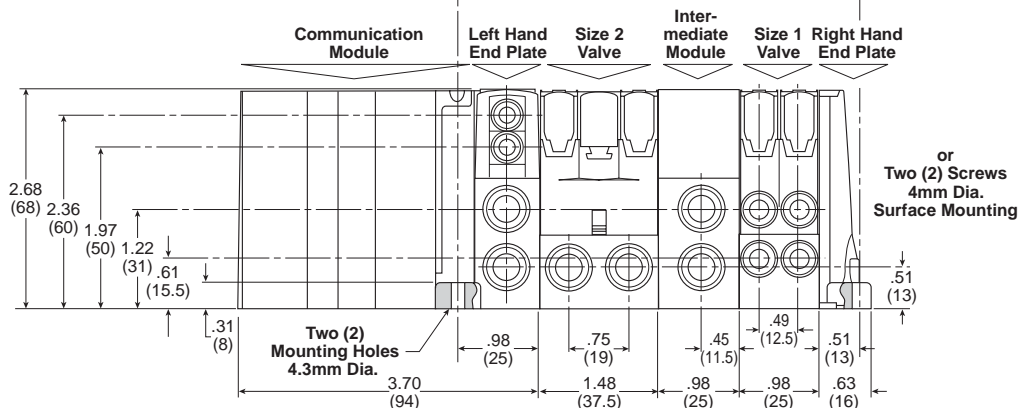
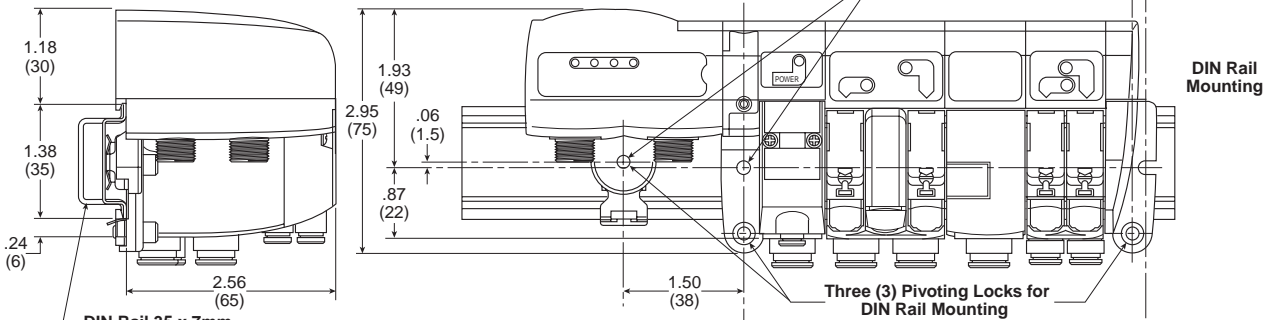

Moduflex Series
Isys Micro Series
Isys ISO Series
Fieldbus
DX ISOMAX Series
Valvair II Series
<b>D</b>
Subbase & Manifold Valve Products



**“P” Series Peripheral Modules Dimensions and Mounting**

**Reminder:** Peripheral modules may either be plugged in the valve output ports or mounted in-line separate from the valve.

**Peripheral Module Plugged in a Valve**

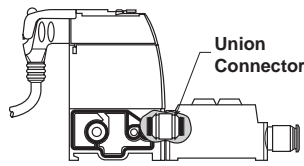

**In-Line Peripheral Modules: Mounting is Required**

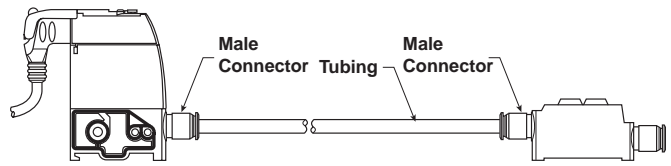

**Dual Flow Control Size 1**

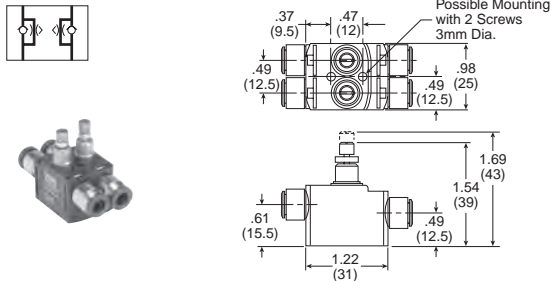

**Dual Flow Control Size 2**

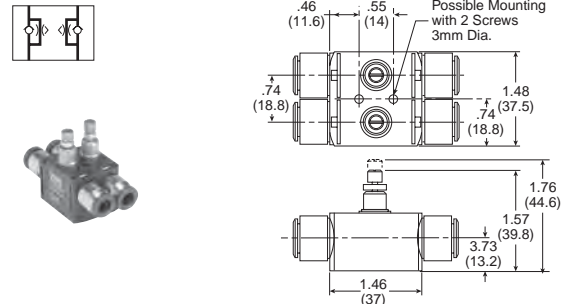

**Pressure Regulator Size 1**

**With Gauge**

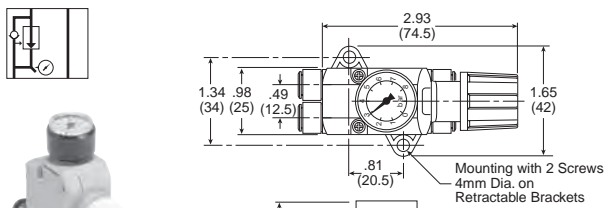

**Without Gauge**

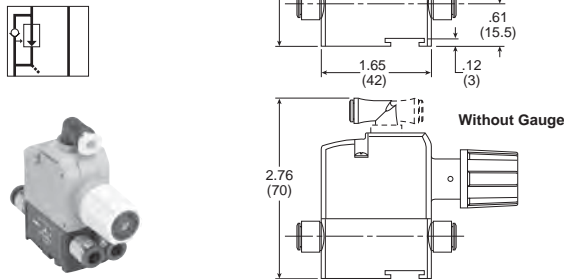

**Pressure Regulator Size 2**

**With Gauge**

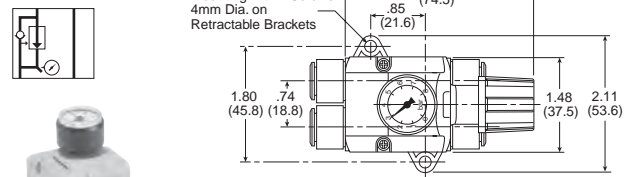

**Without Gauge**

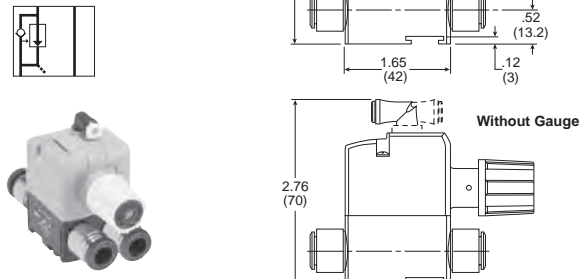

**Dual P.O. Check Valve Size 1**

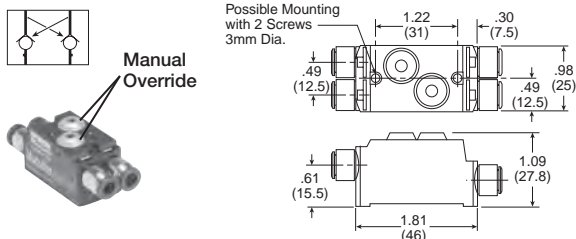

**Dual P.O. Check Valve Size 2**

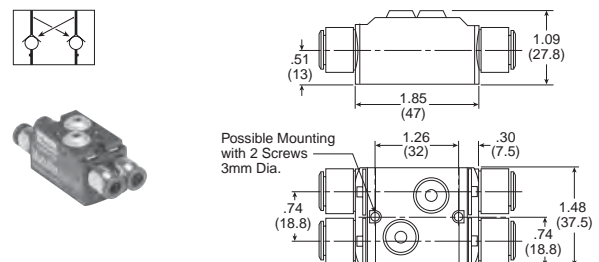

Moduflex Series

Isys Micro Series

Isys ISO Series

Fieldbus

DX ISOMAX Series

Valvair II Series

**D**

Subbase & Manifold Valve Products

**“P” Series Peripheral Modules Dimensions and Mounting**

**Reminder:** Peripheral modules may either be plugged in the valve output ports or mounted in-line separate from the valve.

**Vacuum Generator Size 1**

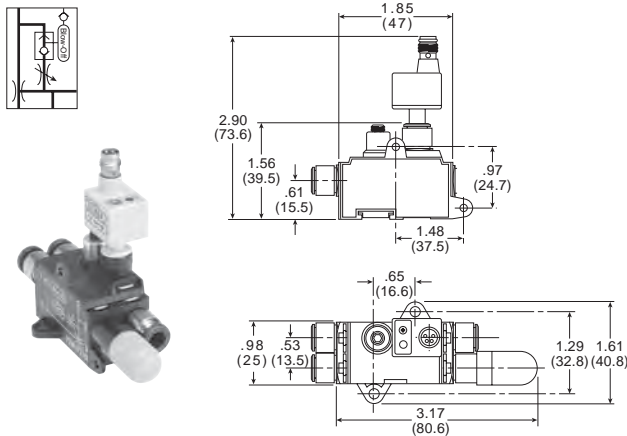

**Sensor specifications**

Fieldbus	Media	Air and non-corrosives gases
	Proof pressure	(V) 72.5 PSI
	Operating temperature	32 to 122°F (0 to 50°C)
DX ISOMAX Series	Storage temperature	14 to 140°F (-10 to 60°C)
	Humidity	35 to 85% RH
	Electrical connection	(C) 4-pin, M8 connector
Valvar II Series	Power supply	10.8 to 30 VDC, ripple Vp-p 10% max., reverse voltage protection
	Switch output	1 output signal open and closed, NPN or PNP, 30VDC, 125mA
	Linear output	Analog output 1 to 5 VDC
	Switch point setting	2/3 turn trimmer
	Hysteresis setting	< 2% of F.S.
	Output response time	<1ms
	Repeatability	<0.2% F.S.
D Subbase & Manifold Valve Products	Shock resistance	100 G, XYZ
	Material	Housing: Polycarbonate, pressure port: Zinc die-cast
	Mass	T Port: 0.25 oz. (7g)

**Sensor pin out**

- Pin #
- 1 Brown: 24VDC
  - 2 White: NPN / PNP open collector output
  - 3 Blue: 0VDC
  - 4 Black: NPN / PNP open collector output

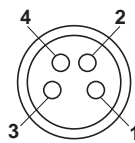

**Cables**

**CB-M8-4P-2M, Female to Open Lead**

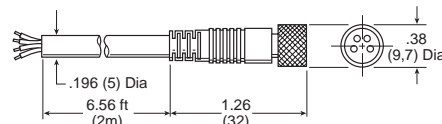

**CB-M8-4P-5M, Female to Open Lead**

