

## Type 8905

### Cleaning system

Cleaning system for the online analysis system  
Reinigungssystem zum Online-Analyse-System  
Système de nettoyage pour le système d'analyse en ligne

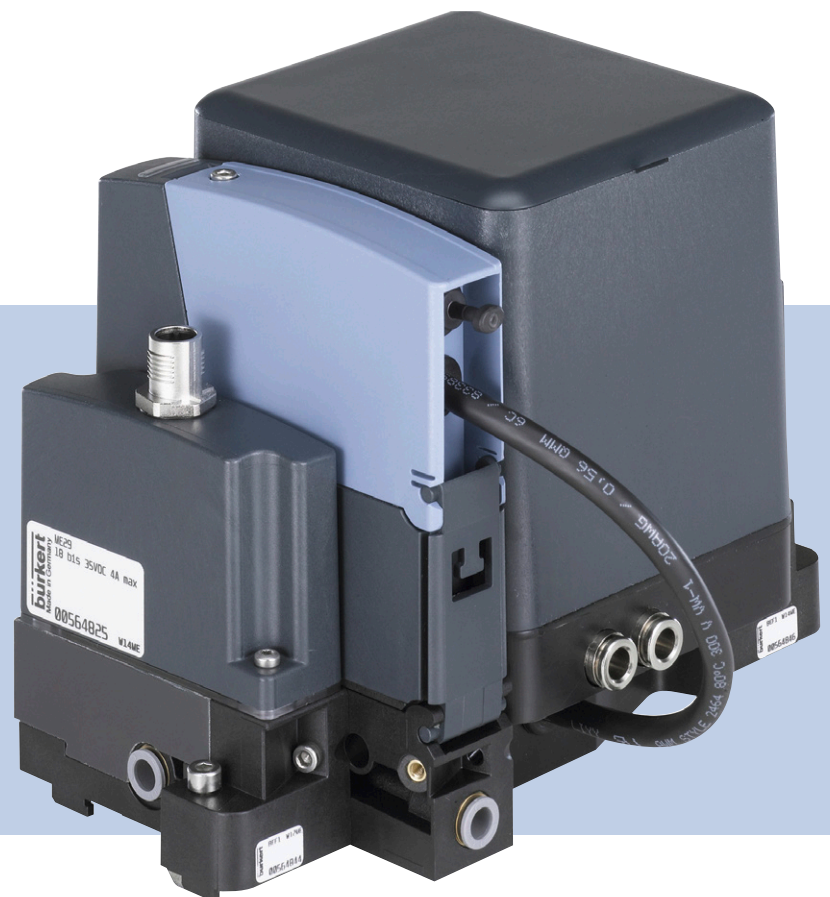

Operating Instructions

Bedienungsanleitung  
Manuel d'utilisation

We reserve the right to make technical changes without notice.  
Technische Änderungen vorbehalten.  
Sous réserve de modifications techniques.

© Bürkert Werke GmbH, 2015

Operating Instructions 1511/01\_EU-ML\_00810488 / Original DE

## Cleaning system Type 8905

<b>1</b>	<b>THE OPERATING INSTRUCTIONS</b> .....	<b>5</b>
	1.1 Symbols .....	5
	1.2 Definition of the term "device" .....	5
<b>2</b>	<b>AUTHORIZED USE</b> .....	<b>6</b>
	2.1 Restrictions .....	6
<b>3</b>	<b>BASIC SAFETY INSTRUCTIONS</b> .....	<b>7</b>
<b>4</b>	<b>GENERAL INFORMATION</b> .....	<b>8</b>
	4.1 Contact address .....	8
	4.2 Warranty .....	8
	4.3 Information on the Internet .....	8
<b>5</b>	<b>DESCRIPTION OF THE DEVICE</b> .....	<b>9</b>
	5.1 Intended application area .....	9
	5.2 Structure of the cleaning system .....	9
<b>6</b>	<b>TECHNICAL DATA</b> .....	<b>10</b>
	6.1 Conformity .....	10
	6.2 Standards .....	10
	6.3 Technical data .....	10
	6.4 Rating plate .....	10
<b>7</b>	<b>ASSEMBLY</b> .....	<b>11</b>
	7.1 Installation location .....	11
	7.2 Fluid connection .....	12
	7.2.1 Measuring water supply line .....	12
	7.2.2 Measuring water discharge .....	13
	7.2.3 Connection of the cleaning solution .....	13
	7.3 Electrical connection .....	14
	7.3.1 Operating voltage .....	14
	7.3.2 Connection device communication .....	15

MAN 1000268359 EN Version: B Status: RL (released | freigegeben) printed: 22.09.2017

<b>8</b>	<b>START-UP .....</b>	<b>16</b>
<b>9</b>	<b>OPERATION ON THE MEASURING SYSTEM WITH DISPLAY .....</b>	<b>17</b>
	<b>9.1 Parameterizing the büS function .....</b>	<b>18</b>
	<b>9.2 Parameterizing the cleaning system function .....</b>	<b>18</b>
	<b>9.3 Parameterizing the time switch function .....</b>	<b>20</b>
	<b>9.4 Parameterizing the Digital output 4 function .....</b>	<b>23</b>
<b>10</b>	<b>OPERATION OF THE CLEANING SYSTEM .....</b>	<b>24</b>
	<b>10.1 Recommended cleaning to remove iron deposits and limescale .....</b>	<b>24</b>
	<b>10.2 Recommended cleaning for organic soiling .....</b>	<b>26</b>
<b>11</b>	<b>MAINTENANCE .....</b>	<b>27</b>
	<b>11.1 Changing container cleaning solution .....</b>	<b>27</b>
	<b>11.2 Warning and error messages .....</b>	<b>28</b>
	11.2.1 Warning messages cleaning system .....	29
	11.2.2 Error messages cleaning system .....	29
<b>12</b>	<b>ACCESSORIES .....</b>	<b>30</b>
<b>13</b>	<b>DISASSEMBLY .....</b>	<b>31</b>
<b>14</b>	<b>TRANSPORTATION, STORAGE, DISPOSAL .....</b>	<b>31</b>

# 1 THE OPERATING INSTRUCTIONS

The operating instructions describe the entire life cycle of the device. Keep these instructions in a location which is easily accessible to every user and make these instructions available to every new owner of the device.

## Important safety information.

Read these instructions carefully and thoroughly. Study in particular the chapters entitled *Intended use* and *Basic safety instructions*.

- ▶ The operating instructions must be read and understood.

## 1.1 Symbols

### **DANGER!**

Warns of an immediate danger.

- ▶ Failure to observe the warning will result in fatal or serious injuries.

### **WARNING!**

Warns of a potentially dangerous situation.

- ▶ Failure to observe the warning may result in serious injuries or death.

### **CAUTION!**

Warns of a possible danger.

- ▶ Failure to observe this warning may result in a moderate or minor injury.

### **NOTE!**

Warns of damage to property.

- ▶ Failure to observe the warning may result in damage to the device or other equipment.

 indicates important additional information, tips and recommendations.

 refers to information in these operating instructions or in other documentation.

▶ designates instructions for risk prevention.

→ designates a procedure which you must carry out.

## 1.2 Definition of the term "device"

In these instructions, the term "device" always refers to the cleaning system Type 8905.

In these instructions, the term "measuring system" always refers to the online analysis system Type 8905.

## 2 AUTHORIZED USE

**Non-authorized use of the device may be dangerous to people, nearby equipment and the environment.**

**The device is designed as an auxiliary cleaning module for the online analysis system Type 8905 and its sensors and may be used for that purpose only.**

- ▶ Use only cleaning solutions approved and specified by Bürkert.
- ▶ Use according to the authorized data, operating conditions, and conditions of use specified in the contract documents and operating instructions.
- ▶ Use the device indoors only.
- ▶ Install the device in an area which is protected from frost.
- ▶ Protect the device from electromagnetic interference.
- ▶ Use the device only in conjunction with third-party devices and components recommended and authorized by Bürkert.
- ▶ Correct transportation, storage, and installation, as well as careful operation and maintenance are essential for reliable and faultless operation of the device.
- ▶ Use the device for its intended purpose only.

### 2.1 Restrictions

If exporting the device, observe any existing restrictions.

### 3 BASIC SAFETY INSTRUCTIONS

These safety instructions do not make allowance for any

- contingencies and events which may arise during the assembly, operation, and maintenance.
- local safety regulations – the operator is responsible for observing these regulations, also in relation to the installation personnel.



#### Risk of electric shock.

- If a 21.6...26.4 V DC version is installed in a damp environment, all electrical voltages may be max. 26.4 V DC.
- Before starting work, switch off all power supplies connected to the device and secure to prevent unintentional reactivation.
- Observe applicable accident prevention and safety regulations for electrical equipment.

#### Danger – high pressure in the equipment.

- Before detaching the process connections, depressurize the equipment and stop the liquid circulation.

#### Danger due to cleaning solution.

- When working with cleaning solutions, follow the instructions on the safety data sheet provided.
- When working with cleaning solutions, wear personal protective equipment.

#### General hazardous situations.

To prevent injuries:

- Do not use the device in the potentially explosive area.
- Do not make any internal or external changes on the device and do not subject it to mechanical stress.
- Secure the device from unintentional actuation.
- After an interruption in the power supply, ensure that the process is restarted in a controlled manner.
- Only trained technicians may perform installation and maintenance work.
- Install the device according to the regulations applicable in the country.
- Observe the general rules of technology.

#### NOTE!

##### Electrostatic sensitive components / modules.

The device contains electronic components which react sensitively to electrostatic discharge (ESD). Contact with electrostatically charged persons or objects are hazardous to these components. In the worst case scenario, they will be destroyed immediately or will fail after start-up.

- Observe the requirements in accordance with EN 61340-5-1 to minimize or avoid the possibility of damage caused by a sudden electrostatic discharge.
- Do not touch electronic components while the supply voltage is switched on.

## 4 GENERAL INFORMATION

### 4.1 Contact address

#### Germany

Bürkert Fluid Control Systems  
Sales Center  
Christian-Bürkert-Str. 13-17  
D-74653 Ingelfingen  
Tel. + 49 (0) 7940 - 10 91 111  
Fax + 49 (0) 7940 - 10 91 448  
Email: [info@de.buerkert.com](mailto:info@de.buerkert.com)

#### International

Contact addresses can be found on the final pages of the printed operating instructions.

And also on the Internet at: [www.burkert.com](http://www.burkert.com)

### 4.2 Warranty

The warranty is only valid if the device is used as intended in accordance with the specified application conditions.

### 4.3 Information on the Internet

The operating instructions and data sheets for the device can be found on the Internet at: [www.burkert.com](http://www.burkert.com)



## 5 DESCRIPTION OF THE DEVICE

### 5.1 Intended application area

The device is designed as an auxiliary cleaning module for the online analysis system Type 8905 and its sensors. The quality of the measuring water may soil the sensors of the measuring system. Examples of soiling are limescale, iron deposits or growth of algae.

To ensure continuously good measurements, clean the sensors at equal intervals irrespective of the quality of the measuring water. Use only cleaning solutions approved and specified by Bürkert: acidic, alkaline and neutral solutions.

Cleaning can be done manually using the cleaning accessories (see operating instructions for the sensors) or a büS-compatible cleaning system.

The cleaning system is connected as an auxiliary module upstream of the measuring system and doses liquid cleaning solutions into the measuring system. All relevant functions, such as switching off the measuring water, dosing the solution and signaling the status via büS, are run by the cleaning system. Cleaning is therefore run fully automatically. Details on cleaning see chapter "10" on page 24

### 5.2 Structure of the cleaning system

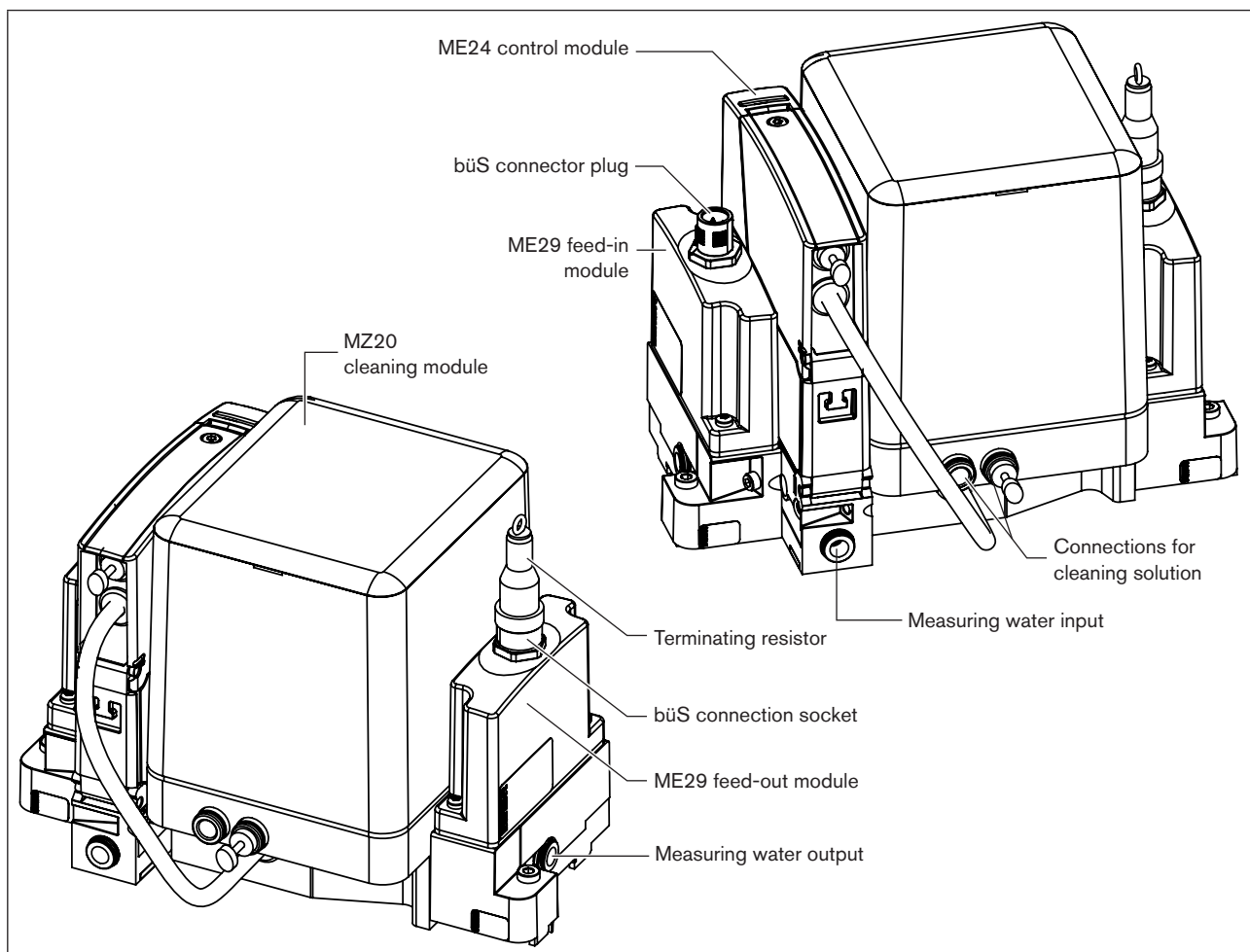

Figure 1: Cleaning system Type 8905: Structure

## 6 TECHNICAL DATA

### 6.1 Conformity

The device conforms to the EC directives according to the EC Declaration of Conformity (if applicable).

### 6.2 Standards

The applied standards which are used to demonstrate compliance with the EC Directives are listed in the EC Prototype Examination Certificate and/or the EC Declaration of Conformity (where applicable).

### 6.3 Technical data

The technical data can be found in the specifications on the data sheet. These can be found on the Internet at: [www.burkert.com](http://www.burkert.com).

### 6.4 Rating plate



The following values are indicated on the rating plate:

Power supply voltage	24 V ± 10 %
Power consumption	14 W
IP degree of protection	IP65
Nominal pressure	6 bar
Ambient/medium temperature	0/3...40 °C
Serial number	S/N

## 7 ASSEMBLY



### CAUTION!

#### Risk of electric shock.

- ▶ If a 21.6...26.4 V DC version is installed in a damp environment, all electrical voltages may be max. 26.4 V DC.
- ▶ Before starting work, switch off all power supplies connected to the device and secure to prevent unintentional reactivation.
- ▶ Observe applicable accident prevention and safety regulations for electrical equipment.

#### Danger – high pressure in the equipment.

- ▶ Before detaching the process connections, depressurize the equipment and stop the liquid circulation.

#### Danger due to cleaning solution.

- ▶ When working with cleaning solutions, follow the instructions on the safety data sheet provided.
- ▶ When working with cleaning solutions, wear personal protective equipment.

### 7.1 Installation location

#### NOTE!

#### Damage to the device caused by the environment.

- ▶ Use the device indoors only.
- ▶ Install the device in an area which is protected from frost.
- ▶ Protect the device from electromagnetic interference.

The cleaning system is suitable for mounting on the wall using a standard rail (TS 35). The standard rail must be attached horizontally to a flat wall which is suitable for the installation.

- Weight of device  $m = 1.2 \text{ kg}$
- Torque for attachment  $M_{\text{max}} = 1 \text{ Nm}$

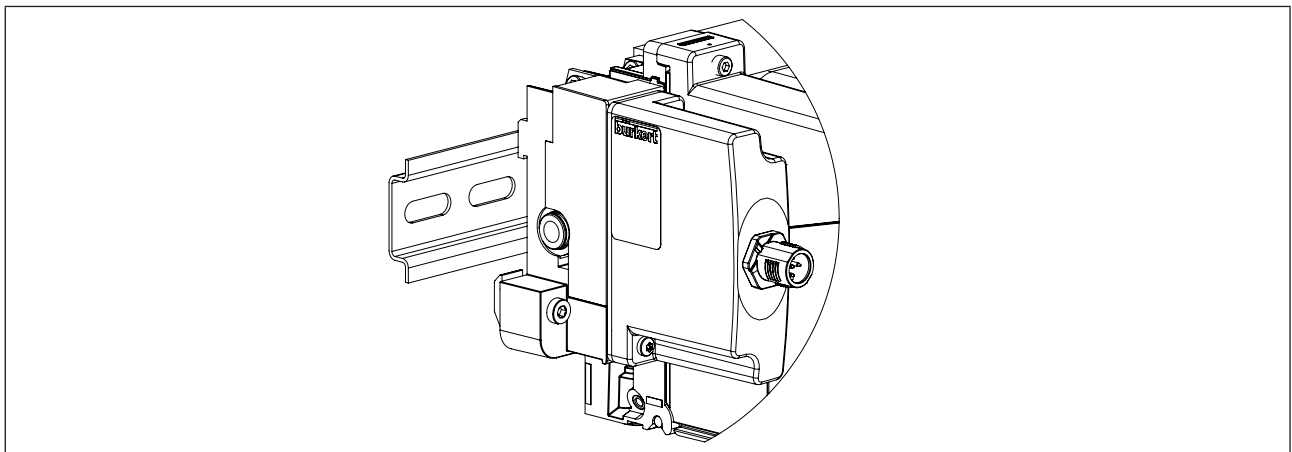

Figure 2: Cleaning system Type 8905: Wall mounting using a standard rail TS 35

## 7.2 Fluid connection

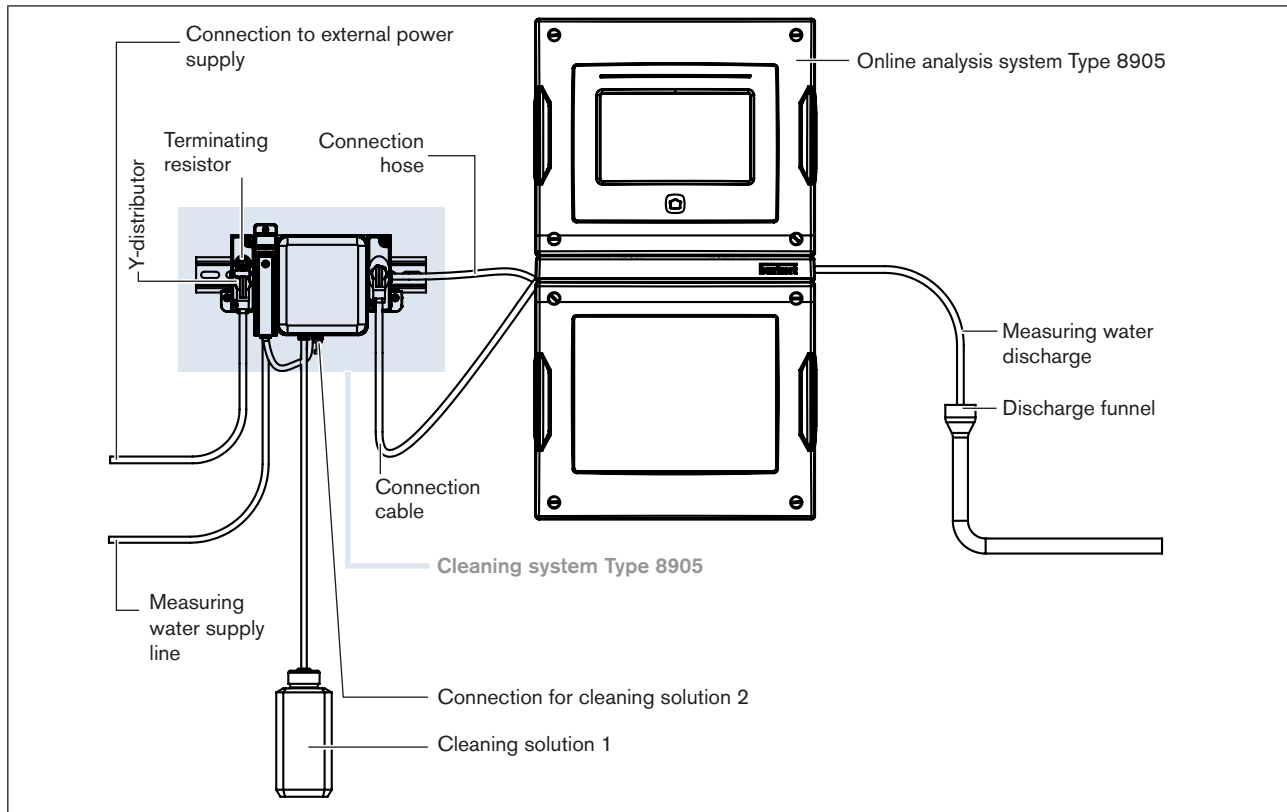

Figure 3: Cleaning system Type 8905: Fluid connection

### 7.2.1 Measuring water supply line

#### NOTE!

To prevent water or cleaning solution from flowing back into the supply network, backflow inhibitors or system separators are required (these may be subject to regulatory requirements or local regulations).

The cleaning system is connected between the measuring water supply and the measuring system to be cleaned.

The connection is made via hoses (6 mm) and the plug-in hose connections integrated in the cleaning and measuring system.



To minimize pump times and use cleaning solution sparingly, the hose length between the cleaning system and measuring system or its individual sensors must be as short as possible.

The hose length must not exceed 2 m.

## 7.2.2 Measuring water discharge

As there may be cleaning solution in the waste water, it is recommended to discard all the water. If the water cannot be discarded, only the liquid from the cleaning cycle can be discarded via a separation valve. The valve is controlled via a digital output on the cleaning system; the digital output can be parameterized via a measuring system with display or via the Bürkert communications software Communicator (description see chapter "9.4" on page 23).

The waste water from the measuring system must be discharged without pressure via a funnel and a waste water pipe. The waste water can be discharged without pressure, e.g. into a gully.



The waste water outlet must always be positioned higher than the container of cleaning solution. This prevents the container of cleaning solution from emptying when the waste water is discharged.

## 7.2.3 Connection of the cleaning solution



### CAUTION!

**Danger due to cleaning solution.**

- ▶ When working with cleaning solutions, follow the instructions on the safety data sheet provided.
- ▶ When working with cleaning solutions, wear personal protective equipment.

The connection is made via hoses (6 mm) and the plug-in hose connections integrated in the cleaning and measuring system.



If a cleaning solution connection is not used, it must be sealed with the supplied plug.

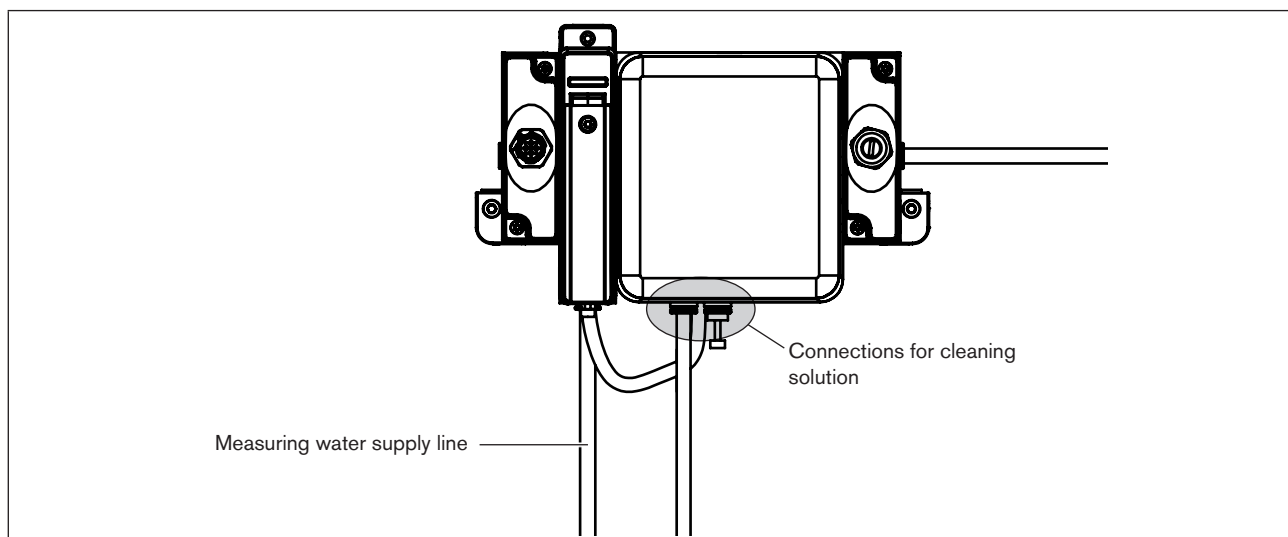

Figure 4: Cleaning system Type 8905: Fluid connection cleaning solution

## 7.3 Electrical connection

### CAUTION!

#### Risk of electric shock.

- ▶ If a 21.6...26.4 V DC version is installed in a damp environment, all electrical voltages may be max. 26.4 V DC.
- ▶ Before starting work, switch off all power supplies connected to the device and secure to prevent unintentional reactivation.
- ▶ Observe applicable accident prevention and safety regulations for electrical equipment.

### 7.3.1 Operating voltage

The device can be operated via an existing büS network or an external power supply at an operating voltage between 21.6 and 26.4 V.

To operate the device via an external power supply, the operating voltage and the büS communication are separated on the feed-in module using a Y-distributor with voltage interruption.

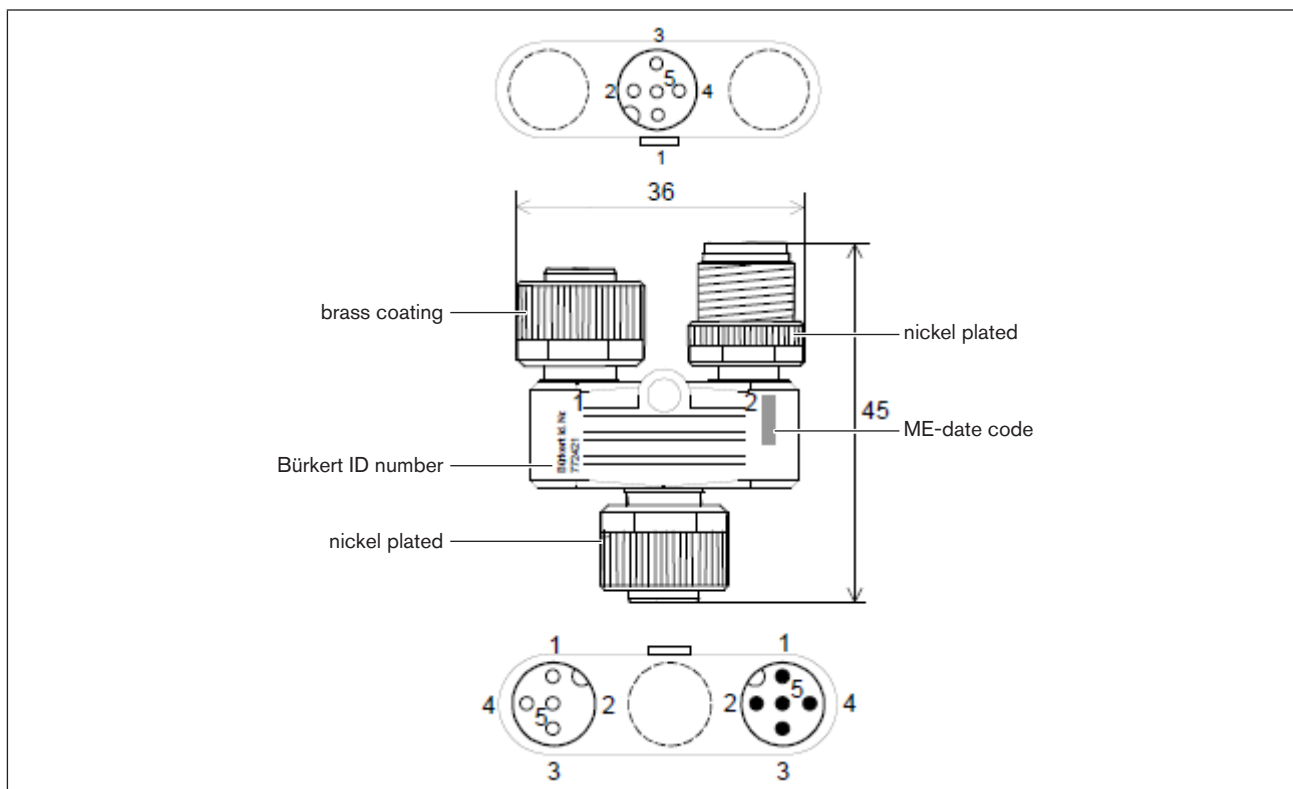

Figure 5: Y-distributor with voltage interruption

An appropriate cable with an M12 socket is required to connect the supply voltage.

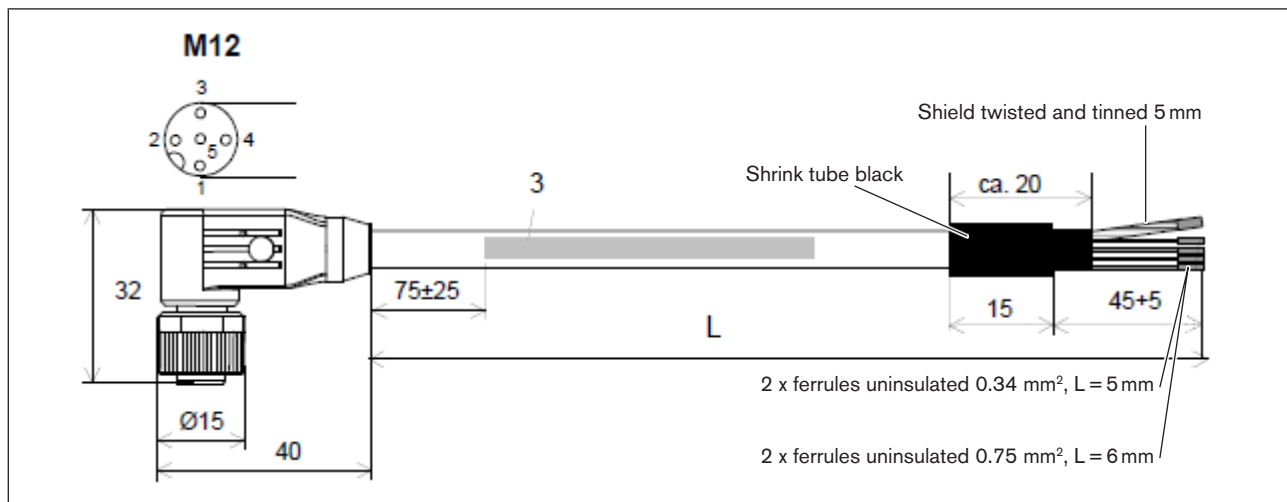

Figure 6: Example M12 connection cable, length 70 cm

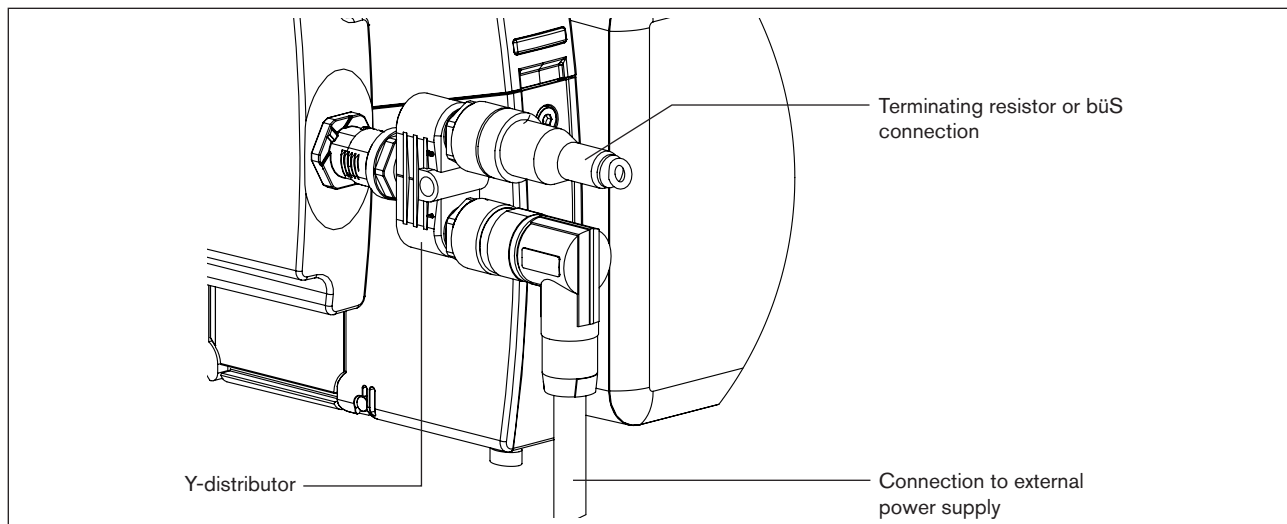

Figure 7: Example electrical connection with Y-distributor

All connection components are available via the accessories program (see "12 Accessories" on page 30)

### 7.3.2 Connection device communication

Communication with other devices is via bus. To connect the cleaning system to an existing bus network, e.g. an online analysis system, the device is connected to the respective last output module via an assembled bus cable. The bus is terminated with plug-in resistors on the last output module. The Y-distributor in the cleaning system is delivered with a plugged-in terminating resistor.

## 8 START-UP

A measuring system with display or the Bürkert communications software Communicator is required to start up the device.

### Prerequisites of measuring system with display:

- Installed controller software A.05.02.00

### Prerequisites of Communicator:

- Installed Communicator 2.0 or higher
- bÜS stick with connection cable (accessories)

If the device is not detected, the current driver must be copied into the driver directory `%APPDATA%/Buerkert/Communicator/DeviceDrivers`.

The stated versions are important for detecting and starting up the cleaning system.



Further information can be found at the following link:

<http://www.burkert.com/en/more-about/EDIP-Efficient-Device-Integration-Platform>

As soon as the cleaning system has been connected correctly to the bÜS network, it is automatically detected by the measuring system with display or by the Communicator.

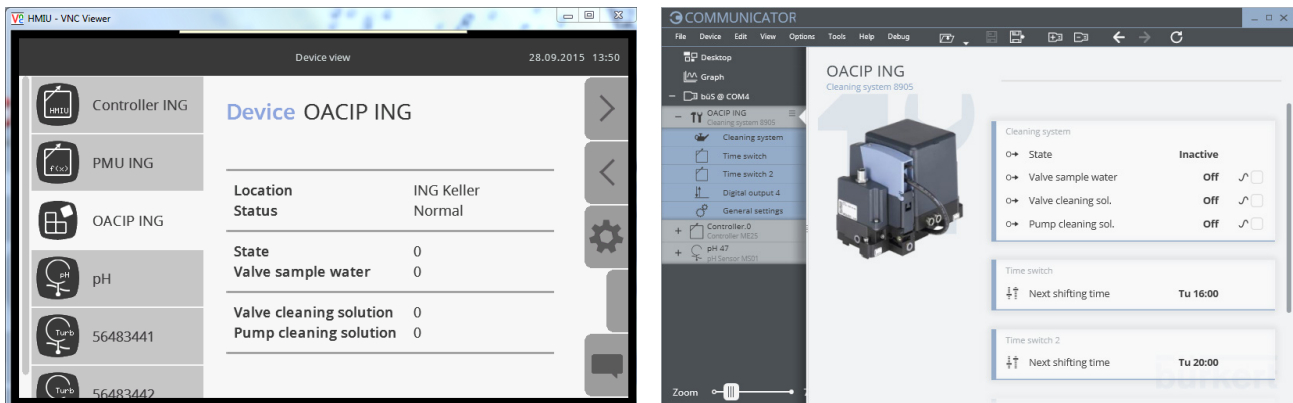

Figure 8: When the cleaning system has been correctly connected to the bÜS network, the device view automatically appears on the display of the measuring system (on left) or on the screen of the PC with Communicator software (on right).

As the filling capacity of the cleaning solution is not known, the error message "Cleaning solution is empty" appears. The filling capacity must be entered during start-up (see "Set volume of cleaning solution" on page 20).

A rights system is implemented in the Communicator and in the measuring system with display and controls access to the different levels.

User profile	Rights	Password
User	Read access only	No password required
Advanced user	Simple parameterizations	5678 (Initial password, must be changed during start-up)
Installer	All parameterizations and maintenance	1946 (Initial password, must be changed during start-up)
Bürkert	Access to factory settings, not available in the field	Device-specific



## 9 OPERATION ON THE MEASURING SYSTEM WITH DISPLAY

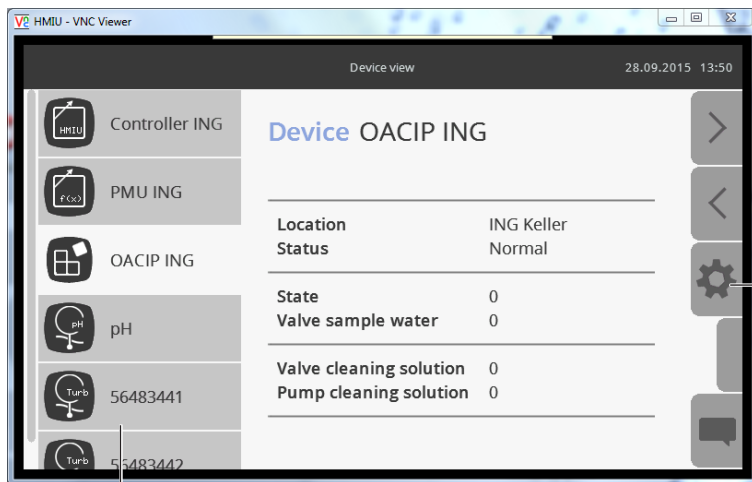

Change to function view

Navigation area

→ To parameterize the cleaning system, activate the device in the navigation area.

→ Change to Function view by clicking the button on the right.

The following function views are available:

- **Function būs** – parameterization of device-specific options
- **Function cleaning system** – parameterization of the cleaning cycle
- **Function time switch** – parameterization of the cleaning times
- **Function of Digital output 4** – 4. PWM output for controlling external devices (e.g. valve)

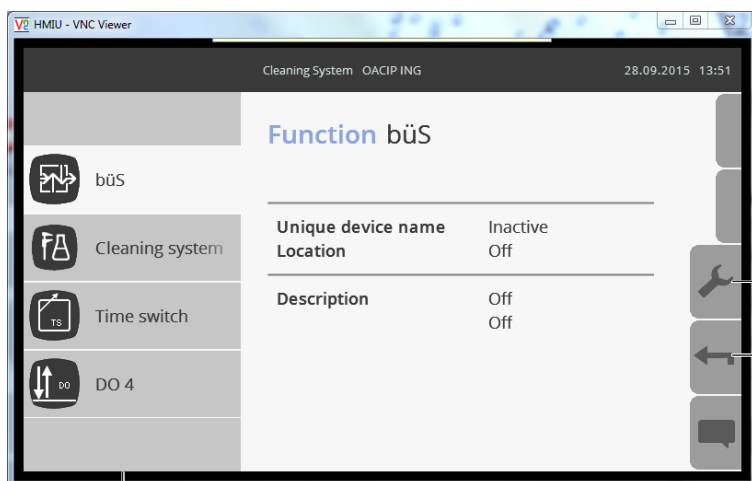

Change to detailed view

1 level back

Navigation area

→ In the Function view change to detailed view by clicking the button on the right.

The following detailed views are available:

- **Diagnostics**
- **Parameter**
- **Maintenance**

## 9.1 Parameterizing the büS function

The settings in the **büS** function are basic büS settings which are described separately in the instructions of the online analysis system.

## 9.2 Parameterizing the cleaning system function

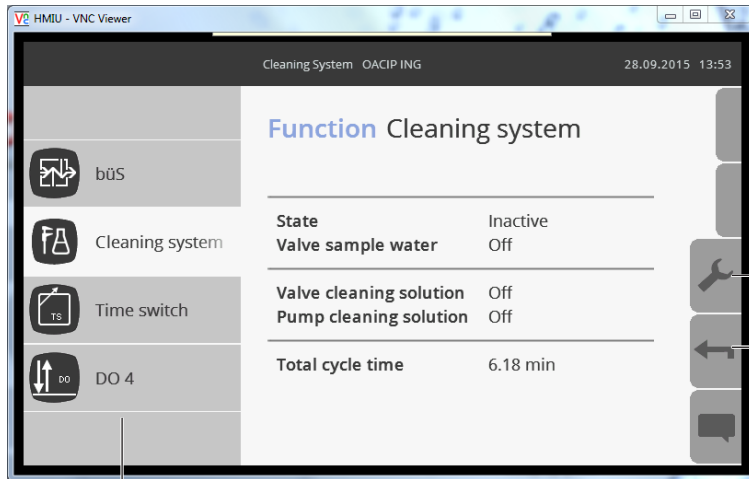

Navigation area

Change to detailed view

1 level back

→ Change to **Cleaning system diagnostics** detailed view

The status data of the cleaning system is displayed in the **Cleaning system diagnostics** detailed view.

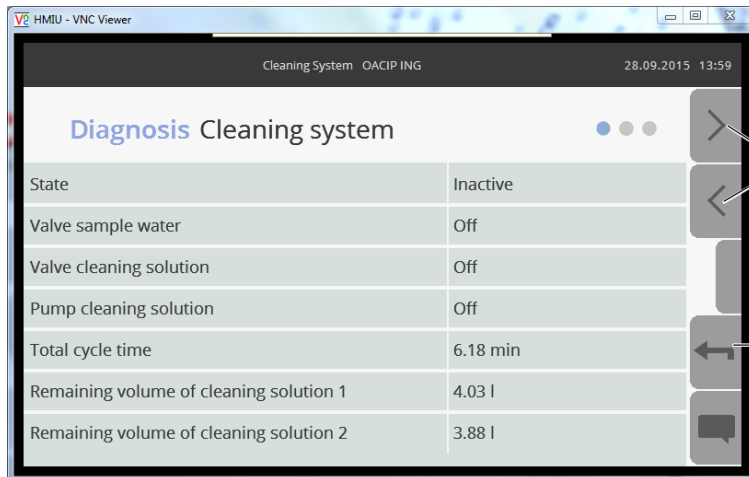

Switch between detailed views

1 level back

- **State:**

- 0 = no cleaning
- 1 = cleaning solution 1
- 2 = cleaning solution 2

- **Valves and pump**

Display of switching states

- **Total cycle time**

Time from the start of the announcement time to the end of the rinsing time. The state (1 or 2) is set in the total cycle time.

▪ **Residual quantities (remaining volume)**

Residual quantities are calculated by the system based on the set cleaning solution quantity, the pump flow rate and the pumping time.

→ Change to **Cleaning system parameters** detailed view

The complete cleaning cycle can be parameterized in the **Cleaning system parameters** detailed view.

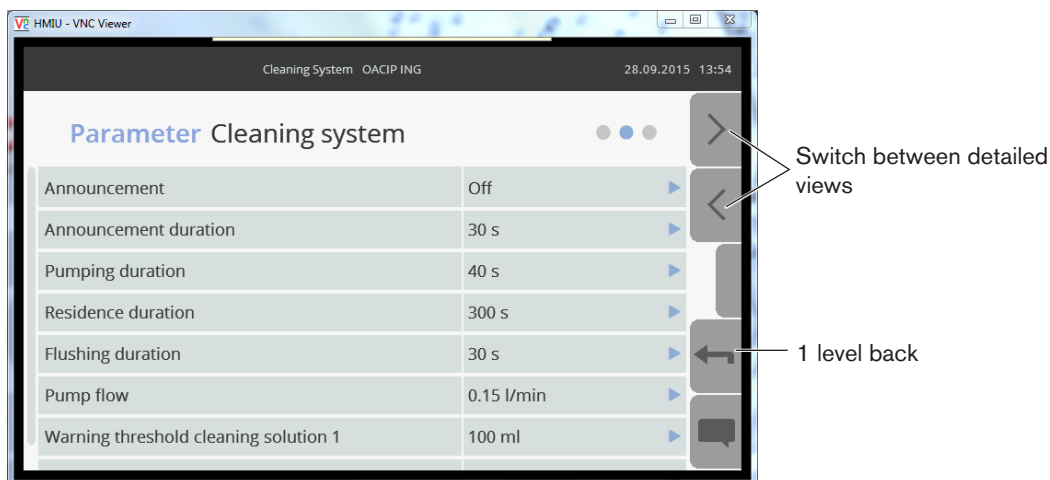

▪ **Announcement**

Selection On/Off (system message before cleaning)

▪ **Announcement duration (optional):**

Lead time before the cleaning cycle.  
Adjustable from 1 s to 300 s.

▪ **Pumping duration:**

Time during which the cleaning solution is pumped into the measuring system.  
Adjustable from 1 s to 120 s.  
Recommended for 5-fold system: 20 s.  
Extendable according to hose length and system size.

▪ **Residence duration:**

Reaction time of the cleaning solution in the system.

▪ **Flushing duration:**

Time after cleaning during which the system is rinsed.

▪ **Pump flow rate:**

Flow rate through the entire system.  
– Varies from system to system.  
– Must be calibrated, is implemented with user profile of installer.

▪ **Warning threshold cleaning solution 1 and 2**

If the alert threshold drops below the minimum, warnings are output according to chapter "11.2.1".

The buttons >< on the right edge of the display can be used to switch between the detailed views.

→ Change to **Cleaning system maintenance** detailed view

Manual actions can be implemented in the **Cleaning system maintenance** detailed view.

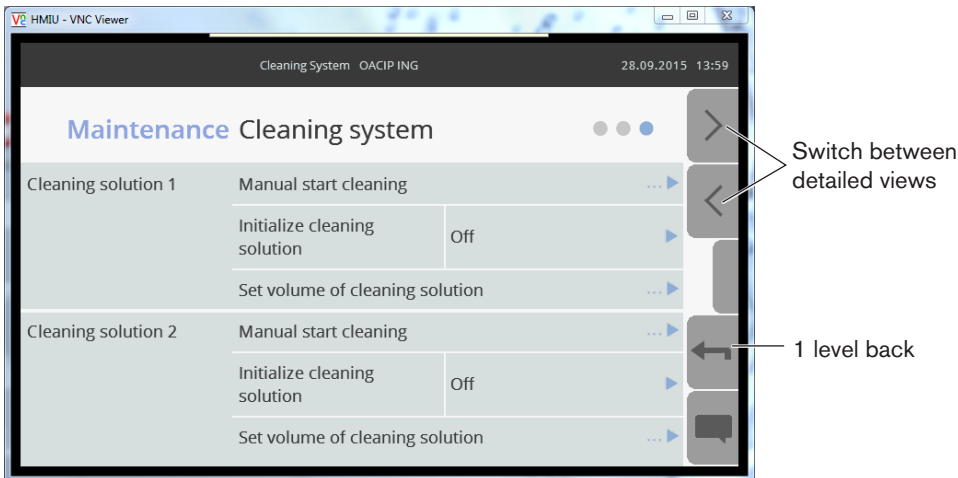

### Cleaning solution 1 / cleaning solution 2

- **Manual start cleaning:**  
Actuating manual start of the cleaning sequence
- **Initialize cleaning solution:**  
30 s pumping time to initially fill the empty connecting hoses
- **Set volume of cleaning solution:**  
Set filling level of the cleaning solutions. This information is important for warning messages.

## 9.3 Parameterizing the time switch function

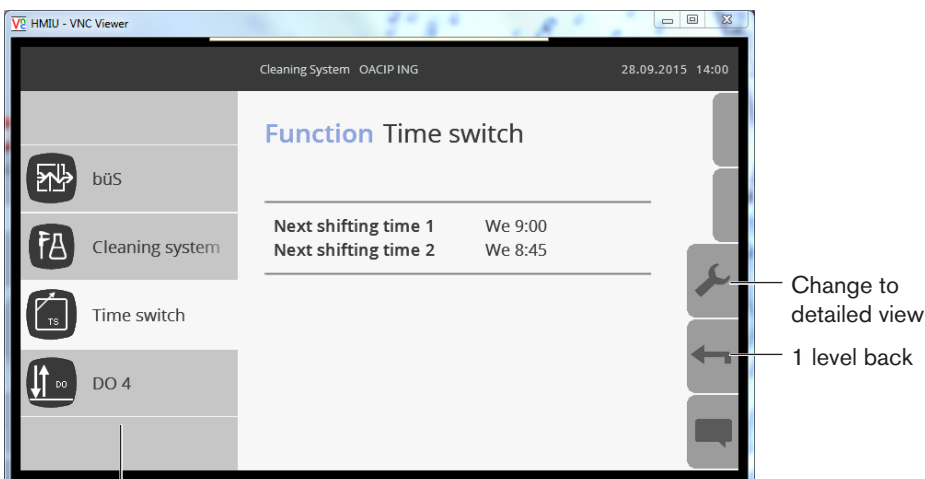

Navigation area

→ Change to **Time switch diagnostics** detailed view

## Type 8905 cleaning system

Operation on the measuring system  
with display

The switching states of the time switch outputs (ON/OFF) are displayed in the **Time switch diagnostics** detailed view.

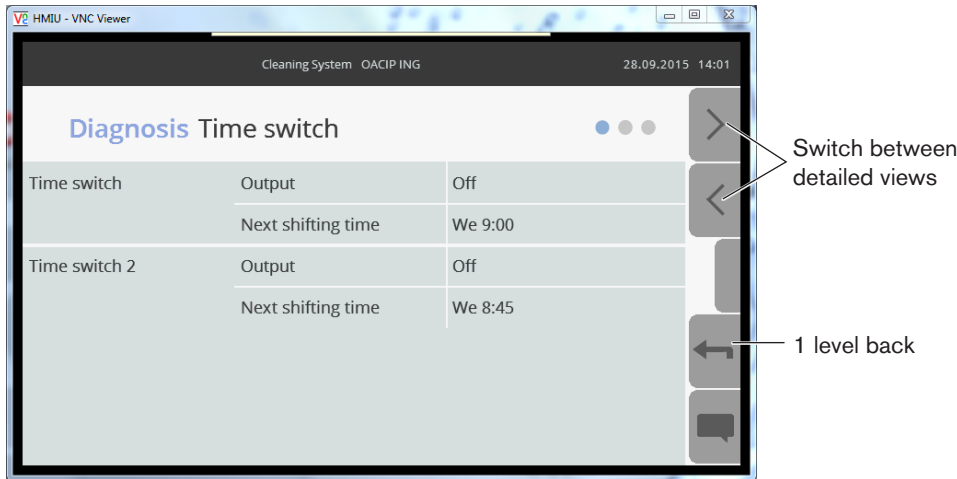

→ Change to **Time switch parameters** detailed view.

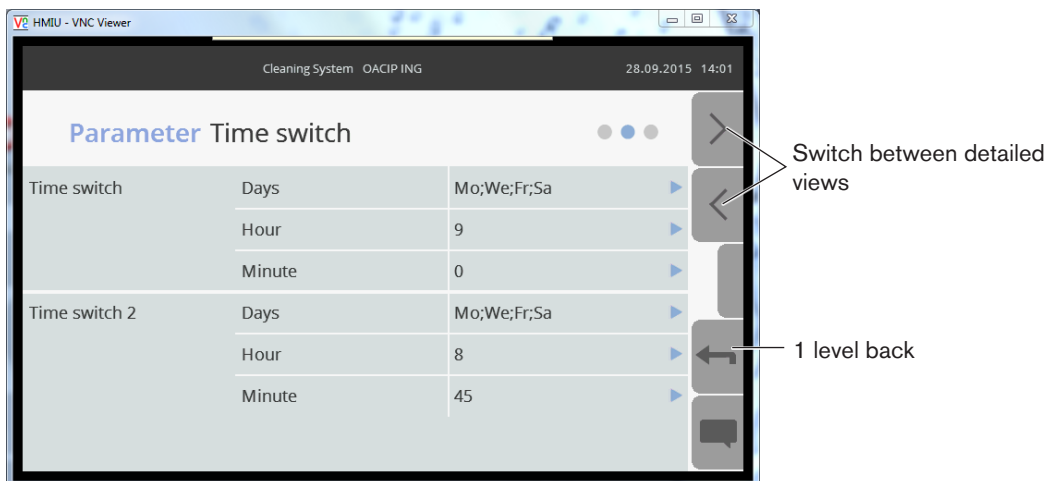

1 or 2 time switches are available depending on the number of cleaning solutions. Each time switch controls 1 cleaning sequence based on the set parameters. This enables different cleaning solutions to be controlled.

**Important: The time is specified in UTC time.**

→ Change to **Time switch maintenance** detailed view.

The timer outputs (ON/OFF) are manually switched in the **Time switch maintenance** detailed view.

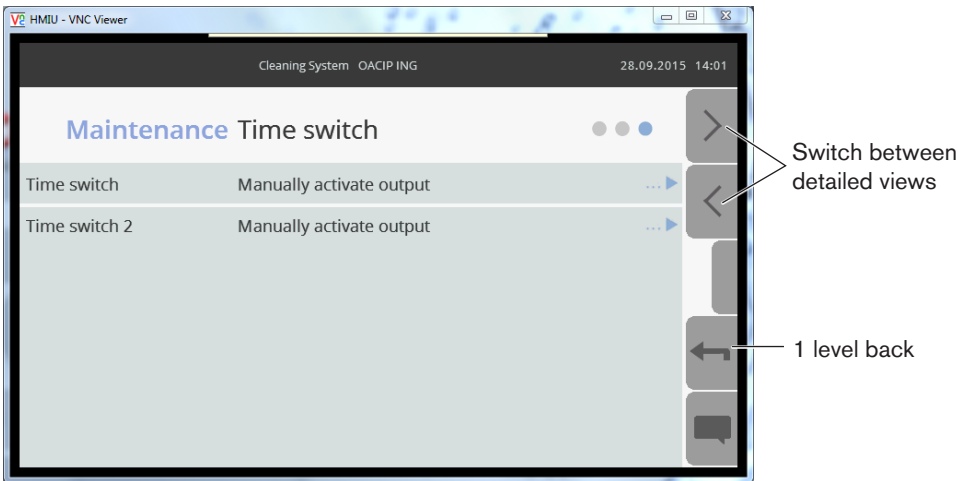

To prevent a cleaning process from starting unintentionally by manual activation of an output, the input must be confirmed:

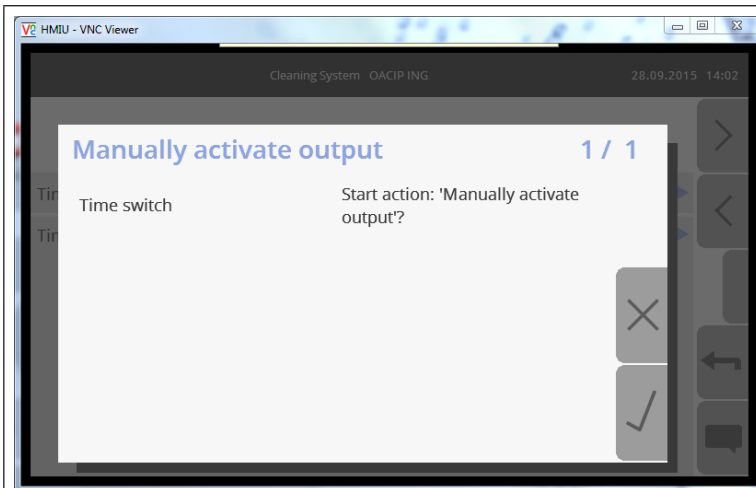

## 9.4 Parameterizing the Digital output 4 function

The digital output 4 can be used freely by the user. A detailed description can be found in the instructions for Type ME24, control module.

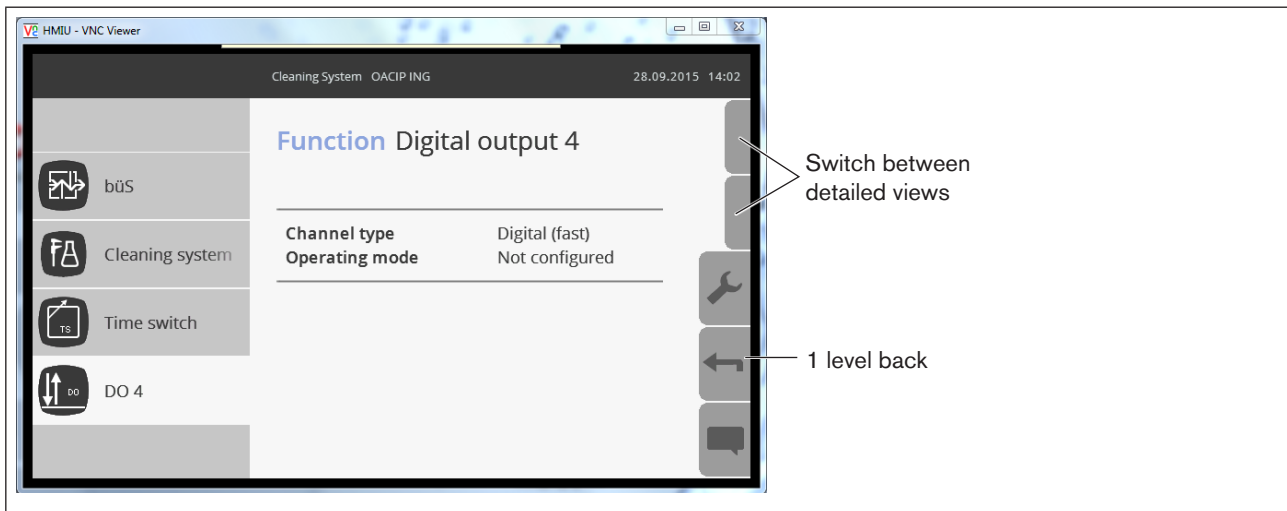

Each value available via the büS connection can be assigned to the switching output. The name is freely definable. It should be clear and unique. Depending on the selection, which value is monitored by the digital output, a parameterization of the required function is possible.

In the example shown the output is connected as long as the conductivity value remains within the limits specified by the user.

## 10 OPERATION OF THE CLEANING SYSTEM

The quality of the measuring water may soil the sensors of the measuring system. Examples of soiling are limescale, iron deposits or growth of algae.

To ensure continuously good measurements, clean the sensors at equal intervals irrespective of the quality of the measuring water. Use only cleaning solutions approved and specified by Bürkert: acidic, alkaline and neutral solutions.

### 10.1 Recommended cleaning to remove iron deposits and limescale

- Start cleaning with an acidic cleaning solution.
- Ensure that all sensors are filled with cleaning solution.
- Pumping time: 20 s (for a standard measuring system with 5 sensors and a 0.5 m hose supply line)

Indicators for an adequate filling are changes to the measured values of the sensors. In particular, the values for turbidity, pH value and conductivity respond:

sensor	Change in value with acidic solution	Change in value with alkaline solution
Turbidity	increasing	increasing
pH value	approx. 3.5	approx. 11
Conductivity	approx. 500 $\mu\text{S}/\text{cm}$	approx. 5000 $\mu\text{S}/\text{cm}$
ORP	–	–
Chlorine	–	–

Table 1: Change in the measured value during cleaning operation

The cleaning result is influenced by the following factors:

- Adequate filling of the sensors.
- Dwell time of the cleaning solution in the sensor.  
Cleaning occurs when the calcium carbonate reacts with the acidic cleaning solution.  
**The longer the dwell time, the better the cleaning result.**
- Number of cleaning procedures per week.  
The number depends to a great extent on the available measuring water.  
**The harder the water or the more iron dissolved in the water, clean more often and for longer.**



Clean once or twice for maximum 5 minutes. If the cleaning result is not satisfactory, clean more often or for longer.

If a chlorine sensor is used, go for a short dwell time. The service life of the sensor is reduced by contact with acidic cleaning solution.



MAN 1000268359 EN Version: B Status: RL (released | freigegeben) printed: 22.09.2017

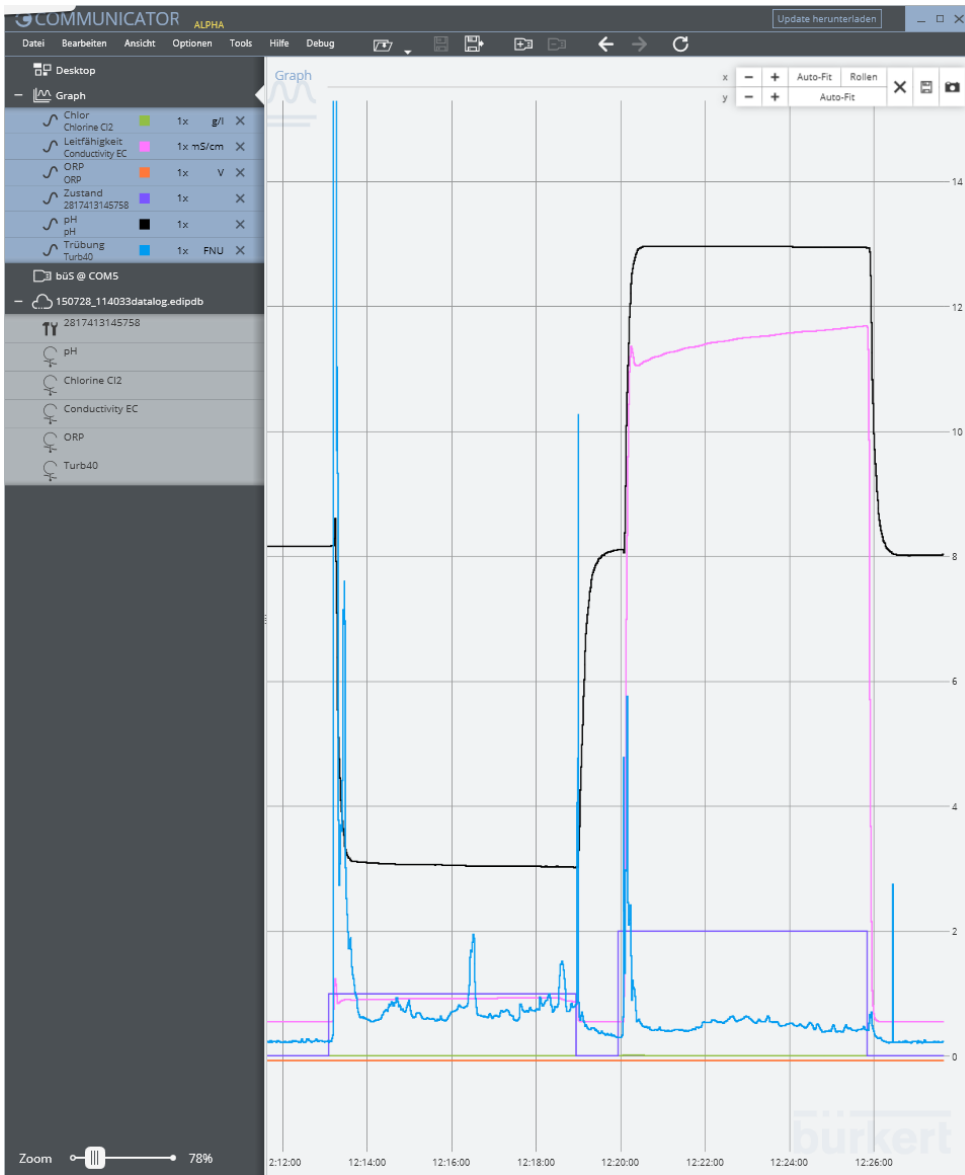
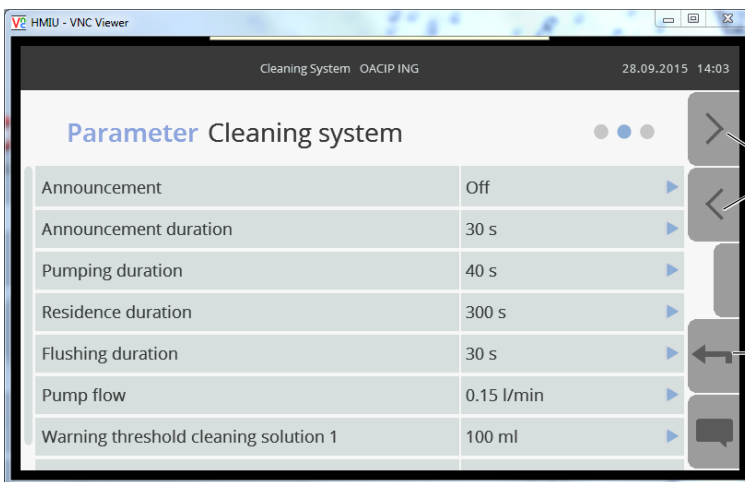

Figure 9: Combination cleaning alkaline cleaning solution for acidic, standard parameters



Switch between detailed views

1 level back

Figure 10: Standard parameters for cleaning operation for iron deposits and limescale

### **Combined cleaning**

To improve the cleaning result, use combinations of different cleaning agents. To do this, a cleaning system for 2 cleaning solutions is required. Simple cleaning systems can be activated by updating the software.

An effective combination is the alkaline cleaning solution with the acidic cleaning solution. Observe a rinsing time of at least 30 s for combined cleaning.

It is not necessary to do the alkaline cleaning during the same cleaning interval. A longer interval is possible here, e.g.:

- 2 x cleaning with acidic cleaning solution,
- 1 x combined cleaning.

## **10.2 Recommended cleaning for organic soiling**

Remove organic soiling with alkaline cleaning solution. The same optimization rules apply here as for the removal of limescale and iron deposits.

# 11 MAINTENANCE

## CAUTION!

### Risk of electric shock.

- ▶ If a 21.6...26.4 V DC version is installed in a damp environment, all electrical voltages may be max. 26.4 V DC.
- ▶ Before starting work, switch off all power supplies connected to the device and secure to prevent unintentional reactivation.
- ▶ Observe applicable accident prevention and safety regulations for electrical equipment.

### Danger – high pressure in the equipment.

- ▶ Before detaching the process connections, depressurize the equipment and stop the liquid circulation.

### Danger due to cleaning solution.

- ▶ When working with cleaning solutions, follow the instructions on the safety data sheet provided.
- ▶ When working with cleaning solutions, wear personal protective equipment.

Maintenance work is:

- Setting cleaning parameters
- Changing container cleaning solution

The cleaning solution **can** be topped up after the 1st warning message "Low cleaning solution level" and **must** be topped up after the error message "Too little cleaning solution for a complete cleaning sequence" (see "11.2 Warning and error messages" on page 28).



If there is still cleaning solution in the container, the pump flow rate of the cleaning system has been incorrectly set. In this case the pump flow rate must be recalculated (see chapter "9.2").

## 11.1 Changing container cleaning solution

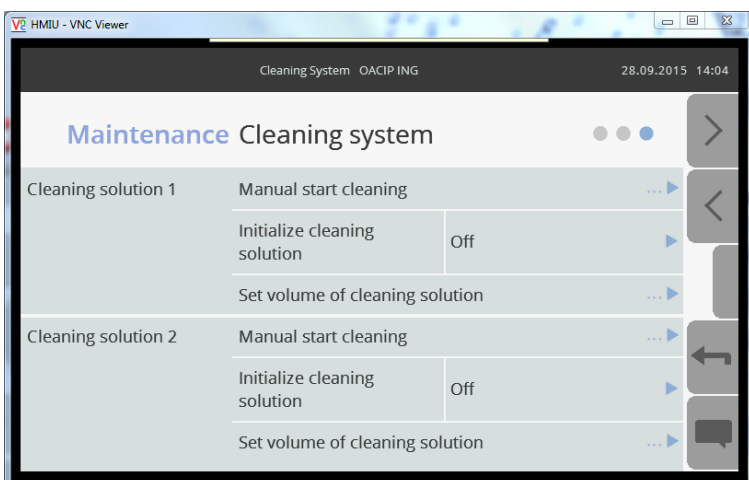

- Replace tank with cleaning solution.
- Reset the filling level using the measuring system or the Communicator in the Maintenance menu of the cleaning system.
- Initialize the cleaning solution in the Maintenance menu.  
This will pump any air out of the cleaning system. During the initialization sequence the cleaning system pumps cleaning solution through the measuring system for 30 s.



When disposing of cleaning solution, follow the instructions on the safety data sheet provided.

## 11.2 Warning and error messages

All Bürkert devices feature LED display elements to visualize the device status. The colors and symbols of the display elements have been designed in accordance with NAMUR recommendation 107.







Display element	Meaning	Type
	OK	
	Diagnostics	
	Maintenance required	Warning
	Outside the specification	
	Function check	Warning
	Error case	Error

Figure 11: Display of the device status according to NAMUR recommendation 107

All statuses are displayed on the device in question and on a higher-level system (e.g. on the measuring system).

### 11.2.1 Warning messages cleaning system

Existing warning messages are visualized with the envelope at top left and displayed in a message list.

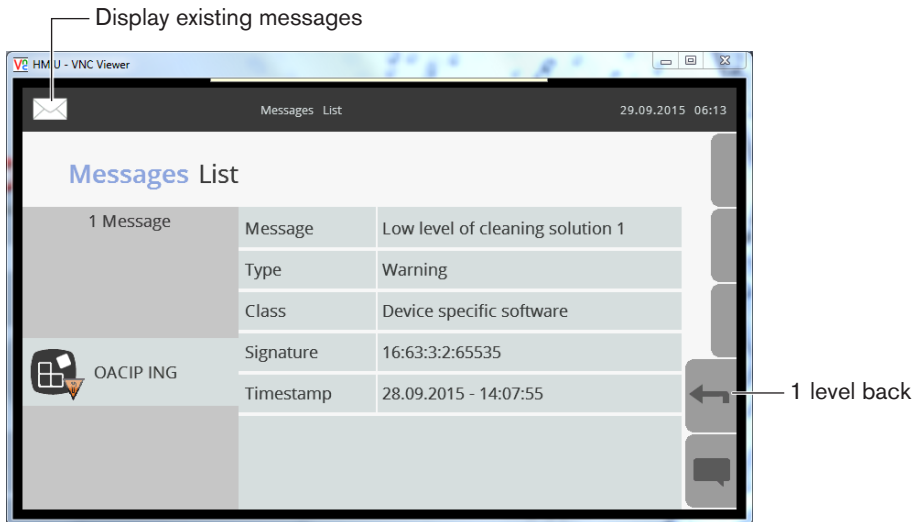

Message	Meaning
Low level of cleaning solution	Low filling level, but cleaning can still be run

### 11.2.2 Error messages cleaning system

Existing error messages are visualized with the envelope at top left and displayed in a message list.

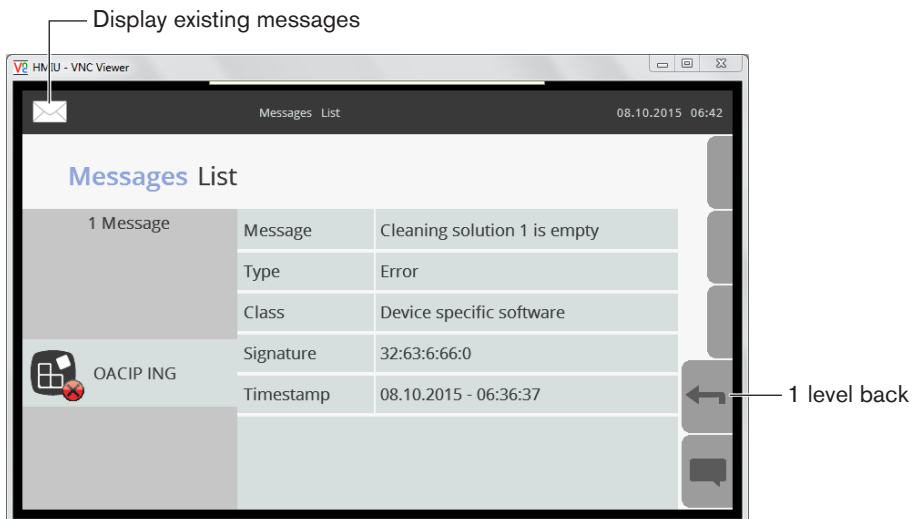

Message	Meaning
Too less cleaning solution for a complete cleaning cycle	Cleaning is not run.
Cleaning solution is empty (1 / 2)	Cleaning is not run.

MAN 1000268359 EN Version: B Status: RL (released | freigegeben) printed: 22.09.2017

## 12 ACCESSORIES

Cleaning solutions		Capacity (in ml)	Order no.
	Cleaning Solution, acidic	250	807478
	Cleaning Solution, acidic	1000	807479
	Cleaning Solution, acidic	5000	807480
	Cleaning Solution, alkaline	250	807486
	Cleaning Solution, alkaline	1000	807487
	Cleaning Solution, alkaline	5000	807489

Electrical connection technology		Length (in m)	Order no.
	büS cable extension, straight plug/straight socket	1	772404
	büS cable extension, straight plug/straight socket	3	772405
	büS cable extension, straight plug/straight socket	5	772406
	büS connection cable, open/straight socket	1	772409
	büS connection cable, open/straight socket	3	772410
	büS connection cable, open/straight socket	5	772411
	büS connection cable, open/angled socket	0.7	772626
	büS plug M12, angled		772419
	büS Y-distributor		772420
	büS Y-distributor with voltage interruption		772421
	büS stick set 1: Case with stick, cables and power supply		772426
	büS stick set 2: Stick and cable		772551

Other installation material		Length (in m)	Order no.
	Measuring water hose 4/6 mm	5	567060
	Measuring water hose 4/6 mm	10	567061
	Measuring water hose 4/6 mm	25	567062
	Set consisting of 1 pressure reducing valve (incl. 100-mm filter, sampling point, 2 connections G1/4") 1 wall holder with nut (for the pressure reducing valve) 1 pressure gauge (for the pressure reducing valve) and two quick-release couplings		566319

## 13 DISASSEMBLY

### CAUTION!

#### Risk of electric shock.

- ▶ If a 21.6...26.4 V DC version is installed in a damp environment, all electrical voltages may be max. 26.4 V DC.
- ▶ Before starting work, switch off all power supplies connected to the device and secure to prevent unintentional reactivation.
- ▶ Observe applicable accident prevention and safety regulations for electrical equipment.

#### Danger – high pressure in the equipment.

- ▶ Before detaching the process connections, depressurize the equipment and stop the liquid circulation.

#### Danger due to cleaning solution.

- ▶ When working with cleaning solutions, follow the instructions on the safety data sheet provided.
- ▶ When working with cleaning solutions, wear personal protective equipment.

→ Pump the cleaning solution out of the hoses.

→ Take container with the cleaning solution out of the cleaning system.

→ In the Cleaning system maintenance menu initialize the cleaning solution (see "[Initialize cleaning solution](#)" on page 20).

→ Disconnect electrical connections.

## 14 TRANSPORTATION, STORAGE, DISPOSAL

### NOTE!

#### Transport damage

Inadequately protected devices may be damaged during transportation.

- ▶ Protect the device against moisture and dirt in shock-resistant packaging during transportation.
- ▶ Prevent the temperature from exceeding or dropping below the permitted storage temperature.

#### Damage caused by incorrect storage

- ▶ Store the device in a dry and dust-free location. Storage temperature  $-40...+55$  °C.

#### Disposal of cleaning solutions

- ▶ When disposing of cleaning solutions, follow the instructions on the safety data sheet provided.

#### Damage to the environment caused by parts contaminated with media

- ▶ Dispose of the device and packaging in an environmentally friendly manner.
- ▶ Observe applicable disposal and environmental regulations.







